

aprilia

1325 6

05/2006-00

Scarabeo 500

www.serviceaprilia.com

workshop manual



8181024

INTRODUCTION

SUMMARY

0.1. INTRODUCTION 3
0.1.1. FOREWORD 3
0.1.2. REFERENCE MANUALS 4
0.1.3. ABBREVIATIONS/SYMBOLS/CONVENTIONS 5

0.1. INTRODUCTION

0.1.1. FOREWORD

This manual provides the information required for normal servicing.

This publication is intended for use by **aprilia** Dealers and their qualified mechanics; many concepts have been omitted on purpose as their inclusion would be superfluous. Since complete mechanical explanations have not been included in this manual, the reader must be familiar with basic notions of mechanics, as well as with basic repair procedures. Without such familiarity, repairs and checks could be ineffective and even hazardous. Since the repair and vehicle check instructions are not exhaustive, special care must be taken to avoid damage and injury. **Piaggio & C. S.p.A.** undertakes to constantly improve the design of its products and the relevant literature to ensure maximum customer satisfaction. The main technical modifications and changes in repair procedures are communicated to all **aprilia** dealers and agencies worldwide. Such modifications will be entered in subsequent editions of the manual. Should you need assistance or clarifications about the inspection and repair procedures, please contact the **aprilia** SERVICE DEPT., they will be glad to give you any information on the matter, or supply you with any detail on updates and technical changes applied to the vehicle.

Piaggio & C. S.p.A. reserves the right to make changes to its products at any time, barring any such changes as may alter the essential features of a product as specified in the relevant manual.

All rights of storage using electronic means, reproduction and total or partial adaptation, whatever the means adopted, are reserved in all countries.

Third parties' products are only mentioned for information purposes, and constitute no engagement.

Piaggio & C. S.p.A. is not liable in any way for the performance or use of these products.

First edition: May 2006

Produced and printed by:

DECA s.r.l.

via Vincenzo Giardini, 11 - 48022 Lugo (RA) - Italy

Tel. +39 - 0545 216611

Fax +39 - 0545 216610

E-mail: deca@vftis.spx.com

www.vftis.com

on behalf of:

Aprilia

via G. Galilei, 1 - 30033 Noale (VE) - Italy

Tel. +39 – (0)41 58 29 111

Fax +39 – (0)41 58 01 674

www.aprilia.com

0.1.2. REFERENCE MANUALS

OWNER'S MANUALS

aprilia part# (description)	
8181030	I
8181031	F D E UK NL
8181032	DK SF GR

SPARE PARTS CATALOGUE

aprilia part# (description)	
6836	I E F D UK

CHASSIS WORKSHOP MANUAL

aprilia part# (description)	
8181020	I
8181021	F
8181022	D
8181023	E
8181024	UK

ENGINE TECHNICAL MANUAL

aprilia part# (description)	
8140868	I
8140869	F
8140870	D
8140871	E
8140872	UK

ENGINE CD

aprilia part# (description)	
8CM0105	I E F D UK

CHASSIS CD

aprilia part# (description)	
8CM0107	I E F D UK

0.1.3. ABBREVIATIONS/SYMBOLS/CONVENTIONS

#	= number
<	= less than
>	= greater than
≤	= less than or equal to
≥	= more than or equal to
~	= approximately
∞	= infinity
°C	= degrees Celsius (centigrade)
°F	= degrees Fahrenheit
±	= plus or minus
a.c	= alternating current
A	= Ampere
Ah	= Ampere per hour
API	= American Petroleum Institute
AT	= high voltage
AV/DC	= Anti-Vibration Double Countershaft
bar	= pressure measurement unit (1 bar = 100 kPa)
d.c.	= direct current
cc	= cubic centimetres
CO	= carbon monoxide
CPU	= Central Processing Unit
DIN	= German industrial standards (Deutsche Industrie Norm)
DOHC	= Double Overhead Camshaft
ECU	= Electronic Control Unit
rpm	= revolutions per minute
HC	= unburnt hydrocarbons
ISC	= Idle Speed Control
ISO	= International Standardisation Organisation
kg	= kilograms
kgm	= kilograms per metre (1 kgm = 10 Nm)
km	= kilometres
km/h	= kilometres per hour
kΩ	= kilo Ohm
kPa	= kiloPascal (1 kPa = 0.01 bar)
KS	= clutch side (from the German "Kupplungsseite")
kW	= kilowatt
ℓ	= litres
LAP	= racetrack lap
LED	= Light Emitting Diode
LEFT	
SIDE	= left side
m/s	= metres per second
max	= maximum
mbar	= millibar (1 mbar = 0.1 kPa)
mi	= miles
MIN	= minimum
MPH	= miles per hour
MS	= flywheel side (from the German "Magnetseite")
MΩ	= MegaOhm
N.A.	= Not Available
N.O.M.M.	= Motor Octane Number
N.O.R.M.	= Research Octane Number
Nm	= Newton metre (1 Nm = 0.1 kgm)
Ω	= ohm
PICK-UP	= pick-up
BDC	= Bottom Dead Centre
TDC	= Top Dead Centre
PPC	= Pneumatic Power Clutch

RIGHT	
SIDE	= right side
SAE	= Society of Automotive Engineers
TEST	= diagnostic check
T.B.E.I.	= crown-head Allen screw
T.C.E.I.	= cheese-head Allen screw
T.E.	= hexagonal head
T.P.	= flat head screw
TSI	= Twin Spark Ignition
UPSIDE-	
DOWN	= inverted fork
V	= volt
W	= watt
Ø	= diameter

GENERAL INFORMATION

1

SUMMARY



1.1. STRUCTURE OF THE MANUAL..... 3
1.1.1. CONVENTIONS USED IN THE MANUAL 3
1.1.2. SAFETY WARNINGS..... 4
1.2. GENERAL RULES..... 5
1.2.1. BASIC SAFETY RULES..... 5
1.3. DANGEROUS ELEMENTS 8
1.3.1. WARNINGS 8
1.4. RUNNING-IN 11
1.4.1. RUNNING-IN..... 11
1.5. VEHICLE IDENTIFICATION 12
1.5.1. POSITION OF THE SERIAL NUMBERS 12

1.1. STRUCTURE OF THE MANUAL





1.1.1. CONVENTIONS USED IN THE MANUAL

- This manual is divided in sections and subsections, each covering a set of the most significant components. Refer to the index of sections when consulting the manual.
- Unless expressly specified otherwise, assemblies are reassembled by reversing the dismantling procedure.
- The terms "right" and "left" are referred to the rider seated on the vehicle in the normal riding position.
- Motorcycle operation and basic maintenance are covered in the "OWNER'S MANUAL".

In this manual any variants are identified with these symbols:

-  optional
-  catalytic version
- all versions
- MP national certification
- SF European certification (EURO 2 limits)

VERSION:

 Italy	 Greece	 Malaysia
 United Kingdom	 Holland	 Chile
 Austria	 Switzerland	 Croatia
 Portugal	 Denmark	 Australia
 Finland	 Japan	 United States of America
 Belgium	 Singapore	 Brazil
 Germany	 Slovenia	 South Africa
 France	 Israel	 New Zealand
 Spain	 South Korea	 Canada

1.1.2. SAFETY WARNINGS

The following precautionary warnings are used throughout this manual in order to convey the following messages:



Safety warning. This symbol appears, whether in the manual or on the vehicle itself, to indicate a personal injury hazard. Non-compliance with the indications given in the messages preceded by this symbol may result in serious risks for your and other people's safety and for the vehicle!

**DANGER**

Indicates a potential hazard which may result in serious injury or even death.

**WARNING**

Indicates a potential hazard which may result in minor personal injury or damage to the vehicle.

NOTE The word "NOTE" in this manual precedes important information or instructions.

1.2. GENERAL RULES

1.2.1. BASIC SAFETY RULES

CARBON MONOXIDE

Should it be necessary to perform some operations with the vehicle running, make sure to work outdoors or in a well-aerated room.

Avoid starting the engine indoors.

In case you are working indoors, use a gas exhaust system.



DANGER

Exhaust gases contain carbon monoxide, which is extremely toxic if inhaled and may cause loss of consciousness or even lead to death.

FUEL



DANGER

The fuel used in internal combustion engines is highly flammable and can become explosive under particular conditions.

Refuelling and engine service should take place in a well-ventilated area with the engine stopped.

Do not smoke when refuelling or in the proximity of sources of fuel vapours, avoid flames, sparks and any element that could ignite fuel or provoke explosions.

DO NOT DISPOSE OF FUEL IN THE ENVIRONMENT.

KEEP AWAY FROM CHILDREN.

HIGH-TEMPERATURE COMPONENTS

The engine and the components of the exhaust system become very hot and remain hot for some time after the engine has been stopped.

Before handling these components, wear insulating gloves or wait until the engine and the exhaust system have cooled down.

USED GEARBOX AND FORK FLUIDS



DANGER

Wear latex gloves when servicing.

Gear fluid may cause serious damage to the skin if handled daily and for long periods.

Wash your hands carefully after handling engine oil.

Take it to the filling station where you usually buy it or to an oil salvage centre.

Wear latex gloves when servicing.

DO NOT DISPOSE OF FLUID IN THE ENVIRONMENT

KEEP AWAY FROM CHILDREN.

BRAKE FLUID



WARNING

When handling the brake fluid, take care not to spill it on the plastic, rubber or painted parts, since it can damage them. When carrying out the maintenance operations on the braking system, use a clean cloth to cover these parts.

Always wear safety goggles when working on the braking system.

The brake fluid is highly irritant. Avoid contact with your eyes.

If the brake fluid gets in contact with your eyes, carefully wash them with fresh water and immediately seek medical advice.

KEEP AWAY FROM CHILDREN.

COOLANT

Coolant contains ethylene glycol that is flammable, under certain conditions. When ignited, ethylene glycol produces invisible flames that might cause burns.

**DANGER**

Take care not to spill coolant onto hot engine parts and exhaust system. It may ignite and produce invisible flames.

Wear latex gloves when servicing.

Although toxic, it has a sweet taste that might attract animals. Never leave coolant in open container or in a position easily reachable by animals.

KEEP AWAY FROM CHILDREN.

Do not remove radiator cap when engine is still hot. Coolant is under pressure and might cause burns.

HYDROGEN GAS AND BATTERY ELECTROLYTE**DANGER**

The battery electrolyte is a toxic, caustic substance containing sulphuric acid and thus able to cause severe burns in case of contact with the skin.

Always wear tight gloves and protective clothes when handling this fluid.

In case of contact with skin, rinse with plenty of fresh water.

Always use a protection for your eyes since even a very small amount of the battery fluid can cause blindness. In the event of contact with your eyes, carefully wash them with water for fifteen minutes and then consult immediately an eye specialist.

Should you accidentally drink some fluid, drink abundant water or milk, then drink magnesia milk or vegetable oil and immediately seek medical advice.

The battery gives off explosive gases and must be kept away from flames and sources of ignition or heat; do not smoke near the battery.

KEEP AWAY FROM CHILDREN.

Battery fluid is corrosive.

Do not spill it, especially on plastic parts.

Make sure that the electrolyte is suitable for the type of battery used.

GENERAL PRECAUTIONS AND INFORMATION

Follow these instructions closely when repairing, disassembling or reassembling the motorcycle or its components.

**DANGER**

Using bare flames is strictly forbidden when working on the motorcycle. Before servicing or inspecting the motorcycle: stop the engine and remove the key from the ignition switch; allow for the engine and exhaust system to cool down; where possible, lift the motorcycle using adequate equipment placed on firm and level ground. Be careful of any parts of the engine or exhaust system which may still be hot to the touch to avoid scalds or burns.

Do not put any vehicle parts into your mouth: vehicle components are not edible and some of them are harmful or even toxic.

Unless expressly specified otherwise, assemblies are reassembled by reversing the dismantling procedure. Where a procedure is cross-referred to relevant sections in the manual, proceed sensibly to avoid disturbing any parts unless strictly necessary. Do not polish matt-painted surfaces with polishing paste.

Never use fuel instead of solvent to clean the motorcycle.

Do not clean any rubber or plastic parts or the seat with alcohol, petrol or solvents. Clean with water and mild detergent.

Always disconnect the battery negative (-) lead before soldering any electrical components.

When two or more persons service the same motorcycle together, special care must be taken to avoid personal injury.

BEFORE DISASSEMBLING ANY COMPONENTS

- Clean off all dirt, mud, and dust and clear any foreign objects from the vehicle before disassembling any components.
- Use the model-specific special tools where specified.

DISASSEMBLING THE COMPONENTS

- Never use pliers or similar tools to slacken and/or tighten nuts and bolts. Always use the suitable spanner.
- Mark all connections (hoses, wiring, etc.) with their positions before disconnecting them. Identify each connection using a distinctive symbol or convention.
- Mark each part clearly to avoid confusion when refitting.
- Thoroughly clean and wash any components you have removed using a detergent with low flash point.
- Mated parts should always be refitted together. These parts will have seated themselves against one another in service as a result of normal wear and tear and should never be mixed up with other similar parts on refitting.
- Certain components are matched-pair parts and should always be replaced as a set.
- Keep away from heat sources.

REASSEMBLING THE COMPONENTS**DANGER**

Never reuse a circlip or snap ring. These parts must always be renewed once they have been disturbed.

When fitting a new circlip or snap ring, take care to move the open ends apart just enough to allow fitment to the shaft.

Make it a rule to check that a newly-fitted circlip or snap ring has located fully into its groove.

Never clean a bearing with compressed air.

NOTE All bearings must rotate freely with no hard spots or noise. Replace any bearings that do not meet these requirements.

- Use ORIGINAL **aprilia** SPARE PARTS only.
- Use the specified lubricants and consumables.
- Where possible, lubricate a part before assembly.
- When tightening nuts and bolts, start with the largest or innermost nut/bolt and observe a cross pattern. Tighten evenly, in subsequent steps until achieving the specified torque.
- Replace any self-locking nuts, gaskets, seals, circlips or snap rings, O-rings, split pins, bolts and screws which have a damaged thread.
- Lubricate the bearings abundantly before assembly.
- Make it a rule to check that all components you have fitted are correctly in place.
- After repairing the motorcycle and after each service inspection, perform the preliminary checks, and then test ride the motorcycle in a private estate area or in a safe area away from traffic.
- Clean all mating surfaces, oil seal edges and gaskets before assembly. Apply a thin layer of lithium grease along the edges of oil seals. Fit oil seals and bearings with the marking or serial number facing outwards (in view).

ELECTRICAL CONNECTORS

To disconnect the electrical connectors, follow the procedures below. Failure to comply with these procedures may lead to irreparable damage to the connector and the wiring as well.

If present, press the special safety hooks.

**WARNING**

Do not pull cables to disconnect the two connectors.

- Grasp the two connectors and disconnect them by pulling them in the two opposite directions.
- In case of dirt, rust, moisture, etc., thoroughly clean the inside of the connectors with compressed air.
- Make sure that the cables are correctly fitted inside the connector terminals.

NOTE The two connectors have just one correct positioning. Make sure to position them in the right direction.

- Then fit the two connectors. Make sure they are correctly coupled (a click will be heard if hooks are present).

TIGHTENING TORQUE SETTINGS**DANGER**

Always remember that the tightening torque settings of all wheel, brake, wheel shaft and other suspension parts play a fundamental role to ensure vehicle safety. Make sure that these values are always within the specified limits.

Check fastening parts tightening torque settings at regular intervals. Upon reassembly, always use a torque wrench.

Failure to comply with these recommendations could lead to the loosening and detachment of one of these parts with a consequent locking of the wheel or other serious troubles affecting the vehicle manoeuvrability, and thus the risk of falls and serious injuries or death.

1.3. DANGEROUS ELEMENTS

1.3.1. WARNINGS

FUEL

**DANGER**

The fuel used to operate engines is highly flammable and becomes explosive under particular conditions.

Refuelling and engine service should take place in a well-ventilated area with the engine stopped.

Do not smoke when refuelling or in the proximity of sources of fuel vapours, avoid flames, sparks and any element that could ignite fuel or provoke explosions.

Take care not to spill fuel out of the filler, or it may ignite when in contact with hot engine parts.

In the event of accidental fuel spillage, make sure the affected area is fully dry before starting the engine. Fuel expands from heat and when left under direct sunlight.

Never fill the fuel tank up to the brim. Tighten the filler cap securely after each refuelling.

Avoid contact with skin. Do not inhale vapours. Do not swallow fuel. Do not transfer fuel between different containers using a hose.

DO NOT DISPOSE OF FUEL IN THE ENVIRONMENT.

KEEP AWAY FROM CHILDREN.

Use only premium grade unleaded petrol, min. O.N. 95 (RON) and 85 (MON).

LUBRICANTS

**DANGER**

A good lubrication ensures the vehicle safety.

Failure to keep the lubricants at the recommended level or the use of a non-suitable new and clean type of lubricant can lead to the engine or gearbox seizure, thus causing serious accidents, personal injury or even death.

Gear fluid may cause serious damage to the skin if handled daily and for long periods.

Wash your hands carefully after use.

Do not dispose of oil in the environment.

Take it to the filling station where you usually buy it or to an oil salvage centre.

**WARNING**

When filling the vehicle with this oil, take care not to spill it out. Immediately clean spilt oil, or it might damage the vehicle paintwork.

In case of contact with oil, the tyres surface will become very slippery, thus becoming a serious danger for your safety.

In case of leaks, do not use the vehicle. Check and trace the cause of leaks and proceed to repair.

ENGINE OIL

**DANGER**

Engine oil may cause serious damage to the skin if handled daily and for long periods.

Wash your hands carefully after use.

Do not dispose of oil in the environment.

Dispose of engine oil through the nearest waste oil reclamation firm or through the supplier.

Wear latex gloves when servicing.

FRONT FORK FLUID

**DANGER**

Front suspension response can be modified to a certain extent by changing damping settings and/or selecting a particular grade of oil. Standard oil viscosity: SAE 20W. Different oil grades can be selected to obtain a particular suspension response (choose SAE 5W for a softer suspension, 20W for a stiffer suspension).

The two grades can also be mixed in varying solutions to obtain the desired response.

BRAKE FLUID

NOTE This vehicle is fitted with front and rear disc brakes. Each braking system is operated by an independent hydraulic circuit. The information provided below applies to both braking systems.

**DANGER**

Do not use the vehicle in case brakes are worn out or do not work properly. The brakes are the parts that most ensure your safety and for this reason they must always be perfectly working. Failure to comply with these recommendations will probably lead to a crash or an accident, with a consequent risk of personal injury or death.

A wet surface reduces brakes efficiency.

**DANGER**

In case of wet ground the braking distance will be doubled, since both brakes and tyre grip on the road surface are extremely reduced by the water present on the road surface.

Any water on brakes, after washing the vehicle or driving on a wet road surface or crossing puddles or gips, can wet brakes so as to greatly reduce their efficiency.

Failure to comply with these recommendations may lead to serious accidents, with a consequent risk of severe personal injuries or death.

Brakes are critical safety components. Do not ride the vehicle in case brakes are not working at their best.

Check for brakes proper operation before every trip.

Brake fluid is an irritant. Avoid contact with eyes or skin.

In the event of accidental contact, wash affected body parts thoroughly. In the event of accidental contact with eyes, contact an eye specialist or seek medical advice.

DO NOT RELEASE BRAKE FLUID INTO THE ENVIRONMENT.

KEEP AWAY FROM CHILDREN.

When handling brake fluid, take care not to spill it onto plastic or paint-finished parts or they will damage.

**DANGER**

Do not use any brake fluids other than the specified type. Never mix different types of fluids to top up level, as this will damage the braking system.

Do not use brake fluid from containers which have been kept open or in storage for long periods.

Any sudden changes in play or hardness in the brake levers are warning signs of problems with the hydraulic circuits.

Ensure that the brake discs and brake linings have not become contaminated with oil or grease. This is particularly important after servicing or inspections.

Make sure the brake lines are not twisted or worn.

Prevent accidental entering of water or dust into the circuit.

Wear latex gloves when servicing the hydraulic circuit.

DISC BRAKES**DANGER**

The brakes are the parts that most ensure your safety and for this reason they must always be perfectly working; check them before every trip.

A dirty disc soils the pads.

Dirty pads must be replaced, while dirty discs must be cleaned with a high-quality degreaser.

Perform the maintenance operations with half the indicated frequency if the vehicle is used in rainy or dusty areas, on uneven surfaces or for racing.

Check brake pads for wear.

When the brake pads wear out, the level of the fluid decreases to automatically compensate for their wear.

The front brake fluid reservoir is located on the right handlebar, near the front brake lever.

The rear brake fluid reservoir is located under the right fairing.

Do not use the vehicle if the braking system leaks fluid.

COOLANT

**DANGER**

Coolant is toxic when ingested, contact with eyes or skin may cause irritation. In the event of contact with your skin or eyes, rinse repeatedly with abundant water and seek medical advice. In the event of ingestion, induce vomiting, rinse mouth and throat with abundant water and seek medical advice immediately.
DO NOT RELEASE INTO THE ENVIRONMENT.
KEEP AWAY FROM CHILDREN.

**DANGER**

Take care not to spill coolant onto hot engine parts. It may ignite and produce invisible flames. Wear latex gloves when servicing.
Do not ride when coolant is below the minimum level.

Coolant mixture is a 50% solution of water and antifreeze. This is the ideal solution for most operating temperatures and provides good corrosion protection.

This solution is also suited to the warm season, as it is less prone to evaporative loss and will reduce the need for top-ups.

In addition, less water evaporation means fewer minerals salts depositing in the radiator, which helps preserve the efficiency of the cooling system.

When the temperature drops below zero degrees centigrade, check the cooling system frequently and add more antifreeze (up to 60% maximum) to the solution, if needed.

Use distilled water in the coolant mixture. Tap water will damage the engine.

Refer to the chart given below and add water with the quantity of antifreeze to obtain a solution with the desired freezing point:

Freezing point °C	Coolant % of volume
-20°C (-4°F)	35
-30°C (-22°F)	45
-40°C (-40°F)	55

NOTE Antifreeze fluids have different specifications. The protection degree is written on the label.

**WARNING**

Use nitrite-free antifreeze and corrosion protectant fluids only, with a protection until at least -35°C (-31°F).

TYRES

**WARNING**

If tyres are excessively inflated, the vehicle will be hard, difficult and uncomfortable to ride. In addition, the roadworthiness, mainly on wet surfaces and during cornering, will be impaired. Flat tyres (insufficient pressure) can slip on the rim and make you lose the control of the vehicle. In this case too, both vehicle roadworthiness, manoeuvrability and brake efficiency will be impaired. Tyres changing, repair, maintenance and balancing must be carried out by specialised technicians using suitable equipment.
 When new, tyres can have a thin slippery protective coating. Drive carefully for the first kilometres (miles).
 Never use rubber treating substances on tyres.
 In particular, avoid contact with fluid fuels, leading to a rapid wear.
 In case of contact with oil or fuel, do not clean but change the tyres.

**DANGER**

Some of the factory-assembled tyres of this vehicle are provided with wear indicators. There are several kinds of wear indicators.
 For more information on how to check the wear, contact your Dealer.
 Visually check if the tyres are worn and in this case have them changed.
 If a tyre deflates while driving, stop immediately.
 Avoid hard brakings or moves and do not close throttles too abruptly.
 Slowly close the throttle grip, move to the edge of the road and use the engine brake to slow down until coming to a halt.
 Failure to comply with these recommendations may lead to accidents, with a consequent risk of personal injuries or death.
 Do not install tyres with air tube on rims for tubeless tyres and vice versa.

1.4. RUNNING-IN

1.4.1. RUNNING-IN

Correct engine running-in is essential to ensuring proper performance and durability.

If possible, drive on hilly roads and/or roads with many bends, so that the engine, the suspensions and the brakes undergo a more effective running-in.

During running-in, change speed.

In this way the components are first "loaded" and then "relieved" and the engine parts can thus cool down.

Even if it is important to stress the engine components during running-in, take care not to exceed.



WARNING

Only after the first 1000 km (621 mi) of running-in is it possible to obtain the best acceleration performance from the vehicle.

Keep to the following indications:

- Do not open the throttle completely if the speed is low, both during and after the running-in.
- **0-500 km (0-310 mi)** During the first 500 km (310 mi), do not exceed the 80% of the maximum allowed speed.
- Avoid driving at constant speed for long distances.
- After the first 1000 km (621 mi), progressively increase the speed until reaching the highest performance levels.



DANGER

After the first 1000 km (621 mi), have the checking operations indicated in the column "After running-in" carried out by an aprilia Authorised Dealer, see REGULAR SERVICE INTERVALS CHART, in order to avoid hurting yourself or other people and/or damaging the vehicle.

GENERAL TECHNICAL INFORMATION 2

SUMMARY

2.1.	TECHNICAL INFORMATION	3
2.1.1.	TECHNICAL DATA	3
2.1.2.	SCHEDULED MAINTENANCE CHART	5
2.1.3.	LUBRICANT CHART	7
2.1.4.	TIGHTENING TORQUE SETTINGS	8
2.1.5.	ARRANGEMENT OF THE MAIN ELEMENTS	13
2.1.6.	INSTRUMENT PANEL OPERATION	15
2.2.	SCHEDULED MAINTENANCE	18
2.2.1.	BRAKING SYSTEM	18
2.2.2.	AIR FILTER	20
2.2.3.	COOLANT	21
2.2.4.	TRANSMISSION FLUID	22
2.2.5.	ENGINE OIL	24

2.1. TECHNICAL INFORMATION

2.1.1. TECHNICAL DATA

DIMENSIONS	
Max. Length	2263 mm (89.1 in.)
Max. Width	790 mm (31.1 in.)
Max. height (headlight fairing included)	1419 mm (55.9 in.)
Seat height	785 mm (30.9 in.)
Wheelbase	1535 mm (60.4 in.)
Minimum ground clearance	215 mm (8.5 in.)
Loadless weight (in running order)	194 kg (427.7 lb)
ENGINE	
Model	M 273 M
Type	Single-cylinder, 4-stroke, 4-valve engine, single OHC controlled by chain on flywheel side
Number of cylinders	1
Total displacement	460 cu.cm (28.071 cu.in.)
Bore/stroke	92 x 69 mm (3.622 x 2.716 in)
Compression ratio	10.5 ± 0.5: 1
Starting	electric
Engine idling rpm	1450 ± 50 rpm
Clutch	automatic, dry centrifugal clutch
Gearbox	automatic
Cooling	Liquid cooling (50% water + 50% coolant), forced circulation with centrifugal pump
Lubricating system	Forced circulation by trochoidal pump (inside the crankcase), oil filter and pressure relief by-pass valve
THROTTLE BODY	
Model	Ø 38 mm (1.50 in) and single injector
Throttle	Ø 39 mm (1.53 in.)
FUEL SYSTEM	
Type	Electronic injection with electric fuel pump
Fuel	Unleaded premium fuel (4 Stars  , min. O.N. 95 (RON) and 85 (MON)
CAPACITY	
Fuel (reserve included)	13.2 litres (23.97 pt)
Fuel reserve	3 litres (5.45 pt)
Engine oil	
- changing engine oil and oil filter	1500 cu.cm (91.535 cu.in.)
- change for engine overhaul	1700 cu.cm (103.74 cu.in.)
Transmission fluid	250 cu.cm (15.256 cu.in.)
Coolant	1.7 litres (3.087 pt) (50% water + 50% antifreeze with ethylene glycol)
Seats	2
Vehicle max. load (rider + luggage)	115 kg (253.5 lb)
Vehicle max. load (rider + passenger + luggage)	190 kg (418.9 lb)
TRANSMISSION SYSTEM	
Converter	automatic, stepless
Primary	V-belt
Secondary	gears
Total engine/wheel ratio	
- short	1/14.083
- long	1/5.406
FRAME	
Type	In high strength steel tubes
Steering head angle	27.5°
Trail	108 mm (4.25 in.)
SUSPENSIONS	
Front	hydraulically operated telescopic fork
Stroke	104 mm (4.09 in.)
Rear	Two double-effect hydraulic shock absorbers with preload adjuster
Stroke	100 mm (3.94 in.)

BRAKES	
Front	Disc - Ø 260 mm (10.236 in) - with hydraulic transmission
Rear	Twin disc - front Ø 260 mm (10.236 in) / rear Ø 240 mm (9.449 in)
WHEEL RIMS	
Type	in light alloy
Front	16" x 3.00"
Rear	14" x 4.5"
TYRES	
Type	tubeless
Front	110/70 -16" 56S tubeless
Rear	150 / 70 - 14" 66S tubeless
STANDARD INFLATION PRESSURE	
Front	220 kPa (2.2 bar)
Rear	220 kPa (2.2 bar)
INFLATION PRESSURE WITH PASSENGER	
Front	220 kPa (2.2 bar)
Rear	230 kPa (2.3 bar)
IGNITION	
Type	C.D.I. / induction type
Spark advance	Variable, managed by control unit
SPARK PLUG	
Standard	CHAMPION RG6YC
As an alternative	NGK - CR7EKB
Spark plug gap	0.7 - 0.8 mm (0.028 - 0.031 in)
ELECTRIC SYSTEM	
Battery	12 V - 14 Ah
Fuses	20 - 15 - 3 A
Generator (with permanent magnet)	14 V – 380 W
BULBS	
Low/high beam	12V - 55 W / 12V - 55 W
Front parking light	12 V – 5 W
Rear/front turn indicators light	12V - 10W (rear)/ 12V - 10W (front)
Tail / brake lights	12V - 5W / 21W
Number plate light	12 V – 5 W
WARNING LIGHTS	
Instrument panel lighting	LED
Turn indicators	LED
Engine oil pressure	LED
Low beam	LED
High beam	LED
Fuel reserve	LED
Coolant high temperature indicator	LED













2.1.2. SCHEDULED MAINTENANCE CHART

Suitable maintenance ensures optimum operating conditions and performance and it is essential for vehicle long life.

EVERY 2 years
Coolant - change
Brake fluid - change
At 1000 km (621 mi)
Safety fastening points - check
Throttle control - adjust
Engine oil filter - change
Electric system and battery - check
Coolant level - check
Brake fluid level - check
Engine oil - change
Brake pads - check for wear
Tire pressure and wear - check
Vehicle and braking system test - road test
Hub oil - change
Idling speed - adjust
Crankcase breather - drain
Steering - check
Injection system tubes sealing - visual check
EVERY 5000 km (3107 mi)
Engine oil - check level/top up
Brake pads - check for wear
At 10000 km (6214 mi), 30000 km (18641 mi), 50000 km (31068 mi) and at 70000 km (43496 mi)
Safety fastening points - check
Spark plug - change
Belt - change
Throttle control - adjust
Air filter - check
Belt comp.air filter - check
Engine oil filter - change
Valve clearance - check
Electric system and battery - check
Coolant level - check
Brake fluid level - check
Engine oil - change
Brake pads - check for wear
Converter rollers/ sliders - change
Tire pressure and wear - check
Vehicle and braking system test - road test
Hub oil - check
Idling speed - adjust
Stand striker roller - change
Suspensions - check
Steering - check
Braking system tubes sealing - visual check
Crankcase breather - drain

At 20000 km (12427 mi), 40000 km (24855 mi), 60000 km (37282 mi) and at 80000 km (49710 mi)
Safety fastening points - check
Driven pulley bush
Spark plug - change
Belt - change
Throttle control - adjust
Air filter - check
Belt comp.air filter - check
Engine oil filter - change
Valve clearance - check
Electric system and battery - check
Coolant level - check
Brake fluid level - check
Engine oil - change
Brake pads - check for wear
Converter rollers/ sliders - change
Tire pressure and wear - check
Vehicle and braking system test - road test
Hub oil - check
Idling speed - adjust
Stand striker roller - change
Crankcase breather - drain
Suspensions - check
Steering - check
Injection system tubes sealing - visual check
Fuel filter - check

2.1.3. LUBRICANT CHART

LUBRICANT	PRODUCT
Engine oil	RECOMMENDED:  4T FORMULA RACING, SAE 5W - 40. As an alternative to recommended fluids, top brand oils meeting or exceeding A.P.I. SJ specifications can be used.
Transmission fluid	RECOMMENDED:  GEAR SYNTH, SAE 75W - 90. As an alternative to recommended fluid, top brand oils meeting or exceeding A.P.I. GL3 specifications can be used.
Fork oil	RECOMMENDED:  FORK 5W or  FORK 20W. When you wish to obtain an intermediate response between those offered by  FORK 5W and  FORK 20W oils, you may mix the different products as follows: SAE 10W =  FORK 5W 67% of volume, +  FORK 20W 33% of volume. SAE 15W =  FORK 5W 33% of volume, +  FORK 20W 67% of volume.
Bearings and other lubrication points	RECOMMENDED:  GREASE SM2. As an alternative to recommended grease, use top brand rolling bearing grease that will resist a temperature range of -30°C (-22°F) + 140°C (284°F), with dropping point 150°C (302°F) - 230°C (446°F), high corrosion protection, good resistance to water and oxidation.
Battery terminals	Use neutral grease or Vaseline.
Brake fluid	RECOMMENDED:  BRAKE 5.1 DOT 5 (compatible DOT 4). NOTE Do not mix different makes or types of oil without having checked bases compatibility. As an alternative to the recommended product, top brand brake fluid meeting or exceeding SAE J1703, NHTSA 116 DOT 4, ISO 4925 specifications for synthetic brake fluid can be used.
Engine coolant	RECOMMENDED:  COOL. As an alternative to the recommended product, top brand brake fluid meeting or exceeding CUNA NC 956-16 specifications for ethylene glycol coolant can be used.

2.1.4. TIGHTENING TORQUE SETTINGS

DESCRIPTION	QUANTITY	SCREW / NUT	TIGHTENING TORQUE SETTINGS (Nm)	NOTES
BRAKING SYSTEM				
Rear brake master cylinder to handlebar fastening	2	TCEI screw M6x25	10	
Throttle control to front brake master cylinder fastening	2	TCEI screw M6x25	10	
RH dimmer switch to brake master cylinder fastening	4	TBEI screw M5x16 TBEI screw M5x25	1	
LH dimmer switch to brake master cylinder fastening	4	TBEI screw M5x16 TBEI screw M5x25	1	
Counterweights fastening	2	TSPEI screw M6x55	10	
Brake force distributor to frame fastening	2	TE screw M6x35	10	
Rear brake calliper to calliper mount fastening	2	TE screw M8x40	25	
Rear brake line to frame fastening	2	TE screw M6x16	10	
Front brake calliper fastening	4	TCEI screw M8x35	25	
ENGINE ASSY				
Wiring plate fastening	1	TE screw M6X12	10	
Converter cover fastening	4	TE screw M6X20	10	
Air box support fastening	1	TE screw M6X25	12	
Starter motor cable fastening	1	Nut M6	5	
Rear brake calliper mount fastening	2	TE screw M8X50	25	
Rear brake disc to hub fastening	5	Nuts M6X1	12	
Muffler plate to engine fastening	2	Nut	50	
Engine to air box intake hose clamp fastening	1	Clamp 24.5X8.6	3	
Air box to rear mudguard fastening	1	TCEI screw M6X50	6	
Air box to rear mudguard fastening	1	TCEI screw M6X30	6	
Air box to engine support fastening	1	Screw M5 X20	3	
EXHAUST SYSTEM ASSY				
Lambda sensor to exhaust manifold fastening	1		45	
Exhaust manifold to engine fastening	2	Nuts	15	
Silencer clamp to exhaust manifold fastening	1		17	
Silencer to plate fastening	1	TE screw M8X30	25	
Silencer clamp lock nut to plate fastening	1	Nut M8	12	
Silencer clamp to plate fastening	1	Screw M8X80	11-13	
Muffler cover fastening	3	TBEI Screw M6X20	12	
ENGINE CONNECTING ROD ASSY				
Con-rod pin to frame fastening on threaded bushing	1	Con-rod pin	10	
Con-rod pin to frame fastening, rh side	1	Nut M12	70	
Con-rod pin to frame lock nut fastening, lh side	1	Nut M22	40-50	
Con-rod pin to engine fastening, lh side	1	Nut M12	100-120	
Linkage to engine fastening	1	Nut M12	70	
Linkage to frame fastening	1	Nut M10	40	

DESCRIPTION	QUANTITY	SCREW / NUT	TIGHTENING TORQUE SETTINGS (Nm)	NOTES
FRONT SUSPENSION				
Fork nut	1	Nut	10	TIGHTEN TO 25 Nm THEN SLACKEN AND TAKE TO 10 Nm
Fork lock nut	1	Nut	38	
Fork hub fastening	1	Screw	10	
Front mudguard fastening	3	TE screw M6x16	10	
HANDLEBAR ASSY				
Handlebar to fork fastening	1	Nut M10	50	
STAND ASSY				
Centre stand to frame fastening	2	Nuts M10	30	
Side stand to frame fastening	1	Nut M10	25	
COOLING SYSTEM ASSY				
Radiator to frame fastening	1	TE screw M6X20	10	
Electric fan support to radiator fastening	1	TE screw M5X12	5	
Pump/radiator hose ties fastening	2	Tie	3	
Radiator cap fastening	1	Cap M14	20	
Electric fan support bracket fastening	2	Nut M6	5	
Head/radiator hose ties fastening	2	Tie	3	
REAR WHEEL ASSY				
Rear wheel to hub fastening	5	TE screw M8x40	35	
Rear wheel fastening	1	Nut	120	
REAR SUSPENSION ASSY				
Rh/Lh shock absorber support fastening	4	Nut M8	25	
Rh/Lh shock absorber fastening	4	Nut M10	40	
TANK ASSY				
Fuel tank to frame fastening	2	TE screw M6X20	10	
Front fuel tank support fastening	2	TE screw M8X16	25	
Rear fuel tank support fastening	2	TE screw M8X16	25	
Fuel lines fastening	1	TBEI screw M5x16	5	
Expansion tank support	1	TCEI screw M5X16	5	
Expansion tank fastening	1	TBEI screw M6X16	5	
FRAME ASSY				
Rh/Lh rider platform connection plate fastening	4	TE screw M6X12	10	
Coil to Lh rider platform connection plate fastening	2	Nut M6	10	
Radiator cowl to frame fastening	2	TBEI screw M6X16	5	
Rear arch to frame fastening	2	TE screw M8X16	25	
Rh/Lh passenger footpegs support fastening	4	TCEI screw M8X25	25	
Rh/Lh passenger footpegs support fastening	2	TCEI screw M8x35	25	

DESCRIPTION	QUANTITY	SCREW / NUT	TIGHTENING TORQUE SETTINGS (Nm)	NOTES
ELECTRIC SYSTEM ASSY				
Linear switch to frame fastening	2	TE screw M5X16	6	
Control unit to frame fastening	3	TE screw M5X16	6	
H.T. coil to coil support bracket fastening	4	TE screw M3X20	2	
Relay support bracket to frame fastening	3	TE screw M5X12	6	
Ground cables to frame fastening	1	TE screw M6x16	10	
Seat lock plate to case fastening	2	TCB screw M4X12	1	
Electric actuator to seat lock plate fastening	2	Nut M4	1	
Return lever to seat lock plate fastening	1	Nut M4	3	
Case light glass to case fastening	1	SELF-TAPPING screw 3.9X14	1	
Seat lock to case fastening	2	TBEI screw M6X16	4	
Voltage regulator bracket to horn fastening	1	TE screw M6x16	10	
Voltage regulator fastening	2	TE screw M6x35	10	
Case light switch to case fastening	1	SELF-TAPPING screw 3.9X14	1	
Starter motor cable to relay fastening	1	Nut M6	5	
Battery cable to starter motor relay fastening	1	Nut M6	5	
Antitheft system control unit to frame fastening	3	SELF-TAPPING screw 3.9X14	1	
Connector closure to antitheft system fastening	2	SELF-TAPPING screw 3.9X10	1	
Odometer sensor fastening	1	Nut M6	10	
REAR CHASSIS ASSY				
Rear mudguard to muffler plate fastening	2	TE screw M6x16	10	
Number plate holder to frame and case fastening	5	TBEI screw M6X16	6	
Rh/Lh tail guard to case fastening	4	SELF-TAPPING screw 5X14	1,5	
Rh/Lh tail guard to Rh/Lh platform fastening	4	SELF-TAPPING screw 3.9X14	1,5	
Tail light mount fastening	4	SELF-TAPPING screw 3.9X14	1,5	
Tail light fastening	2	TCB screw 4.2X20	1	
Luggage rack fastening	2	TE screw M8X25	25	
Luggage rack centre fastening	1	TE screw M8X30	25	
Luggage rack cover fastening	4	SELF-TAPPING screw 3.9X14	0.5	
Rh turn indicator to tail guard fastening	2	SELF-TAPPING screw 3.9X14	1	
Lh turn indicator to tail guard fastening	2	SELF-TAPPING screw 3.9X14	1	
No. plate light mount to no.plate holder fastening	3	TBEI screw M5x16	5	
Number plate light fastening	1	TCB screw 4.2X16	1	

DESCRIPTION	QUANTITY	SCREW / NUT	TIGHTENING TORQUE SETTINGS (Nm)	NOTES
CENTRE CHASSIS ASSY				
Case to frame fastening	6	TBEI screw M6X16	8	
Rh/Lh platform to Rh/Lh rider platform connection plate fastening	4	TBEI screw M5X12	4	
Rh/Lh platform to radiator cowl fastening	3	TBEI screw M5x16	2	
Inner shield to side shield halves and tunnel fastening	5	TCB screw 5.55X22	3	
Bag hook fastening	2	TCB screw 4.2X25	1	
Seat hinge to seat fastening	4	Nut M6	5	
Spark plug seat cover fastening	2	TCB screw 5.5X15.9	2	
Spark plug seat cover fastening	1	TCB screw 4.2X16	1	
Rh/Lh multipurpose net to shield fastening	4	SELF-TAPPING screw 3.9X14	1	
Glove compartment door frame to door fastening	4	Screw 3.9X10	1,5	
Plate to glove compartment door fastening	2	Screw 3.9X10	1,5	
Plate to fuel filler flap fastening	1	SELF-TAPPING screw 3.9X14	1	
Glove compartment door to shield fastening	4	SELF-TAPPING screw 3.9X14	1	
Fuel filler flap to tunnel fastening	2	SELF-TAPPING screw 3.9X14	1,5	
FRONT CHASSIS ASSY				
Air breather grid to rh shield half fastening	3	SELF-TAPPING screw 3.9X14	1	
Air breather grid to lh shield half fastening	3	SELF-TAPPING screw 3.9X14	1	
Shield half to rh radiator cowl fastening	3	TCB screw 4.2X16	1	
Shield half to lh radiator cowl fastening	3	TCB screw 4.2X16	1	
Tunnel fastening	4	TCB screw 5.55X22	2	
Front mudguard fastening	4	TE screw M6x16	10	

DESCRIPTION	QUANTITY	SCREW / NUT	TIGHTENING TORQUE SETTINGS (Nm)	NOTES
FRONT CHASSIS ASSY				
Logo to cover fastening	4	SELF-TAPPING screw 3.9X14	1	
Ignition switch cover to shield fastening	6	Washers for shafts	\	
Rh/Lh turn indicator to cover fastening	4	TCB screw M4X12	1,5	
Rh leg guard fastening	1	TCB screw 4.2X16	1	
Rh leg guard fastening	1	TBEI screw M5x16	2	
Lh leg guard fastening	1	TBEI screw M5x16	2	
Lh leg guard fastening	1	TCB screw 4.2X16	1	
Rh/Lh turn indicators to shield halves fastening	2	Screw 3.9X10	0,5	
Cover fastening	2	TCB screw 4.2X16	1	
Inner shield to frame fastening	2	TBEI screw M5X12	2	
Radiator cowl to frame fastening	2	TBEI screw M6X16	8	
Radiator cowl to frame fastening	1	TBEI screw M6X16	4	
Rh/Lh turn indicator cover fastening	4+4	Washers	\	
Cover fastening	2	TCB screw 5.5X15.9	2	
LOCKS				
Lock lever pin to frame fastening	1	Nut M4	3	
Fuel tank flap lock fastening	2	TBEI screw M5x16	2	
Dog to Tunnel fastening	2	SELF-TAPPING screw 3.9X14	1	
HEAD INSTRUMENT PANEL ASSY				
Headlight to handlebar fastening	2	TBEI screw M5x16	3	
Headlight plate to instrument panel plate fastening	4	TCB screw M4X16	1,5	
Instrument panel to plate fastening	2	SELF-TAPPING screw 3.9X10	1	
Headlight ring nut fastening	1	SELF-TAPPING screw 5X14	1	
Instrument panel plate to handlebar fastening	2	SELF-TAPPING screw 5X14	1,5	
Instrument panel to ring nut fastening	4	SELF-TAPPING screw 3.9X14	1	
FRONT WHEEL ASSY				
Wheel shaft fastening	1		50	

2.1.5. ARRANGEMENT OF THE MAIN ELEMENTS

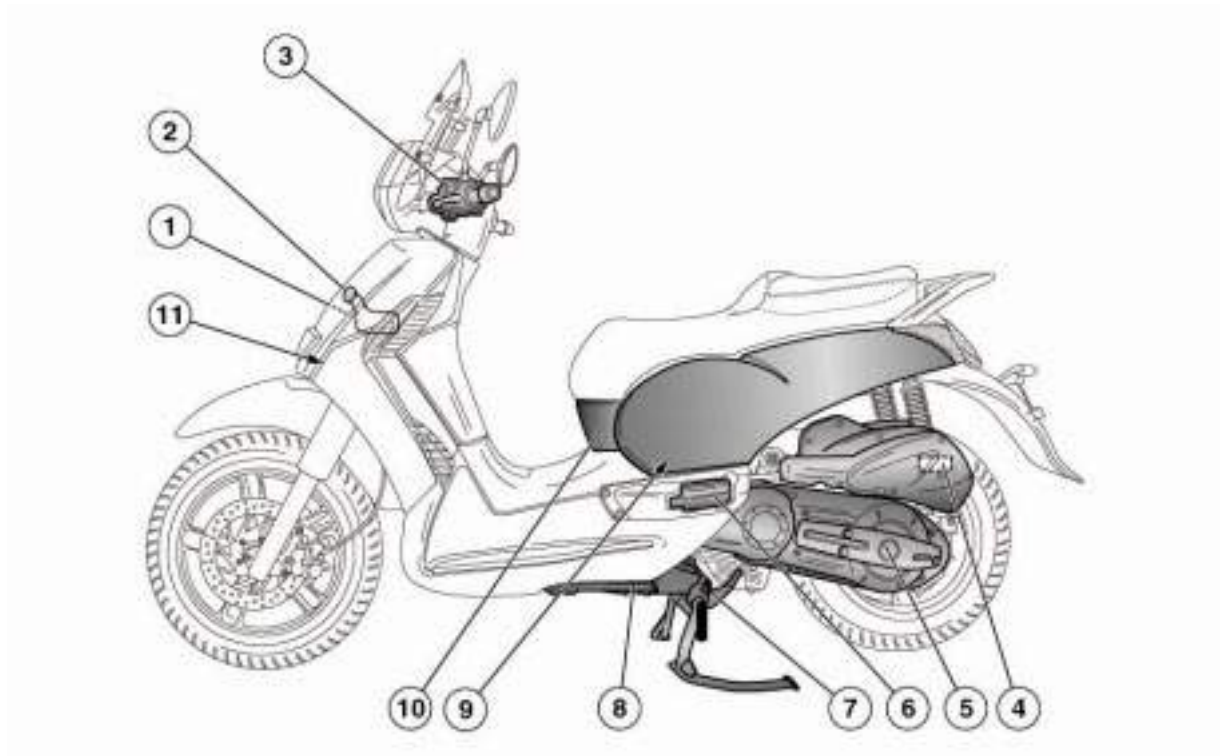

Key:

1. Expansion tank
2. Coolant expansion tank cap
3. Integrated brake fluid reservoir
4. Air filter
5. Transmission cover
6. Left passenger footpeg
7. Centre stand
8. Side stand
9. Spark plug
10. Central inspection cover
11. Warning horn

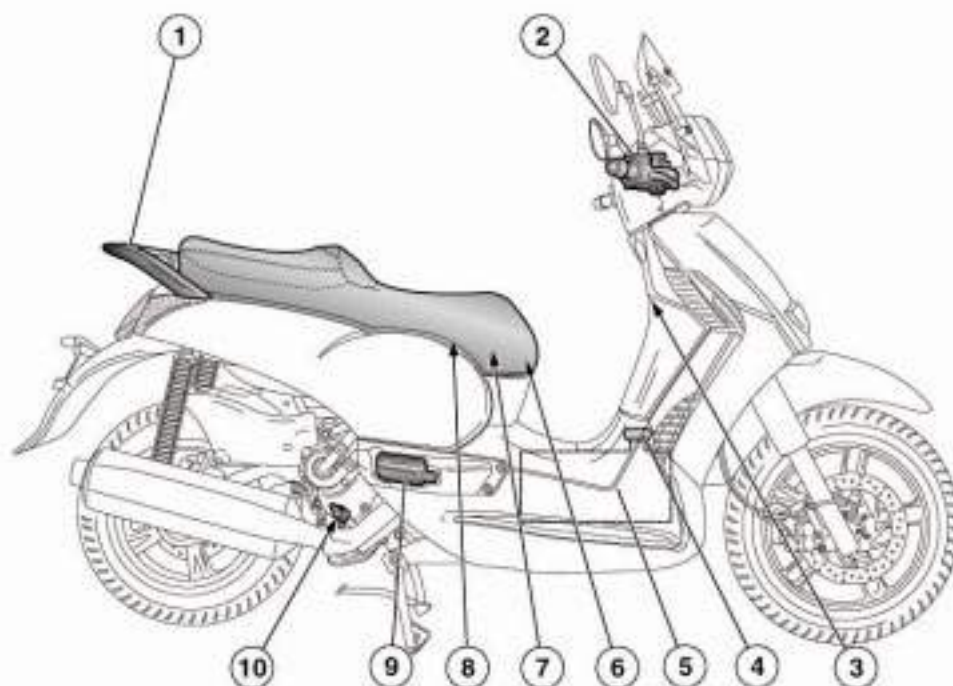

Key:

1. Passenger grab handle
2. Front brake fluid reservoir
3. Seat release lever
4. Fuel tank filler plug
5. Fuel tank
6. Battery
7. Auxiliary fuse carrier
8. Main fuse carrier
9. Right passenger footpeg
10. Engine oil level / filler plug

2.1.6. INSTRUMENT PANEL OPERATION

Turn the ignition key to , on the multifunction LCD all segments activate (in this way a check routine of the components is performed) and the last function set before vehicle stopped is displayed.

NOTE The Service icon on the LCD turns on after the first 1000 km (621 mi) and then every 10000 km (6214 mi). When set Service mileage is 300 km (186 mi) away, the Service icon starts blinking after the check routine performed at start-up and blinks for about 5 seconds. As soon as set mileage is reached, the icon stays on permanent until the vehicle is Serviced.

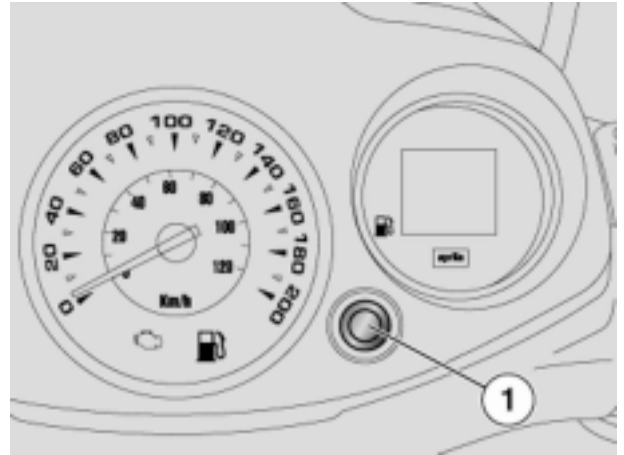

The various functions are selected and then displayed pressing the (MODE) button (1) located among the controls on the left side of handlebar. Segments of the multifunction LCD are:

- digital clock (3),
- odometer indicator (4),
- unit of measurement expressed in km (5),
- unit of measurement indicator expressed in miles (6),
- trip meter indicator (7),
- service warning indicator (8),
- fuel level indicator (9)

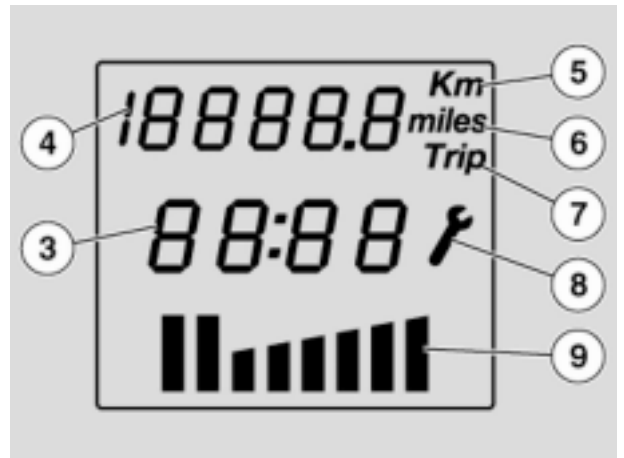

The diagram shows the sequence of available functions:

Pulse means pressing the key and holding it for a certain time between 0.5 sec and 3 sec.

STARTING STATE

When key is turned on, the instrument panel shows the last selected quantity.

SETTING THE TIME

From the odometer function, hold the MODE button for more than 3 seconds to enter time setting mode.

For safety reasons, this should be performed with vehicle stopped, i.e. when vehicle speed equals zero.

When entering the hour setting mode, the display will switch off two digits; the other two are the ones being set and will increase on each pulse of the MODE button.

Press again the button for more than 3 seconds to enter minute setting mode, in this case the two digits for hours are switched off and the remaining two will increase on each pulse of the MODE button.

If you press the button for more than 3 seconds, display goes back to hour setting mode.

If no key is disturbed for 3 seconds, the display automatically goes back to the state set before entering setting mode. The marks dividing hours and minutes will flash when in setting mode.

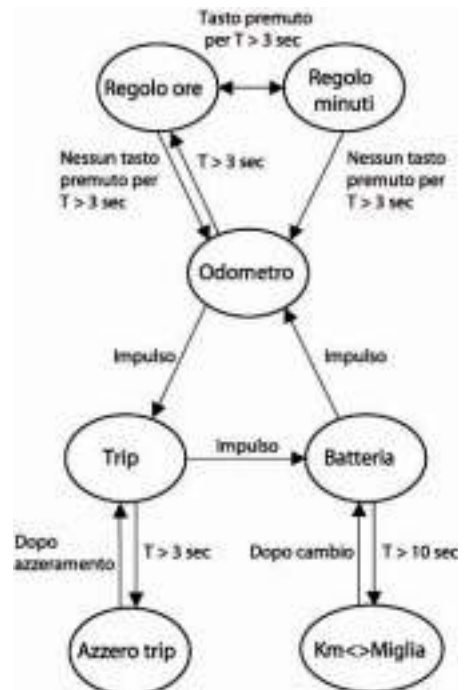

TRIP METER RESET

From the trip meter function, hold the MODE button for more than 3 seconds to reset it.

SELECTING KM OR MILES

From the battery function, hold the MODE button for more than 10 seconds to toggle between Km and miles reading both for odometer and tachometer (if on the display).

While button is being pressed, indication of current unit of measurement (Km or Miles) will flash with a frequency of 1Hz.

If button is released before 10 seconds have elapsed, unit of measurement is not changed.

More functions

SOFTWARE VERSION

Software version is displayed when battery is activated.

SERVICE

When the vehicle is started, just after ignition check routine, the Service icon will flash for 5 seconds if the following scheduled Service is less than 300 Km (200 Miles) away.

As soon as the vehicle reaches set Service mileage, the Service icon is fixed on until it is reset.

SERVICE RESET

The service icon is reset by holding the MODE button for more than 10 seconds when the key is turned on: the instrument panel will not show any warning for the first 5 seconds, then the Service icon will flash with a frequency of 1Hz during the next 5 seconds.

ODOMETER RESET

In order to allow end of line inspections, it should be possible to reset the odometer (only once) within the first 200Km (124 mi) of mileage.

Resetting procedure is the same as Service reset.

If odometer is reset during the end of line inspections, even the service counter should be reset, so that it will first come on when odometer indicates 1000km (621 mi).

TRIP METER RESET

- Hold down the Mode button (1) for at least three seconds.

NOTE The displayed function will be displayed.

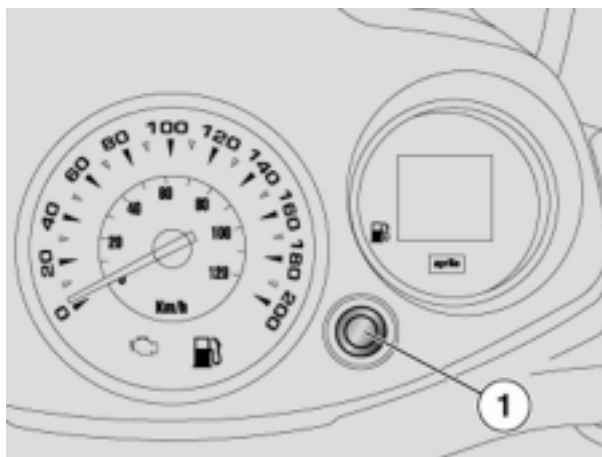
**DIGITAL ODOMETER**

The segments making up the odometer function in the LCD are:

- Trip meter icon (5)
- Six-digit indication (2)
- Unit of measurement expressed in km (3)
- Unit of measurement expressed in miles (4)

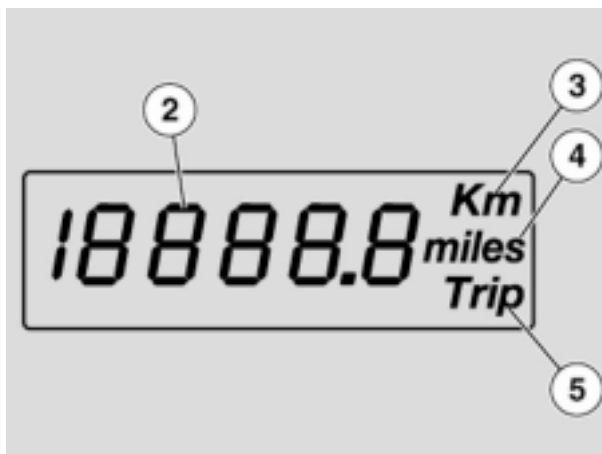

Press the MODE button a few times to enter the "TRIP" mode

SCARABEO 500

TRIP RESET TRIP 1/TRIP 2

- Press and hold (MODE) button (1) for more than three seconds when selected TRIP meter is displayed.

NOTE The displayed function will be reset.

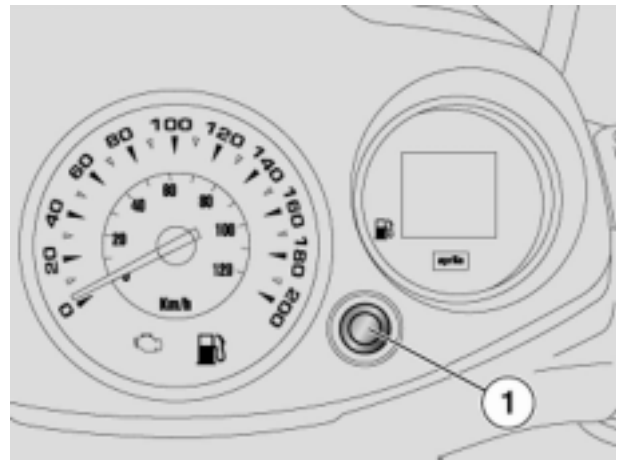

The warning lights should be visible even when under direct sunlight.

TURN INDICATORS

This light should use a green LED that turns on at the same time as the turn indicators.

FUEL RESERVE

This light should use an orange LED that turns on when the vehicle is using the fuel reserve.

OIL ALARM

This light should use a red LED that indicates oil pressure alarm.

HIGH BEAM

This light should use a blue LED and should turn on when the high beam is on.

EFI

This light should use a red LED and indicates failures of the engine control unit.

EXTERNAL ANTITHEFT SYSTEM

This light should use a red LED and is piloted by a possible external antitheft system (i.e. it is not managed by the microprocessor)

2.2. SCHEDULED MAINTENANCE

2.2.1. BRAKING SYSTEM



DANGER

It is fundamental that air is bled off the hydraulic circuit after the brakes have been refitted and the braking system has been restored to its standard operating conditions, since it would be very dangerous for the vehicle and the rider not to do so.

NOTE This vehicle is equipped with a braking system consisting of:

- two disc brakes at the front;
- one disc brake at the rear;
- a delay valve under the headlight.

Action on the right (front) brake lever causes pressure on the front left brake calliper.

Action on the left (rear) brake lever causes, through the delay valve, a pressure on the front right brake calliper and on the rear brake calliper.

BLEEDING THE FRONT BRAKE

NOTE The following procedure applies to both front brake callipers.

- Remove the rubber protection cap from bleed valve (1).
- Slide a clear plastic tube onto front calliper bleed valve (1) and set the other end of the tube in a collector tank.
- Pull and quickly release the brake lever of the relevant calliper a few times, then keep it pulled.



- Loosen the bleed valve (1) by 1/4 of a turn so as the brake fluid flows in the container, this will remove any tension from the lever and help it travel fully home.
- Repeat process until the fluid draining into the container is totally clear of air bubbles.

NOTE While bleeding the hydraulic circuit, top up reservoir with brake fluid as required. Make sure there is always some fluid in the reservoir throughout the process.

- Tighten the bleed valve (1) and remove the tube.
- Top up to restore correct level inside front brake fluid reservoir.
- Refit the rubber cap.

BLEEDING THE REAR BRAKE

- Remove the rubber protection cap from bleed valve (2).
- Slide a clear plastic tube onto rear calliper bleed valve (2) and set the other end of the tube in a collector tank.
- Pull and quickly release the rear brake lever a few times, then keep it pulled.
- Loosen the bleed valve by 1/4 of a turn so as the brake fluid flows in the container, this will remove any tension from the lever and help it travel fully home.
- Repeat process until the fluid draining into the container is totally clear of air bubbles.

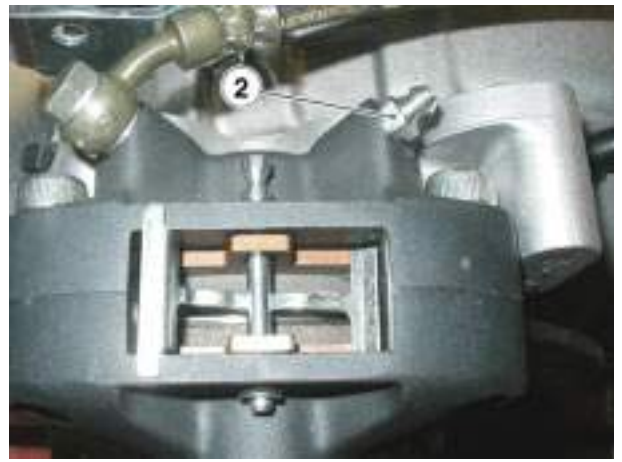

NOTE While bleeding the hydraulic circuit, top up reservoir with brake fluid as required. Make sure there is always some fluid in the reservoir throughout the process.

- Tighten the bleed valve (2) and remove the tube.
- Top up to restore correct level inside rear brake fluid reservoir.
- Refit the rubber cap.

BLEEDING THE BRAKE FORCE DISTRIBUTION

NOTE If the rear brake lever still feels "spongy" after bleeding the front and rear braking systems or in case the brake force distributor is replaced, proceed as follows:

- Remove the front cover, see (REMOVING THE FRONT COVER).
- Remove the rubber protection cap from bleed valve (3).
- Slide a clear plastic tube onto bleed valve (3) and set the other end of the tube in a collector tank.
- Pull and quickly release the rear brake lever a few times, then keep it pulled.



- Loosen the bleed valve (3) by 1/4 of a turn so as the brake fluid flows in the container, this will remove any tension from the lever and help it travel fully home.
- Repeat process until the fluid draining into the container is totally clear of air bubbles.

NOTE While bleeding the hydraulic circuit, top up rear brake reservoir with brake fluid as required. Make sure there is always some fluid in the reservoir throughout the process.

- Tighten the bleed valve (3) and remove the tube.
- Top up to restore correct level inside rear brake fluid reservoir.
- Refit the rubber cap.

2.2.2. AIR FILTER

To clean the filtering element it is necessary to remove it from the vehicle.

REMOVAL

- Position the vehicle on the centre stand.
- Unscrew and remove the nine screws (1).



- Remove the air box cover complete with filter.
- Check the filtering element and change it if required.

CLEANING



WARNING

Do not use petrol or inflammable solvents to wash the filtering element, in order to avoid fires or explosions.

Use compressed air only.

Blow the filtering element with compressed air. **NEVER SMEAR THE FILTERING ELEMENT WITH OIL.** Any oil seeping into the belt casing would damage the belt and cause it to slip.



2.2.3. COOLANT

CHECKING AND TOPPING UP

**WARNING**

Wait for the engine to cool down before checking or topping up coolant level.

- Stop the engine and wait until it has cooled down.

NOTE Position the vehicle on firm and flat ground.

- Remove the front cover, see (REMOVING THE FRONT COVER).
- Ensure that fluid level inside expansion tank (2) is between “**MIN**” and “**MAX**” notches.

MIN = minimum level.

MAX = maximum level.

If not so:

- Loosen the filler plug (1) (by turning it anticlockwise), without removing it.
- Wait a few seconds in order to release any residual pressure.
- Unscrew and remove the plug (1).

**WARNING**

Do not add additives or other substances to the fluid.

- Top up with coolant, see (LUBRICANT CHART), until level reaches approximately “**MAX**” mark.
- Level should not exceed this mark, or fluid will leak out during engine operation.
- Put back the filling cap (1).

**WARNING**

If coolant level drops too quickly or the expansion tank is empty, check the cooling circuit for leaks.

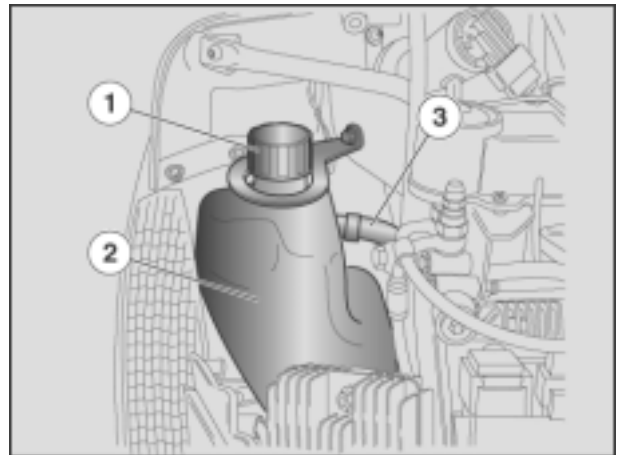

2.2.4. TRANSMISSION FLUID

NOTE Only use recommended oil, see (LUBRICANT CHART)

- Ride for a few kilometres to warm up engine to operating temperature then stop the engine.

CHECK

- Position the vehicle on firm and flat ground.
- Position the vehicle on the centre stand.



WARNING

Allow several minutes for the engine and exhaust system to cool down.

- Unscrew and extract the plug/dipstick (1).
 - Clean the part in contact with the oil with a clean cloth.
 - Tighten the plug/dipstick (1) completely, screwing it into the filling hole.
 - Withdraw the plug/dipstick (1) again and read the oil level on the dipstick itself.
- Level is correct when it reaches approximately the first notch above the spot.
 - If necessary, provide for topping up.

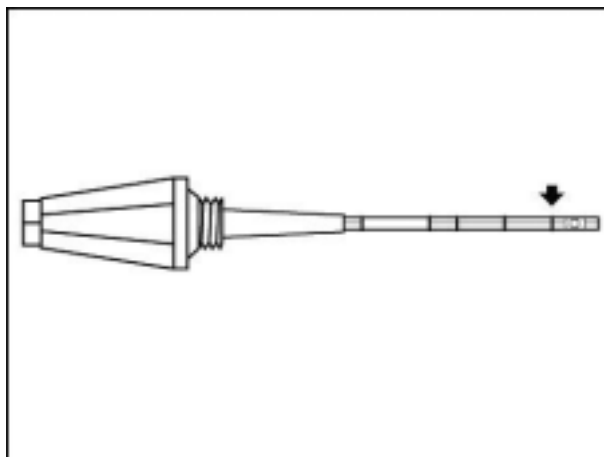

TOPPING UP

- Pour a small quantity of oil in the filling hole and wait about one minute, so that the oil flows into the oil pan.
- Check the oil level and top up if necessary.
- Top up by adding small quantities of oil, until reaching the prescribed level.
- At the end of the operation, screw and tighten the plug-dipstick (1).

NOTE Do not use the vehicle with insufficient lubrication or with contaminated or unsuitable lubricants, since this would cause early wear of the moving parts and may also cause irreparable failures.

SCARABEO 500

CHANGE

- Position the vehicle on firm and flat ground.
- Position the vehicle on the centre stand.

**WARNING**

Allow several minutes for the engine and exhaust system to cool down.

- Unscrew and extract the plug/dipstick (1).
- Set a collector tank with a capacity of more than 300 cu.cm (18.3 cu.in) under drain screw (2).
- Loosen and remove the drain screw.
- After draining all transmission fluid, tighten the drain screw (2).
- Pour about 250 cu.cm (15.2 cu.in) of transmission fluid into the filler opening.
- Screw and tighten the plug/dipstick (1).
- Start the engine and let it run for several minutes. Stop the engine and let it cool down.
- Check again transmission fluid level.

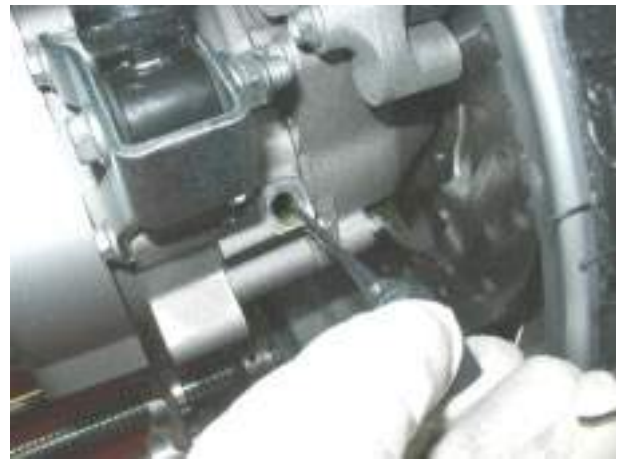

2.2.5. ENGINE OIL

CHECKING AND TOPPING UP

NOTE Only use recommended oil, see (LUBRICANT CHART)

When topping up the engine oil, never exceed the "MAX" level.

CHECK

- Position the vehicle on firm and flat ground.
- Position the vehicle on the centre stand.



WARNING

Allow several minutes for the engine and exhaust system to cool down.

Stop the engine and let it cool down, in order to allow the oil to flow into the oil pan and to cool down.

NOTE Failure to perform the operations described above may result in the incorrect measurement of the engine oil level.

- Unscrew and extract the plug/dipstick (1).
- Clean the part in contact with the oil with a clean cloth.
- Tighten the plug/dipstick (1) completely, screwing it into the filling hole (2).
- Withdraw the plug/dipstick (1) again and read the oil level on the dipstick itself:

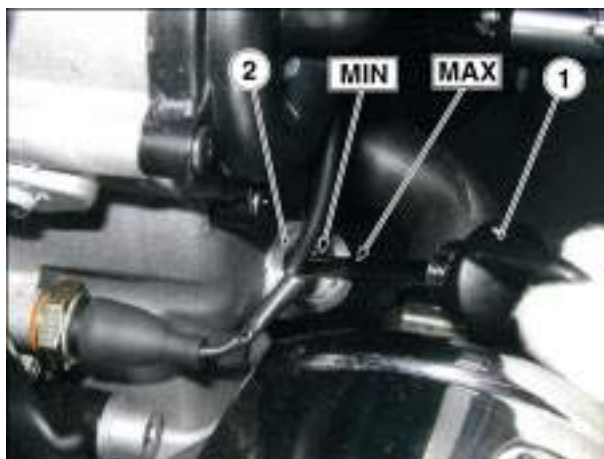

MAX = maximum level;

MIN = minimum level.

- The level is correct if the oil reaches approx. the "MAX" mark on the dipstick.



DANGER

Never exceed the "MAX" mark or let oil level drop below the "MIN" mark, as this may lead to severe engine damage.

- If necessary, provide for topping up.

TOPPING UP

- Pour a small quantity of oil in the filling hole (2) and wait about one minute, so that the oil flows into the oil pan.
- Check the oil level and top up if necessary.
- Top up by adding small quantities of oil, until reaching the prescribed level.
- At the end of the operation, screw and tighten the plug/dipstick (1).

NOTE Do not use the vehicle with insufficient lubrication or with contaminated or unsuitable lubricants, since this would cause early wear of the moving parts and may also cause irreparable failures.

SCARABEO 500

CHANGING ENGINE OIL AND OIL FILTER

NOTE Position the vehicle on firm and flat ground.

- Position the vehicle on the centre stand.

**WARNING**

Allow several minutes for the engine and exhaust system to cool down.

- Stop the engine and let it cool down, in order to allow the oil to flow into the oil pan and to cool down.

- Unscrew and extract the plug/dipstick (1).
- Set a container under engine oil filter.



- Unscrew and remove the oil cartridge filter.

**WARNING**

Used oil contains substances that are very dangerous for the environment. Dispose of used oil in accordance with applicable regulations.

- Unscrew and remove the oil drain plug (3) and let all engine oil flow inside the container.
- Install a new oil cartridge filter. Lubricate the filter O-rings with oil before installation.
- Screw and tighten the engine oil drain plug (3).



- Pour about 1700 cu.cm (103.7 cu.in) of engine oil into the filler opening.
- Screw and tighten the plug/dipstick (1).
- Start the engine and let it run for several minutes. Stop the engine and let it cool down.
- Check again engine oil level.



FUEL SYSTEM

3

SUMMARY

3.1. FUEL TANK..... 3
3.1.1. FUEL SUPPLY SYSTEM DIAGRAM..... 3
3.1.2. REMOVING THE TANK..... 4
3.2. AIR FILTER..... 6
3.2.1. REMOVING THE AIR BOX..... 6
3.3. DIAGNOSIS..... 8
3.3.1. AXONE..... 8

3.1. FUEL TANK

3.1.1. FUEL SUPPLY SYSTEM DIAGRAM

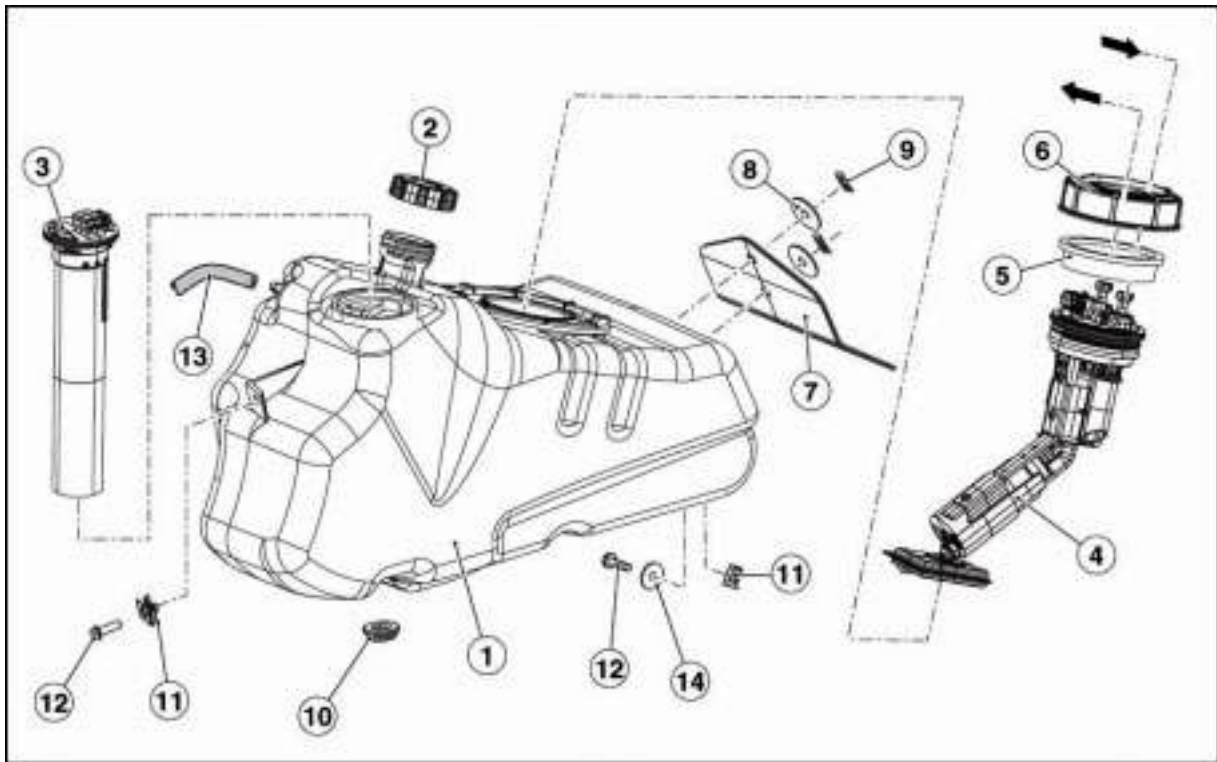

Key:

1. Fuel tank
2. Tank plug
3. Fuel level sensor
4. Fuel pump
5. Fuel pump ring nut seal
6. Fuel pump ring nut
7. Heat shield
8. Washer
9. Plate
10. Rubber block
11. Clip M6
12. Flanged Hex.screw M6X20
13. Fuel line D5.5X10
14. Washer 6.6X18X1.6

3.1.2. REMOVING THE TANK

- Remove the front cover, see (REMOVING THE FRONT COVER).
- Remove the tail guard, see (REMOVING THE TAIL GUARD)
- Remove the footboard (REMOVING THE FOOTBOARD)
- Remove the leg guards, see (REMOVING THE FORK LEGS)
- Remove the front mudguard by loosening the four inner retaining screws.
- Loosen and remove the two spoiler front screws.



- Disconnect electric connection and fuel delivery and inlet lines.



- Working on the left side, disconnect the electric connector; working on the right side, slide off the hose.



- Move the spoiler toward the mudguard so to gain access to tank bottom and front ends.
- Working on either side, loosen and remove the screw securing the rear lower support crosspiece.
- Remove the crosspiece.



SCARABEO 500

- Working on either side, loosen and remove the two screws securing the front lower support crosspiece.
- Remove the crosspiece.



- Loosen and remove the tank front retaining screw.



- Loosen and remove the tank rear retaining screw.
- Detach the tank from the frame and remove it.



3.2. AIR FILTER

3.2.1. REMOVING THE AIR BOX

- Working on the left side, loosen and remove the two side securing screws from rear mudguard and collect both washers.

NOTE On refitting, pay special attention to the length of the securing screws as the rear screw is shorter.



- Loosen and remove the securing screw from the oil recovery flange.



- Slide the flange out of its seat.



- Loosen the screw of the air filter inner support.



- Loosen the intake manifold clamp.
- Remove the bleeder.









- Remove the air box.



3.3. DIAGNOSIS

3.3.1. AXONE

SYMBOL	SCREEN
	ISO
	ENGINE PARAMETER READING
	DEVICE STATUS (in general they are "On – Off" values)
	DEVICES ACTIVATION
	ERRORS DISPLAY
	ADJUSTABLE PARAMETERS
	FREEZE FRAME

SCREEN	DESCRIPTION	APPROXIMATE VALUES	UNIT OF MEASURE	NOTES
ISO				
	Aprilia hardware	XXXXXX000	-	Mapping code with reversed figures. If all figures are nought, it means that the ECU is empty (not mapped): it is necessary to upload the suitable mapping (see note concerning mapping parameter)
	Aprilia software		-	Meaningless field
	Revision number	XX	-	
	Engine	500 cc	-	Single-cylinder engine, 500cc
	Manufactured on	dd/mm/yy	-	ECU date of manufacture
	Mapping	XXXXXX	-	Mapping code stored in ECU.
	Programming date	dd/mm/yy	-	Date last mapping was loaded: day/month/year
	Last programmer	XXXXX	-	ID code for the PC or Axone tester that loaded the latest mapping. In this 5.0.2 version, the code shown is not correct: to see it correctly, go to ISO page that appears when selecting REPROGRAM

SCREEN	DESCRIPTION	APPROXIMATE VALUES	UNIT OF MEASURE	NOTES
ENGINE PARAMETER READING				
	Water temperature	-	°C	Measured with sensor on engine
	Air temperature	-	°C	Temperature measured at engine intake (sensor in throttle housing). Note that the temperature at the instrument panel is measured by a different sensor
	Engine rpm	-	rpm	Measured with crankshaft speed sensor
	Target idle rpm	1700	rpm	The ECU attempts to bring the engine to this target speed (depending on engine temperature).
	Ignition advance	-	°	Ignition advance relative to TDC
	Trimmer TPS			
	Idle motor	50	Steps	Stepper (idle) motor position, example value measured with warm engine
	Battery voltage	-	V	Voltage measured at battery terminals
	Engine phase number within which more than a tooth was missed since the beginning of the trip	0/1		1 if many teeth are missing
	Engine phase number within which just a tooth was missed since the beginning of the trip	0/1		1 if one tooth is missing
	Actual to target steps difference		Steps	Difference between target and actual steps of the stepper motor
	Lambda correction	1	-	The value must vary around 1 when the ECU uses the oxygen sensor signal to keep combustion close to the stoichiometric value
	Lambda sensor	100-900	mV	Voltage of the signal of the Lambda sensor: this is a fixed value when the circuit is interrupted
	Injection time	-	ms	Injector activation time
	Atmospheric pressure	760	mmHg	Atmospheric pressure of air (for mapping)
	Partial load self-adaptation		mg/cc	Parameter for self-adjustment of lambda sensor when under partial load
	Idle control self-adaptation		mg/cc	Parameter for self-adjustment of lambda sensor at idle speed
	Gain control adaptation		%	Parameter for self-adjustment of lambda sensor at full load

SCREEN	DESCRIPTION	APPROXIMATE VALUES	UNIT OF MEASURE	NOTES
DEVICE STATUS				
	Engine status	OFF / rotating	-	Engine stationary or in rotation
	Signal panel	Synchronized/Not sync	-	Synchronized if the ECU detects correct synchronisation (by way of crankshaft speed sensor)
	Idle/full load	on/off		ON when engine is idling
	Lambda sensor ON	on/off		ON if the ECU is using the lambda sensor signal to maintain stoichiometric combustion
ADJUSTABLE PARAMETERS				
	Throttle position self-learning			Simply press the enter button to save the closed throttle position in memory
	Self-adaptive parameter reset			Reset self-adjusting lambda sensor parameters (in the event of installation of a new engine, a new lambda sensor or a new injector)
	Error clearing			Press "enter" to transfer errors from the memory (MEM) to the historical record (STO). The next time Axone is connected to the ECU, the errors in the historical record (STO) will no longer be displayed
	Fuel pump			The device is activated: in the event that the device is not activated successfully this will be immediately indicated in the Axone screen
	Coil			The device is activated: in the event that the device is not activated successfully this will be immediately indicated in the Axone screen
	Revolution counter			The device is activated: in the event that the device is not activated successfully this will be immediately indicated in the Axone screen
	Injectors			The device is activated: in the event that the device is not activated successfully this will be immediately indicated in the Axone screen
	Electric fan			The device is activated: in the event that the device is not activated successfully this will be immediately indicated in the Axone screen
	Stepper motor			The device is activated: in the event that the device is not activated successfully this will be immediately indicated in the Axone screen

SCREEN	DESCRIPTION	APPROXIMATE VALUES	UNIT OF SIZE	NOTES
ERRORS DISPLAY				
	Throttle	-	-	In the event of an interruption in the throttle position sensor signal
	Pressure	-	-	In the event of an interruption in the atmospheric pressure sensor signal
	Lambda sensor	-	-	Appears if the sensor signal circuit is interrupted
	Water temperature	-	-	Open in the sensor, the circuit or the relative connectors
	Air temperature (°C):	-	-	Open in the sensor, the circuit or the relative connectors
	Battery voltage	-	-	
	Injector	-	-	Open in the sensor, the circuit or the relative connectors
	Coil	-	-	Open in the sensor, the circuit or the relative connectors
	Idle motor	-	-	Open in the sensor, the circuit or the relative connectors
	Fuel pump relay	-	-	
	Electric fan	-	-	Open in the sensor, the circuit or the relative connectors
	Self-adaptive parameters			
	RAM memory			ECU internal error
	ROM memory			ECU internal error
	EEPROM			ECU internal error
	Microprocessor			ECU internal error
	Signal panel	-	-	If the crankshaft speed sensor is disconnected this error will not be displayed

From the Adjustable parameters page, it is possible to:

- reset the throttle position sensor,
- initialise the ECU, i.e. reset the throttle position sensor, reset the stepper (idle) motor and reset the self-adaptive parameters for lambda control.
- initialise the ECU, necessary in case a new ECU is installed

Reset the throttle position sensor

Throttle position sensor reset should be performed in case the throttle body and/or the ECU are changed.

- Select: "Throttle position self-learning".
- Ensure that the throttle is fully home
- Press ENTER "  ".
- Turn the key to "OFF" and allow at least 30 seconds.

ECU initialisation

ECU should be initialised in case important engine parts (valves, cylinder, camshaft), exhaust system parts, ECU components, fuel feed system parts, lambda sensor parts are replaced.

The three self-adaptive correction factors for lambda control concerning injection time are electronically reset.

- Select: "initialisation".
- Ensure that the throttle is fully home
- Press ENTER "  ".
- Turn the key to "OFF" and allow at least 30 seconds.

Initialisation allows activation of the new ECU

- Select: "initialise ECU".
- Follow the instructions given to activate the ECU
- Turn the key to "OFF" and allow at least 30 seconds.

ENGINE

4

SUMMARY

4.1. ENGINE..... 3
4.1.1. REMOVING THE ENGINE FROM THE FRAME..... 3
4.1.2. INSTALLING THE ENGINE 17

4.1. ENGINE

4.1.1. REMOVING THE ENGINE FROM THE FRAME

- Position the vehicle on the centre stand.
- Remove the tail guard, see (REMOVING THE TAIL GUARD)



- Remove the helmet compartment, see (REMOVING THE HELMET COMPARTMENT).



NOTE Before proceeding with the operations, take a container of adequate capacity to collect possible coolant spillage.

- Loosen the clamp.



- Slide the hose out.

NOTE Remove the expansion tank plug to let the coolant flow out.

- Drain the system.



- Working on the right side, loosen and remove the two side securing screws from rear mudguard and collect both shims.



- Working on the left side, loosen and remove the two side securing screws from rear mudguard and collect both washers.

NOTE On refitting, pay special attention to the length of the securing screws as the rear screw is shorter.



- Remove the mudguard.



SCARABEO 500

- Loosen and remove the securing screw from the oil recovery flange.



- Slide the flange out of its seat.



- Loosen the screw of the air filter inner support.



- Loosen the intake manifold clamp.
- Remove the bleeder.



- Remove the air box.



- Set up the lift hoist and fasten the vehicle suitably with the lifting slings.



- Loosen and remove the upper securing screw of the right shock absorber and collect the nut.



- Move the shock absorber away



- Loosen and remove the lower securing screw of the left shock absorber and collect the nut.



- Move the shock absorber away



- Loosen the adjusters and slide throttle cables out.



- Remove air temperature sensor.



NOTE Before proceeding with the operations, take a container of adequate capacity to collect possible coolant spillage.

- Loosen the thermostatic valve clamp.



- Remove the spark plug cap.



- Remove the injector control sensor.



- Slide the fuel lines out.



- Loosen and remove the securing screw of the fuel lines and collect the washer.



- Disconnect the coolant temperature sensor.



- Remove the clamp.



- Disconnect the lambda sensor connector.



- Disconnect the stepper motor connector.



- Disconnect the throttle position sensor.



- Loosen and remove the securing screw of the ground wires.



- Open cable guide
- Release the oil pressure sensor cable from the cable guide.



- Disconnect the oil pressure sensor.



- Working on both sides, loosen and remove the side securing screw.



- Slightly lift the central fairing.
- Remove and disconnect the generator connector.



- Loosen the exhaust manifold clamp.



- Loosen and remove the securing screw from the exhaust pipe clamp.
- Push in the exhaust and remove the upper pin securing the clamp.



- Loosen and remove the securing screw from the exhaust pipe.
- Remove the exhaust pipe.



- Remove the safety split pin.



- Remove the cap.



SCARABEO 500

- Have an assistant apply the rear brake while you loosen and remove the rear securing nut from the plate.



- Loosen and remove the two front securing nuts from the plate.



- Remove the support plate.



NOTE Place a suitable support on the vehicle lower side.

- Loosen and remove the five screws securing the wheel.
- Remove the wheel.



- Loosen and remove the securing screw from the rear brake line, collect the spacer.



- Loosen and remove the two securing screws from the rear brake calliper.
- Move the calliper away.



- Remove the protection element.



SCARABEO 500

- Loosen and remove the securing nut from the positive cable.
- Release the positive cable.



- Working on the right side, loosen and remove the securing nut from the swinging arm shaft and collect the washer.



- Remove the clamp.



- Loosen and remove the securing nut from the connecting rod and collect the washer and the silent block.



- Loosen the pin and collect the washer.



- Release slings from hoist supporting the vehicle rear end and remove the frame from the engine.



4.1.2. INSTALLING THE ENGINE

- Move the frame bit by bit until fastening holes are aligned.
- Fit the washer between swingarm shaft and frame during this procedure.
- Working on the left side, fit the shaft.



- Completely tighten the shaft fully home.



- Working on the right side, tighten engine shaft nut.



- Working on the left side, tighten the lock nut.
- Fasten the clamp.



- Set the silent block with washer and tighten the nut.



- Set the positive cable.
- Tighten the nut.



- Fit the protection element.



- Fit the rear brake calliper.
- Tighten the two securing screws on the rear brake calliper.



- Set the rear brake line guide and spacer, then tighten its screw.



- Fit the wheel.
- Tighten the five wheel screws.



- Fit the support plate.



- Fit and tighten the two front nuts on support plate.



- Fit the shim.



- Fit the plate rear nut.
- Have an assistant apply the rear brake while you tighten the rear securing nut on the plate.



- Fit the cap.



- Fit the safety split pin.



SCARABEO 500

- Fit the tailpipe.
- Fit and tighten the securing screw on the exhaust pipe.



- Fit and tighten the securing screw on the exhaust pipe clamp.
- Push in the exhaust and fit the upper pin securing the clamp.



- Fasten the exhaust manifold clamp.



- Slightly lift the central fairing.
- Connect the main connector and set it under the central fairing.



- Working on both sides, fit and tighten the side securing screw.



- Connect the oil pressure sensor.



- Fit the oil pressure sensor cable.
- Secure the two clamps.



- Connect the throttle position sensor.



- Connect the stepper motor connector.



- Connect the lambda sensor connector.
- Fasten the clamp.



- Connect the coolant temperature sensor.



- Fit the fuel lines.



- Fit the hose stop washer and then fit and tighten the fuel lines retaining screw.



- Fit the injector control sensor.



- Fit the spark plug cap.



- Fit the coolant hose.
- Tighten the clamp on thermostatic valve.



- Fit the air temperature sensor.



- Fit throttle cables and tighten the adjusters.



- Install the shock absorber.



- Set the shock absorber screw and tighten the nut.



- Install the shock absorber.



- Set the right shock absorber screw and tighten the nut.



- Fit the air box.
- Fit the bleeder.



- Fit the intake manifold and tighten the clamp.



- Fit and tighten the screw on air filter internal support.



- Fit the flange.



- Fit and tighten the securing screw from the oil recovery flange.



- Fit the mudguard.



- Working on the left side, fit and tighten the two side securing screws on rear mudguard with washers.



- Working on the right side, fit and tighten the two side securing screws on rear mudguard with shims.



- Fit the hose.
- Tighten the clamp.
- Fill up the cooling circuit.



- Set the helmet compartment, see (REMOVING THE HELMET COMPARTMENT).



- Set the tail guard, see (REMOVING THE TAIL GUARD)



CYCLE PARTS

5

SUMMARY

5.1.	OUTER STRUCTURES.....	3
5.1.1.	REMOVING THE SEAT	3
5.1.2.	REMOVING THE FRONT COVER	4
5.1.3.	REMOVING THE TAIL GUARD	5
5.1.4.	REMOVING THE HELMET COMPARTMENT	9
5.1.5.	REMOVING THE FOOTREST	13
5.1.6.	REMOVING THE INSTRUMENT PANEL	14
5.1.7.	REMOVING THE HEADLIGHT	15
5.1.8.	REMOVING THE SEAT RELEASING SYSTEM	17
5.2.	EXHAUST SYSTEM	18
5.2.1.	REMOVING THE EXHAUST SYSTEM	18
5.3.	FRONT WHEEL.....	20
5.3.1.	FRONT WHEEL DIAGRAM	20
5.3.2.	REMOVING THE FRONT WHEEL	21
5.4.	REAR WHEEL	22
5.4.1.	REAR WHEEL DIAGRAM.....	22
5.4.2.	REMOVING THE REAR WHEEL.....	23
5.5.	BRAKING SYSTEM.....	26
5.5.1.	BRAKING SYSTEM DIAGRAM.....	26
5.5.2.	CHANGING THE PADS.....	28
5.5.3.	REMOVING THE BRAKE FORCE DISTRIBUTION.....	30
5.6.	FRONT FORK	31
5.6.1.	FRONT FORK DIAGRAM	31
5.6.2.	REMOVING THE FORK LEGS	32
5.6.3.	DRAINING OIL	34
5.6.4.	DISASSEMBLING THE FORK.....	36
5.6.5.	FILLING OIL.....	38
5.6.6.	CHECKING THE COMPONENTS	40
5.6.7.	REASSEMBLING THE FORK.....	41

5.1. OUTER STRUCTURES

5.1.1. REMOVING THE SEAT

To remove the seat you first need to raise it. To do this you can:

- either use the supplied remote control and press the button (1) to automatically open the seat.



- or insert and press the key in the switch. The glove compartment opens automatically. Pull the left lever to manually open the seat.



- Raise the seat.
- Remove the central inspection cover.
- Remove the split pin.
- Remove the seat.

5.1.2. REMOVING THE FRONT COVER

- Position the vehicle on the centre stand.
- Completely turn the handlebar to the right and remove the top screw.

NOTE Proceed in the same way on the opposite side, turning handlebar to the left.



- Completely turn the handlebar to the right and remove the bottom screw.

NOTE Proceed in the same way on the opposite side, turning handlebar to the left.

- Slightly raise the cover lower end and remove it by sliding it out of the tabs.

**WARNING**

Proceed with care.

Do not damage the tabs and/or their seats.



When the front cover is removed you can gain access to:

- expansion tank;
- control unit;
- immobilizer;
- turn indicator lamps;
- voltage regulator,
- horn;
- relay
- bank angle sensor;

5.1.3. REMOVING THE TAIL GUARD

- Position the vehicle on the centre stand.
- Working on either side, open the passenger footrest.
- Working on either side, loosen and remove the three screws from footrests.

NOTE The rear screw is longer than the front ones, ensure to refit it in the correct position.

- Working on either side, remove both passenger footrests.



- Raise the seat.
- Loosen and remove the two top screws from central inspection cover.



- Loosen and remove the lower screw on central inspection cover



- Lower the seat.
- Remove the central inspection cover.



- Loosen and remove the two tail guard front screws.



- Working on either side, loosen and remove the two side lower screws.



- Loosen and remove the four screws from grab handle cover.



- Remove the cover.



- Loosen and remove the three screws securing the grab handle.

NOTE The centre screw is longer than the side ones, ensure to refit it in the correct position.



- Remove the tail light top cover.



- Loosen and remove the two tail guard rear screws.



- Partially slide out the tail guard together with tail light.



- Disconnect the three connectors.
- Remove the tail guard together with tail light.



5.1.4. REMOVING THE HELMET COMPARTMENT

- Raise the seat.
- Loosen and remove the two battery cover screws.
- Remove the battery cover.



- Remove the tail guard, see (REMOVING THE TAIL GUARD)
- Remove the seat, see (REMOVING THE SEAT)
- Disconnect the electrical connector.



- Disconnect the cable controlling opening of seat - actuator.



- Slide out the starter relay.



- Slide out cables from helmet compartment.



- Loosen and remove the screw securing the helmet compartment light switch.



- Disconnect the two connectors of helmet compartment light switch.



- Remove the helmet compartment light bulb.



- Loosen and remove the two front screws.



- Working on either side, loosen and remove the side screws.



- Loosen and remove the two rear screws.



- Loosen and remove the screws securing helmet compartment to number plate.



- Remove the helmet compartment.



5.1.5. REMOVING THE FOOTREST

- Remove the tail guard, see (REMOVING THE TAIL GUARD)
- Remove the inner front cover, see (REMOVING THE TANK)
- Remove the centre tunnel, see (REMOVING THE TANK)
- Loosen and remove the two bottom screws.



- Remove the plastic mat.



- Loosen and remove the two top screws.
- Remove the footrest.



5.1.6. REMOVING THE INSTRUMENT PANEL

- Remove the headlight, see (REMOVING THE HEADLIGHT).
- Working on either side, loosen and remove the two screws securing the front instrument panel fairing.
- Remove the front instrument panel fairing.



- Loosen and remove the two instrument panel top screws.



- Disconnect the instrument panel connector.



- Loosen and remove the two instrument panel bottom screws.
- Remove the instrument panel.



5.1.7. REMOVING THE HEADLIGHT

- Loosen and remove the securing screw from the headlight frame.



- Remove the headlight frame.



- Remove the top shell disengaging the tabs.



WARNING
Proceed with care.
Do not damage the tabs and/or their seats.



- Loosen and remove the two screws securing the headlight to the frame.



- Move aside the headlight and disconnect the connector.
- Carefully remove the headlight avoiding damages.



5.1.8. REMOVING THE SEAT RELEASING SYSTEM

- Remove the central inspection cover, see (REMOVING THE TAIL GUARD)
- Release the control cable.



- Release the control cable and the seat releasing cable.





- Remove the connector.
- Unscrew and remove the two screws.
- Remove the seat releasing system.



5.2. EXHAUST SYSTEM

5.2.1. REMOVING THE EXHAUST SYSTEM

- Loosen the exhaust manifold clamp.
- 
- Loosen and remove the securing screw from the exhaust pipe clamp.
 - Push in the exhaust and remove the upper pin securing the clamp.
- 
- Loosen and remove the securing screw from the exhaust pipe.
- 

- Remove the exhaust pipe.



5.3. FRONT WHEEL

5.3.1. FRONT WHEEL DIAGRAM

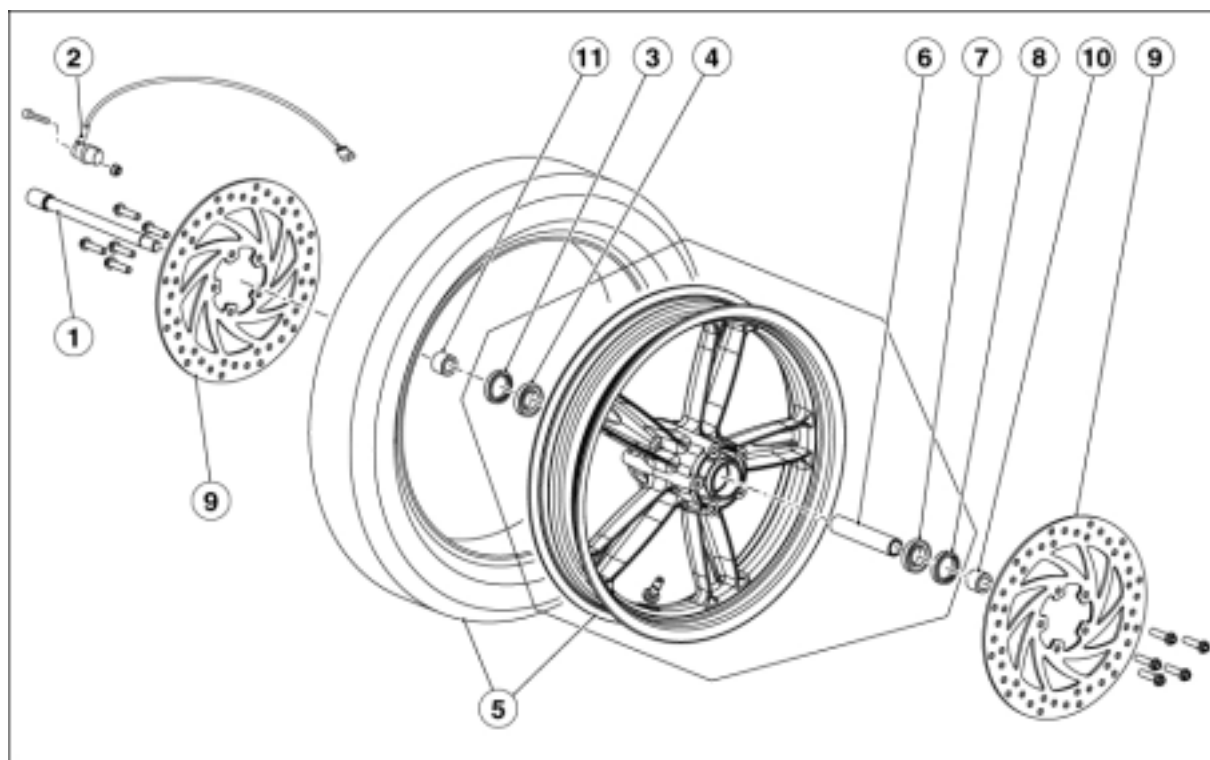
**Key:**

1. Wheel shaft
2. Odometer sensor
3. Right oil seal
4. Right bearing
5. Wheel
6. Inner spacer
7. Left bearing
8. Left oil seal
9. Brake discs
10. Left spacer
11. Right spacer

NOTE Grease wheel shaft (1).

5.3.2. REMOVING THE FRONT WHEEL

- Working on either side, loosen and remove the two screws from brake calliper.
- Slide off both callipers from the front brake discs.



- Place the vehicle on the front stand (**OPT**).
- Loosen the wheel shaft screw on right fork leg.



- Loosen and remove the wheel shaft.



- Remove the wheel and the two external spacers.



5.4. REAR WHEEL

5.4.1. REAR WHEEL DIAGRAM

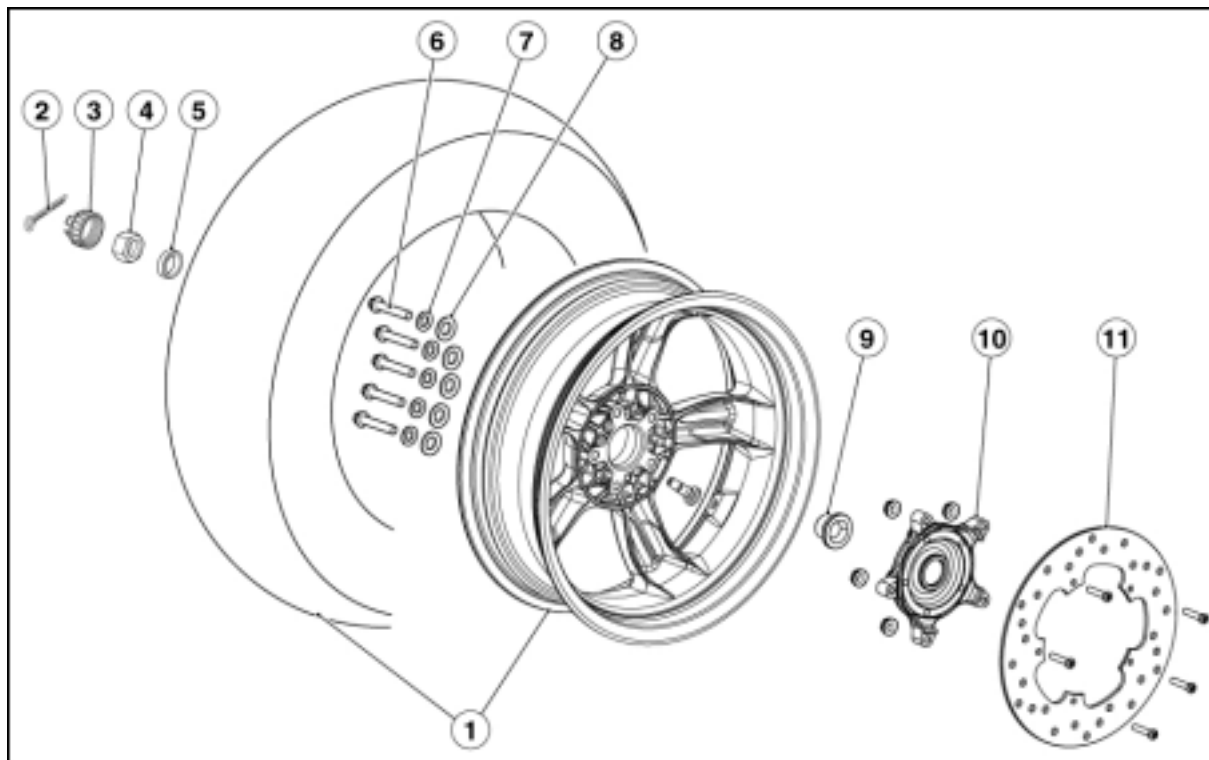

Key:

1. Complete wheel
2. Split pin
3. Cap
4. Nut
5. External spacer
6. Screw
7. Washer
8. Washer
9. Inner spacer
10. Wheel hub
11. Brake disc

5.4.2. REMOVING THE REAR WHEEL

- Working on the right side, loosen and remove the two side securing screws from rear mudguard and collect both shims.



- Loosen the exhaust manifold clamp.



- Loosen and remove the securing screw from the exhaust pipe clamp.
- Push in the exhaust and remove the upper pin securing the clamp.



- Loosen and remove the securing screw from the exhaust pipe.
- Remove the exhaust pipe.



- Remove the safety split pin.



- Remove the cap.



- Have an assistant apply the rear brake while you loosen and remove the rear securing nut from the plate.



- Loosen and remove the two front securing nuts from the plate.

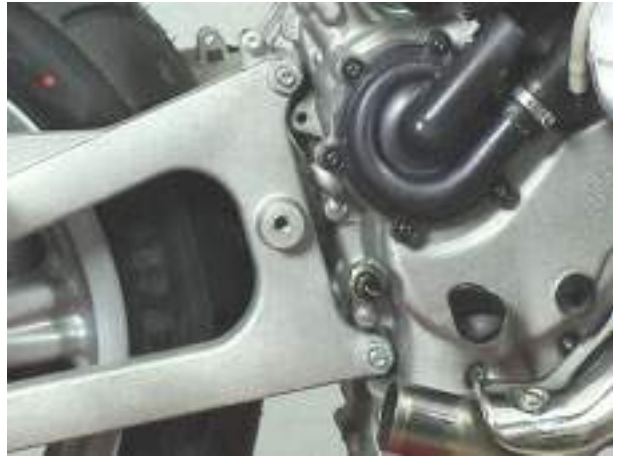

- Remove the support plate.



NOTE Place a suitable support on the vehicle lower side.

- Loosen and remove the five screws securing the wheel.
- Remove the wheel.



5.5. BRAKING SYSTEM

5.5.1. BRAKING SYSTEM DIAGRAM

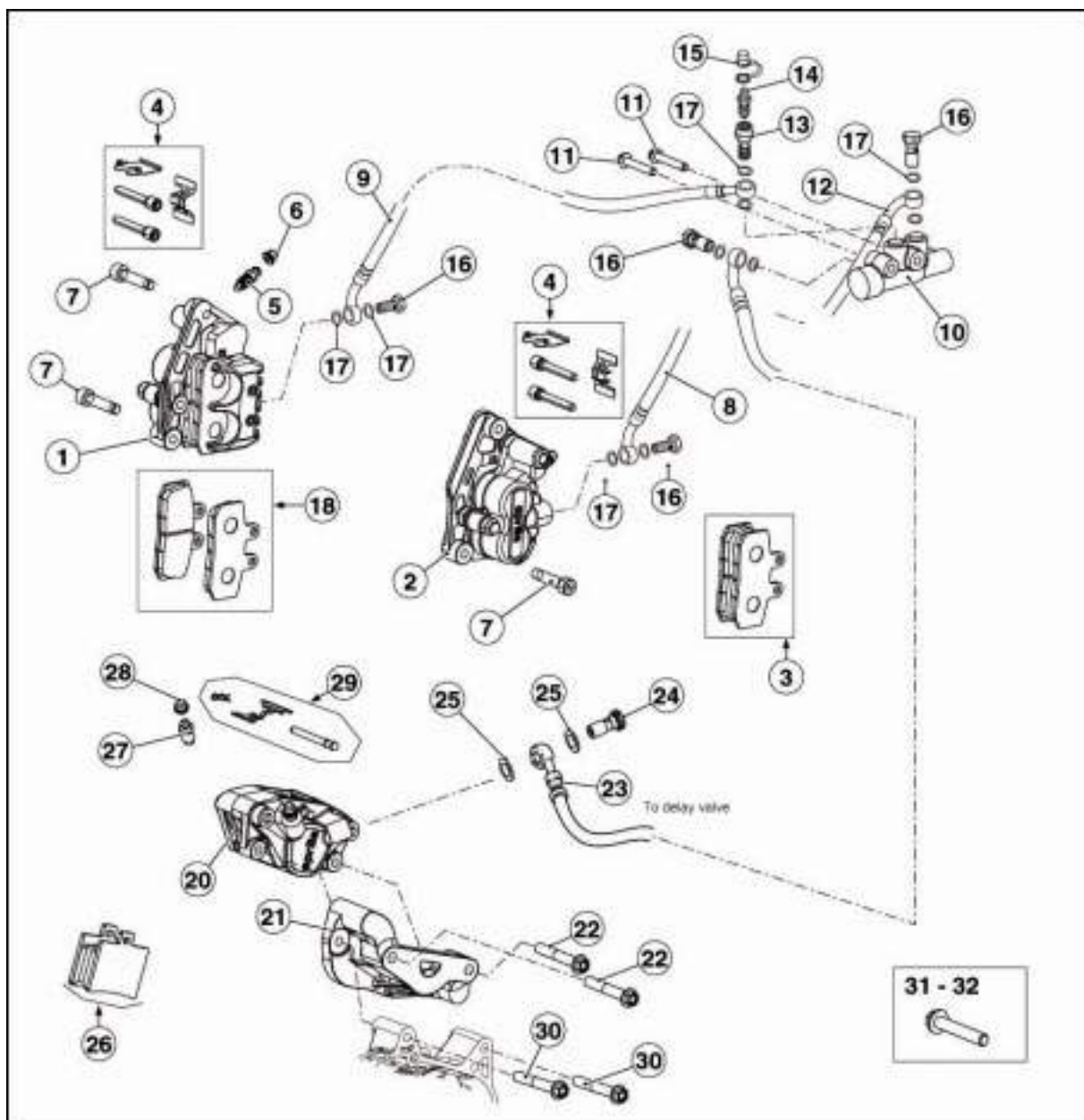

Key:

1. Front right brake calliper
2. Front left brake calliper
3. Pads – set
4. Kit pins + clip
5. Bleeder
6. Bleeder cap
7. TCEI screw M8x35
8. Front brake line
9. Front calliper brake force distributor line
10. Delay valve
11. Flanged Hex.screw M6X35
12. Brake line from m. cylinder to brake force distributor
13. Drilled screw
14. Bleeder
15. Bleeder cap
16. Oil line screw
17. Washer 10X14X1.6
18. Pads – sets
19. Kit for calliper ovhl
20. Rear brake calliper
21. Rear calliper mount
22. Flanged Hex.screw M8X40
23. Rear calliper brake force distributor line
24. Oil line screw
25. Washer 10X14X1.6
26. Pads – set
27. Bleeder
28. Bleeder cap
29. Kit pins + clip
30. Flanged Hex.screw M8X50
31. Flanged Hex.screw M6X16
32. Flanged Hex.screw M6X25

5.5.2. CHANGING THE PADS

FRONT BRAKE

- Remove the calliper, see (REMOVING THE FRONT WHEEL).
- Unscrew and remove the central screw (1).

**WARNING**

These operations apply to both brake callipers.



- Release the retainer (2).



- Slide off the two pins (3).



- Slide out the brake pads.

**WARNING**

Always change both pads and ensure they are correctly in place inside the calliper.
Do not reverse retainer (2) position upon reassembly.

- Install two new brake pads.
- Slide in the two pins (3).
- Refit the retainer (2).
- Tighten the central screw (1).
- Correctly install the brake callipers onto brake discs.



REAR BRAKE

- Remove the rear wheel, see (REMOVING THE REAR WHEEL).
- Remove the circlip.



- Slide the pin.



- Remove the spring.

**WARNING**

On spring is an arrow that should always be pointing in the direction of travel.



- Slide out the brake pads.

**WARNING**

Always change both pads and ensure they are correctly in place inside the calliper.

- Install two new brake pads.
- Insert the spring.
- Fit the pin.
- Fit the circlip.



5.5.3. REMOVING THE BRAKE FORCE DISTRIBUTION

- Remove the front cover, see (REMOVING THE FRONT COVER).
- Loosen and remove the three screws securing the immobilizer control unit.
- Move aside the immobilizer control unit keeping it connected to the wiring.



- Drain the braking system.
- Loosen and remove the two screws (1) and bleed valve (2), collect the gaskets.

NOTE Mark the brake lines to ensure correct position at reassembly.

- Protect the three brake lines to avoid fluid leakage.
- Loosen and remove the two screws (3) securing the brake force distributor.
- Remove the brake force distributor.

NOTE When reassembling, bleed the braking system, see (BRAKING SYSTEM).

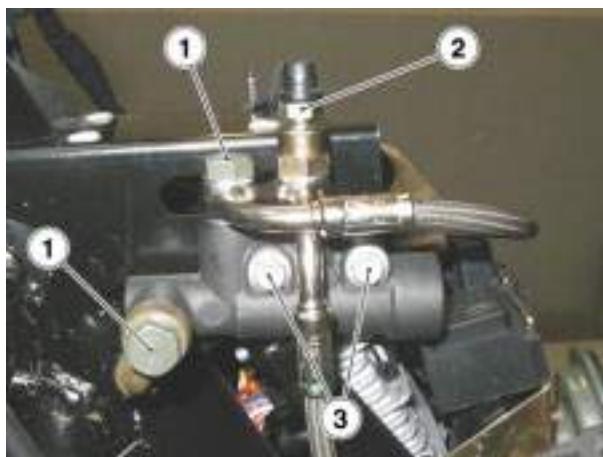

5.6. FRONT FORK

5.6.1. FRONT FORK DIAGRAM

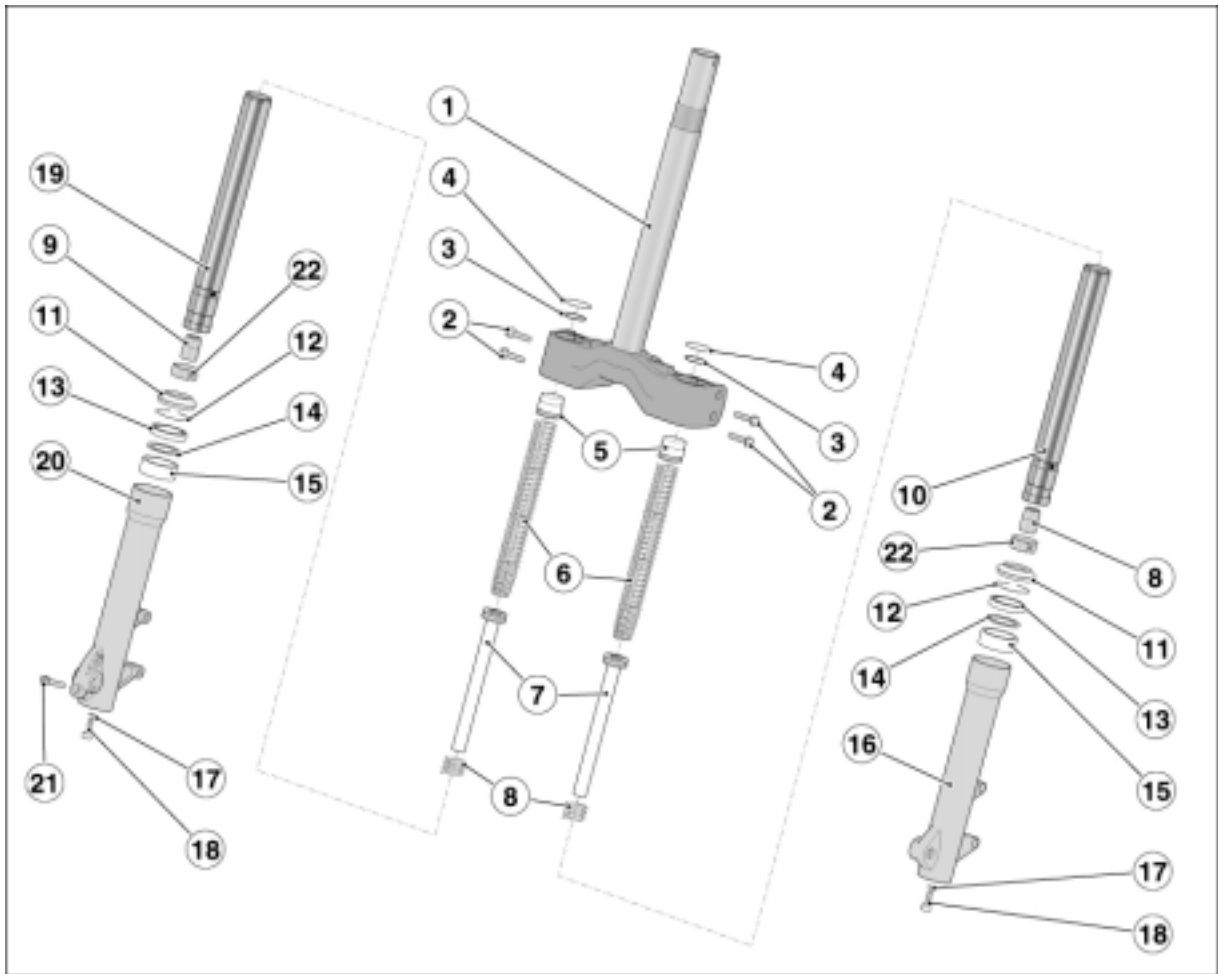

Key:

- 1. Fork base tube
- 2. Fork clamp screws
- 3. O-ring
- 4. Snap ring
- 5. Seal plug
- 6. Spring
- 7. Damping rod
- 8. Counter spring
- 9. Buffer
- 10. Left slider
- 11. Dust seal
- 12. Safety snap ring
- 13. Seal
- 14. Washer
- 15. Bushing
- 16. Left sleeve
- 17. Washer
- 18. Lower screw
- 19. Right slider
- 20. Right sleeve
- 21. Retaining screw
- 22. Sliding bush

5.6.2. REMOVING THE FORK LEGS

- Support the vehicle front end using slings and a hoist.
- Remove the front wheel, see (REMOVING THE FRONT WHEEL).
- Loosen and remove the front brake line guide screw.

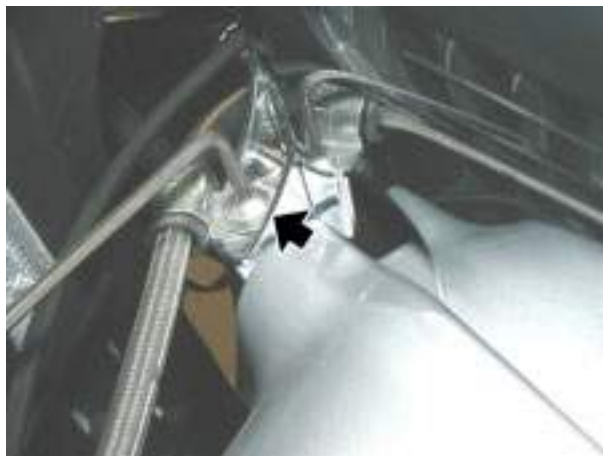

- Loosen and remove the screw inside leg guard.

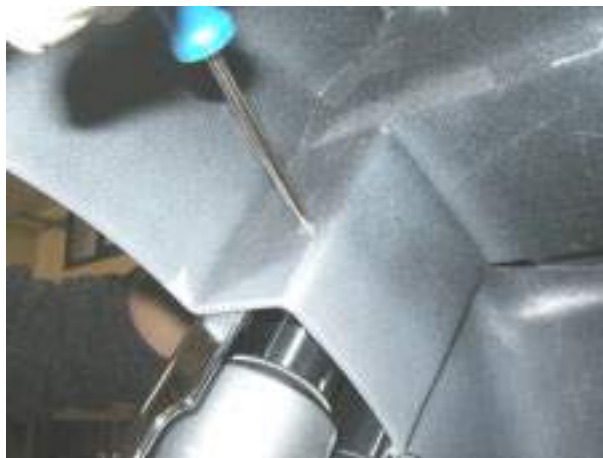

- Remove the leg guard.



- Loosen and remove the screw from speed sensor and collect the nut.



- Slacken the two fork leg retaining screws.



- Remove the top circlip (2).
- Remove the outer sleeve (3) sliding it off from the bottom.



5.6.3. DRAINING OIL

NOTE Before performing the following operations, prepare a container of suitable capacity.

- Set the sleeve in a vice.

**WARNING**

The slider and sleeve assembly is filled with oil: do not turn it upside-down or excessively tilt it during disassembly.



- Move down plug (1) until it is possible to remove circlip (2).
- Remove circlip (2).



- Remove plug (1) complete with O-ring.

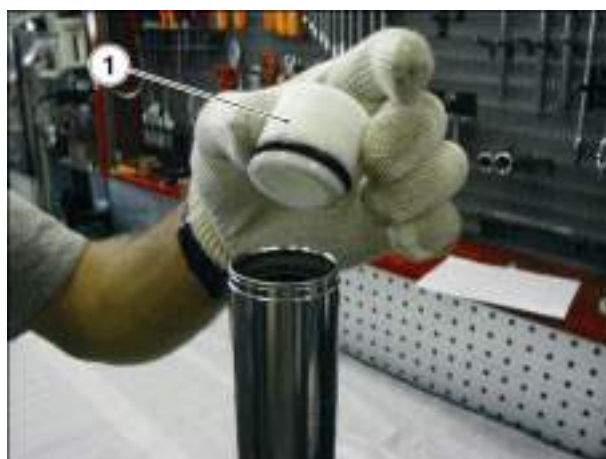

- Remove the spring (3) and allow a few seconds to let oil drip from it.



- Drain oil into the container pumping with the slider.



5.6.4. DISASSEMBLING THE FORK

- Drain oil, see (DRAINING OIL).
- Set the slider in a vice with soft jaws (aluminium).
- Unscrew and remove the lower screw (1), collect the washer.



- Slide the slider off the sleeve and collect the bushing.



- Slide off the damper rod (2) from the slider and remove the spring (3).



- Remove the dust seal (4) from sleeve.



- Remove the circlip (5) from sleeve.



- Remove the oil seal (6) from sleeve.

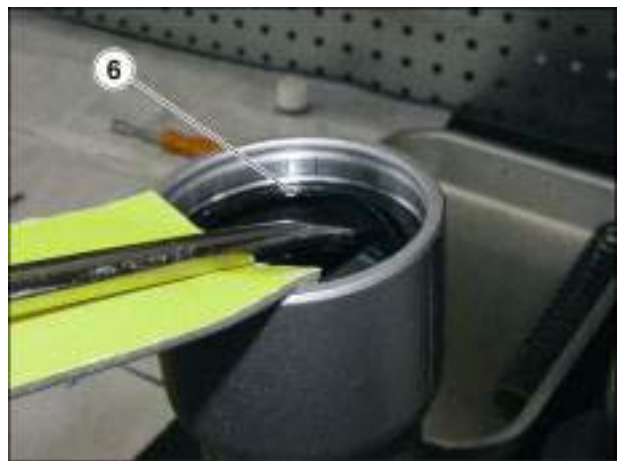

- Remove the washer (7) from sleeve.

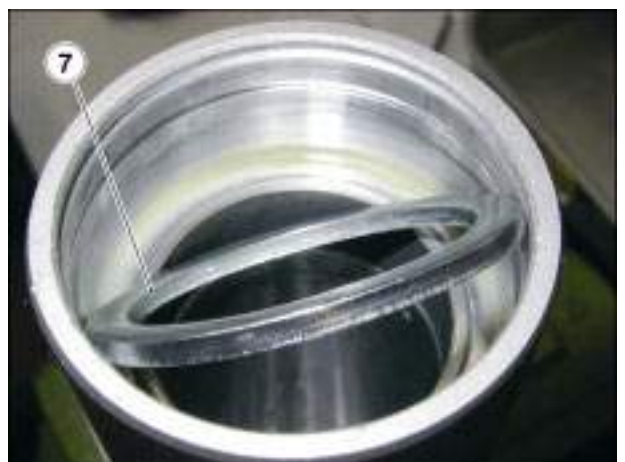

- Remove the shell (8) from sleeve.



5.6.5. FILLING OIL

- Set the slider and sleeve assembly in a vice with soft jaws (aluminium).



- Pour fork oil in the assembly.



WARNING
Do not reuse oil that was previously drained.



- Insert the spring.



- Fit plug (1) complete with O-ring.



SCARABEO 500

- Move down plug (1) until it is possible to fit circlip (2).
- Fit circlip (2).



5.6.6. CHECKING THE COMPONENTS**OUTER SLEEVE**

- Inspect the sliding surface for scoring and/or scratching. Eliminate minor scoring with wet sand paper (grain size 1).
- Replace the stanchion if badly scored.
- Check for stanchion buckling using a dial gauge.
- Replace the stanchion if buckled beyond the service limit.

Max. allowed buckling: 0.2 mm.

**DANGER**

NEVER attempt to straighten a buckled stanchion as this would weaken the overall structure leading to a dangerous riding condition.

SLIDER

- Inspect for damage and/or cracking. Replace if damaged.
- Change any component which is badly worn or damaged.

Renew the following components on assembly:

- O-ring on plug (1);

- oil seal (2);

- dust seal (3);

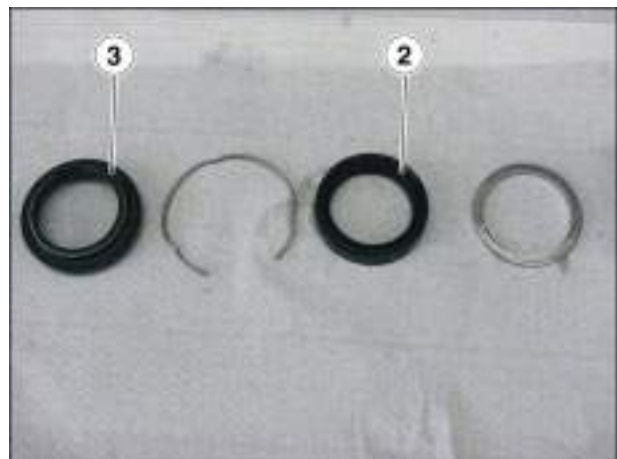

5.6.7. REASSEMBLING THE FORK

- Set the sleeve in a vice with soft jaws (aluminium).
- Fit spacer (1).



WARNING
Ensure that no foreign matter enters inside the sleeve and slider.

NOTE Before refitting the seals and bushings, smear them with a film of fork oil.



- Insert the washer.



- Fit the oil seal.



- Install the snap ring.



- Fit the dust seal.



- Install the damper rod and the spring in slider.



- Install slider with bushing (2) in sleeve.



- Tighten bottom screw (3) with washer.
- Fill with oil, see (FILLING OIL).



COOLING SYSTEM

6

SUMMARY

6.1. COOLING SYSTEM 3
6.1.1. COOLING SYSTEM DIAGRAM 3
6.1.2. CHANGING THE COOLANT 4
6.1.3. REMOVING THE EXPANSION TANK 5

6.1. COOLING SYSTEM

6.1.1. COOLING SYSTEM DIAGRAM

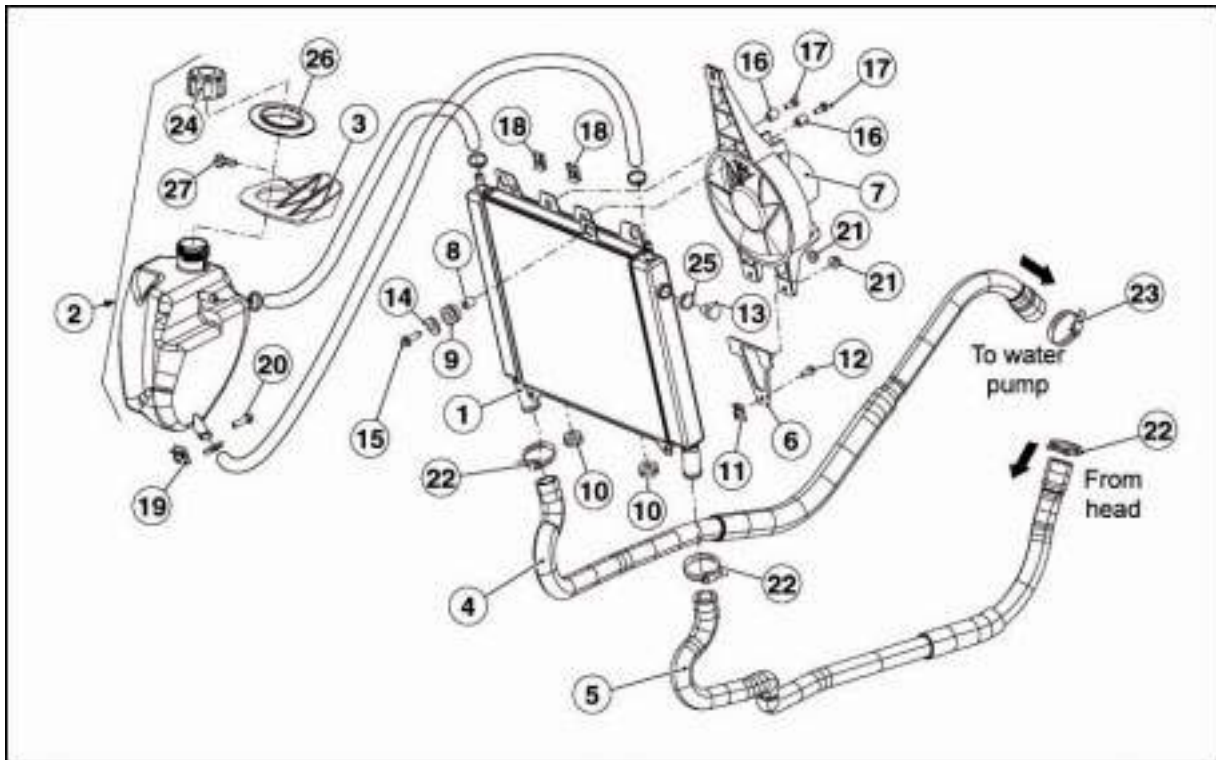

Key:

1. Radiator
2. Expansion tank
3. Expansion tank support
4. Head-radiator hose
5. Pump-radiator hose
6. Electric fan mount
7. Electric fan
8. Spacer bushing
9. Top rubber block
10. Bottom rubber block
11. Clip M5
12. Flanged Hex.screw M5X12
13. Plug
14. Washer 6.6X18X1.6
15. Flanged Hex.screw M6X20
16. Bushing
17. Flanged Hex.screw M5X12
18. Clip M5
19. Clip M6
20. Flanged self-locking nut M6
21. Clamp D.16 24X8
22. Clamp D.16 24X8
23. Hose clamp
24. Expansion tank plug
25. Aluminium washer 14X22X1
26. Filler rubber element
27. Flanged TBEI screw M6X16

6.1.2. CHANGING THE COOLANT

DRAINING

NOTE Before proceeding with the operations, take a container of adequate capacity to collect possible coolant spillage.

- Loosen the clamp.



- Slide the hose out.

NOTE Remove the expansion tank plug to let the coolant flow out.

- Drain the system.



FILLING

- Refit the hose.
- Secure it with clamp.
- Remove the central inspection cover.
- Remove the rubber cap.
- Slacken bleed valve and fit a tube, set the other end of tube in a container.
- Top up expansion tank with coolant, see (COOLANT), until level reaches approximately "MAX" mark.
- Bleed any air, tighten the valve and carry on filling with fluid up to "MAX" mark.
- Start the engine and warm it up.
- Bleed air again and top up.



6.1.3. REMOVING THE EXPANSION TANK

- Drain the cooling system, see (CHANGING COOLANT).
- Remove the front cover, see (REMOVING THE FRONT COVER).
- Detach breather tube (3) from expansion tank.
- Loosen and remove the top screw (1) from expansion tank.

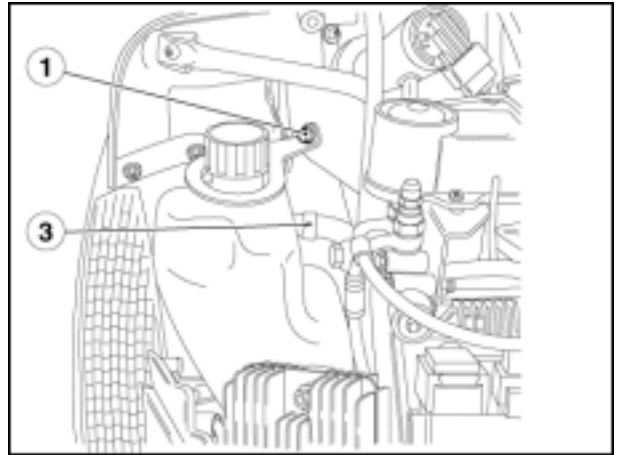

- Open the glove compartment.
- Loosen the bottom screw (4) from expansion tank through glove compartment hole.
- Raise the expansion tank and disconnect the cooling system lower tube.
- Remove the expansion tank.

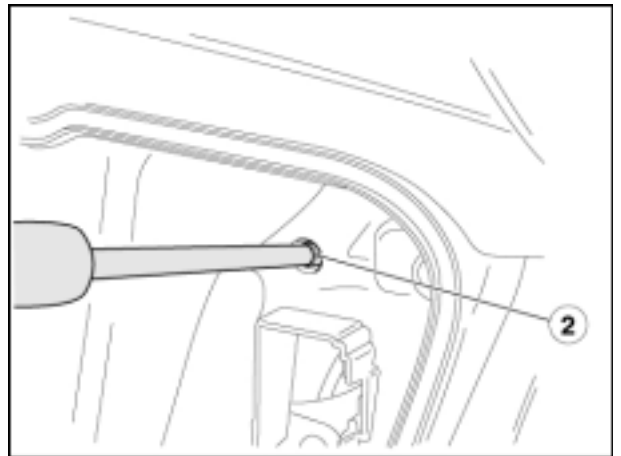

ELECTRICAL SYSTEM

7

SUMMARY

7.1. ELECTRIC COMPONENTS 3
7.1.1. CHECKING THE ELECTRICAL COMPONENTS 3
7.1.2. WIRING DIAGRAM 5

7.1. ELECTRIC COMPONENTS

7.1.1. CHECKING THE ELECTRICAL COMPONENTS

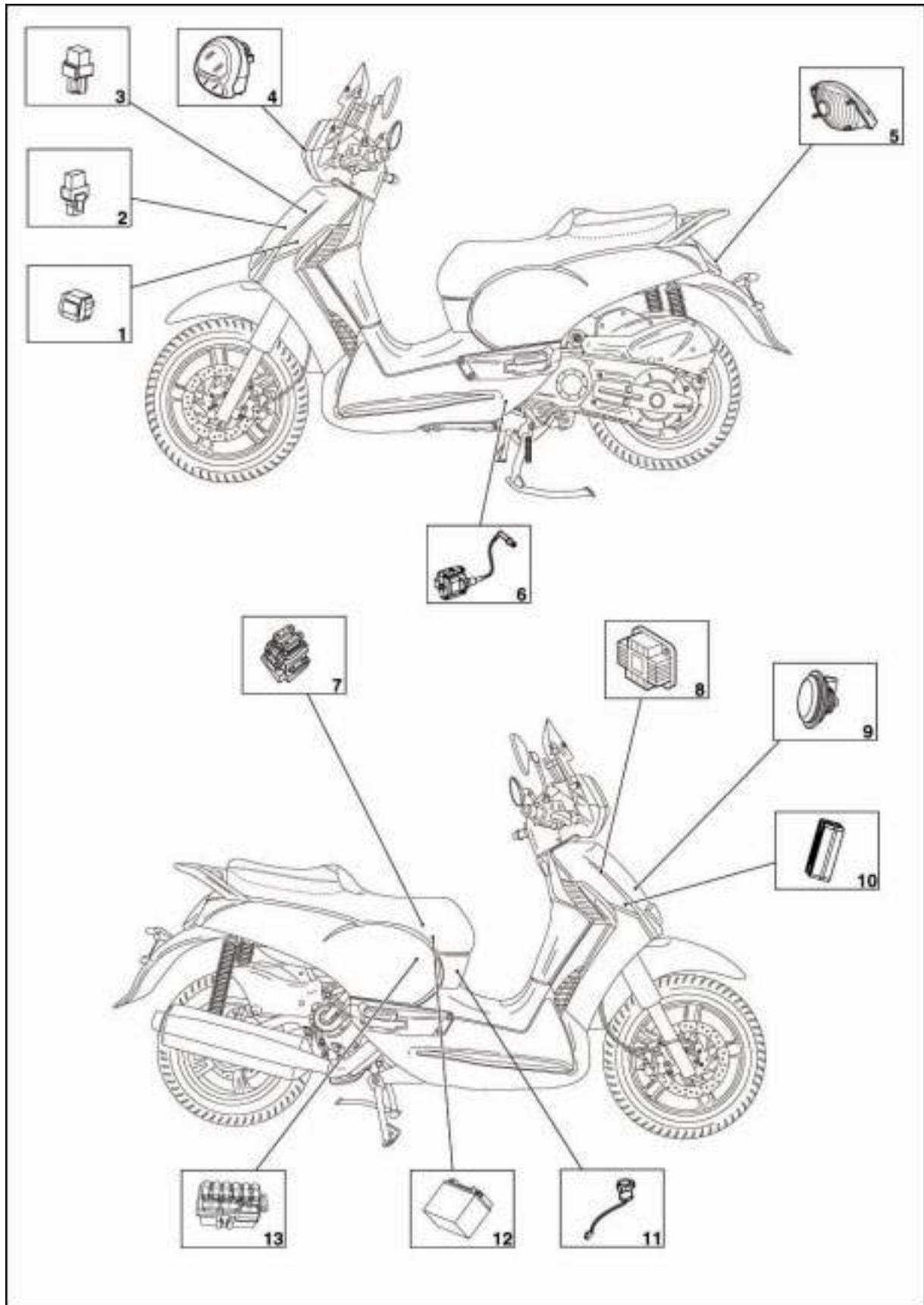

Key:

1. Bank angle sensor
2. 30A Starter relay
3. 30A relay with diode
4. Headlight
5. Tail light
6. Coil with cable and cap
7. Main fuses
8. ECU
9. Warning horn
10. Voltage regulator
11. 150A Starter relay
12. 12V Battery
13. Auxiliary fuses

7.1.2. WIRING DIAGRAM

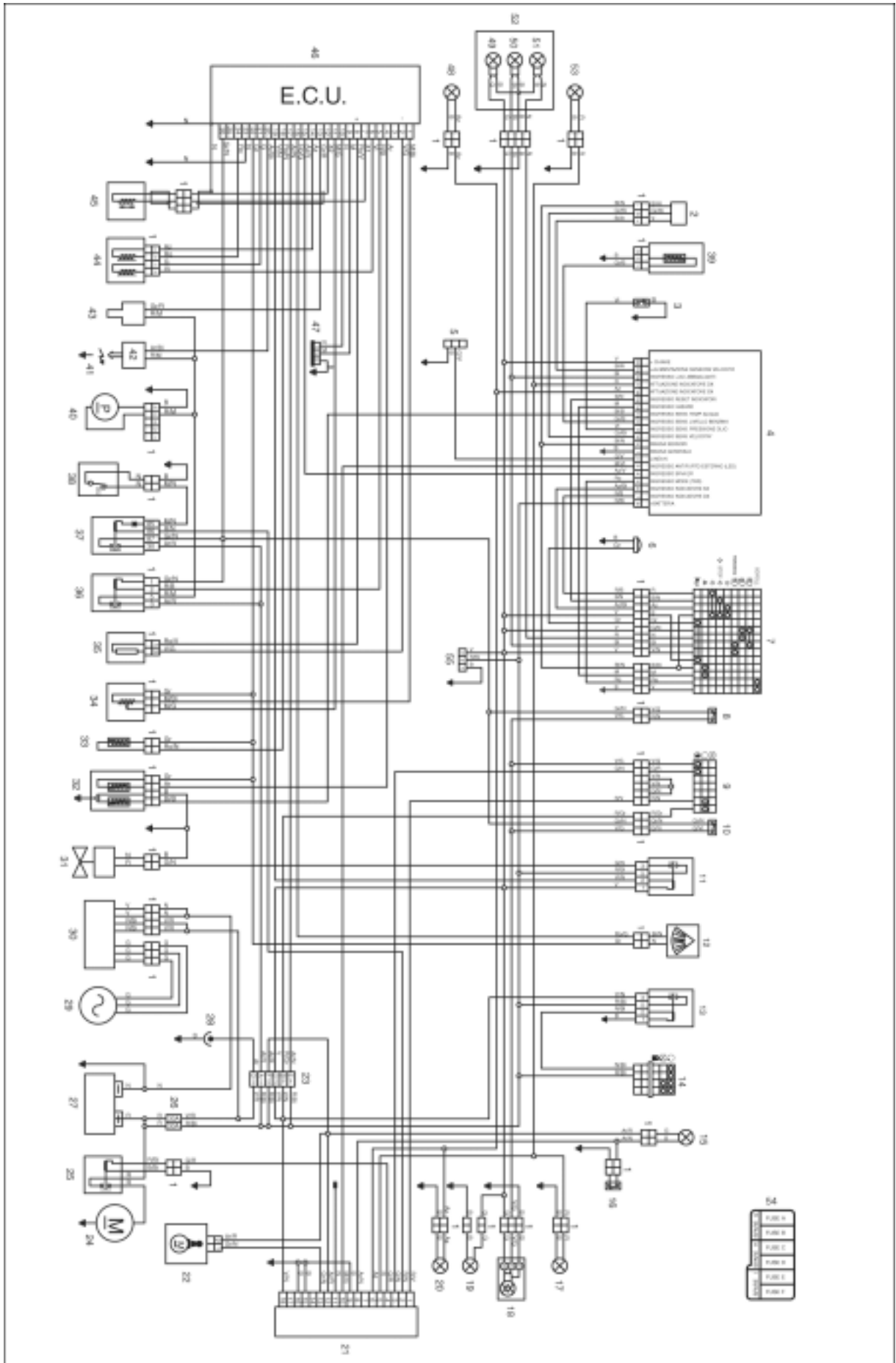

Key:

1. Multiple connectors
2. Speed sensor
3. Oil pressure sensor
4. Instrument panel
5. Instr. panel Diag.
6. Warning horn
7. Left dimmer switch
8. Rear stoplight switch
9. Left dimmer switch
10. Front stoplight switch
11. Fan relay
12. Bank angle sensor
13. Key relay
14. Key-operated switch
15. Case compartment light
16. Compartment light switch
17. Rear right turn indicator
18. Tail light
19. Number plate light
20. Rear left turn indicator
21. Antitheft system control unit
22. Case lock
23. Auxiliary fuses
24. Starter motor
25. Starter relay
26. Main fuses
27. Battery
28. Power output
29. Generator
30. Voltage regulator
31. Fan
32. H2O thermistor - engine/instrument panel
33. Engine air thermistor
34. Throttle sensor
35. Lambda sensor
36. Auxiliary injection relay
37. Main injection relay (polarised)
38. Stand switch
39. Fuel level sensor
40. Fuel pump
41. Spark plug
42. Coil
43. Fuel injector
44. Stepper motor
45. Rpm sensor
46. ECU
47. ECU diagnostics socket
48. Front left turn indicator
49. Front parking light
50. High beam
51. Low beam
52. Headlight
53. Front right turn indicator
54. Sticker and description of auxiliary fuses
55. Radio power supply

WIRE COLOUR CODING

Ar	Orange
Az	Light blue
B	Blue
Bi	White
G	Yellow
Gr	Grey
M	Brown
N	Black
R	Red
V	Green
Vi	Violet
Ro	Pink

AUXILIARY FUSES:

A	5A	INJECTION, STOP LIGHTS, STARTING
B	3A	LOGICS / ENGINE KILL
C	15A	LIGHTS, HORN, INSTRUMENT PANEL, FAN RELAY
D	15A	POWER OUTPUT
E	3A	E.C.U. PERMANENT POWER SUPPLY
F	10A	E.C.U. ALARM, ELECTRIC LOCK, CASE LIGHT
G	15A	SPARE FUSE
H	3A	SPARE FUSE
I	10A	SPARE FUSE



aprilia
via G. Galilei, 1
30033 Noale (VE) Italy
tel. +39 041.5829111
fax +39 041.5801674
www.aprilia.com