

aprilia



use and maintenance

aprilia part# 8102759

Pegaso 650

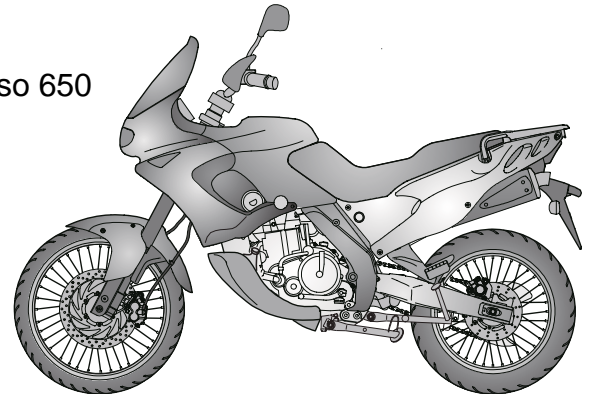

SAFETY WARNINGS

The following precautionary warnings are used throughout this manual in order to convey the following messages:

 **Safety warning. When you find this symbol on the vehicle or in the manual, be careful to the potential risk of personal injury. Non-compliance with the indications given in the messages preceded by this symbol may result in grave risks for your and other people's safety and for the vehicle!**

 **Indications to make the operations easier. Technical information.**

First edition: december 1996

Reprint: january 2000

Produced and printed by:
stp editing division
Soave (VERONA) - Italy
Tel. +39 - 045 76 11 911
Fax +39 - 045 76 12 241
E-mail: customer@stp.it
www.stp.it

On behalf of:
aprilia s.p.a.
via G. Galilei, 1 - 30033 Noale (VE) - Italy
Tel. +39 - 041 58 29 111
Fax +39 - 041 44 10 54
www.aprilia.com

TECHNICAL

★ The operations preceded by this symbol must be repeated also on the opposite side of the vehicle.

If not expressly indicated otherwise, for the reassembly of the units repeat the disassembly operations in reverse order.

The terms "right" and "left" are referred to the rider seated on the vehicle in the normal riding position.

WARNINGS - PRECAUTIONS - GENERAL ADVICE

Before starting the engine, carefully read this manual and in particular the section "SAFE DRIVE".

Your and other people's safety depends not only on your quickness of reflexes and on your agility, but also on what you know about the vehicle, on its efficiency and on your knowledge of the basic information for "SAFE DRIVE". Therefore, get a thorough knowledge of the vehicle, in such a way as to be able to drive in the traffic safely.

 This manual must be considered as an integral part of the vehicle and must always accompany it, even in case of resale.

aprilia has carried out this manual with the maximum attention, in order to supply the user with correct and updated information. However, since **aprilia** constantly improves the design of its products, there may be slight discrepancies between the characteristics of your vehicle and those described in this manual. For any clarification concerning the information contained in this manual, do not hesitate to contact your **aprilia** Official Dealer.

For control and repair operations not expressly described in this publication, for the purchase of **aprilia** genuine spare parts, accessories and other products, as well as for specific advice, contact exclusively **aprilia** Official Dealers and Service Centers, which guarantee prompt and accurate assistance.

Thank you for choosing **aprilia**. We wish you a nice ride.

All rights as to electronic storage, reproduction and total or partial adaptation, with any means, are reserved for all Countries.

 In some countries the antipollution and noise regulations in force require periodical inspections.

The user of the vehicle in these countries must:

- contact an **aprilia** Authorized Dealer to have the non-homologated components replaced with others homologated for use in the country in question;
- carry out the required periodical inspections.

 When asking your Dealer for spare parts, specify the spare parts code indicated on the SPARE PARTS IDENTIFICATION LABEL.

Write down the identification code in the space here below, in order to remember it also in case of loss or deterioration of the label.

The label is positioned under the rider saddle, stuck to the frame.

aprilia N°				YEAR	T	V	W	X	Y
SPARE PARTS CODE NUMBER				I.M.	A	B	C	D	E
I	UK	A	P	SF	B	D	F	E	GR
NL	CH	DK	J	SGP	PL	IL	ROK	MAL	RCH
BM	USA	AUS	BR	RSA	NZ	CDN	HR	SLO	

In this manual the various versions are indicated by the following symbols:

OPT optional

 catalytic version

VERSION:

- I** Italy
- UK** United Kingdom
- A** Austria
- P** Portugal
- SF** Finland
- B** Belgium
- D** Germany
- F** France
- E** Spain
- GR** Greece
- NL** Holland
- CH** Switzerland
- DK** Denmark
- J** Japan
- SGP** Singapore
- PL** Poland
- IL** Israel
- ROK** South Korea
- MAL** Malaysia
- RCH** Chile
- BM** Bermuda
- USA** United States of America
- AUS** Australia
- BR** Brazil
- RSA** South Africa
- NZ** New Zealand
- CDN** Canada
- HR** Croatia
- SLO** Slovenia

TABLE OF CONTENTS

SAFE DRIVE	5	CHECKING THE ENGINE OIL LEVEL AND TOPPING UP	39
BASIC SAFETY RULES:.....	6	CHANGING THE ENGINE OIL AND THE OIL FILTER	40
CLOTHING	9	FRONT WHEEL.....	42
ACCESSORIES.....	10	REAR WHEEL	44
LOAD.....	10	CHAIN.....	46
ARRANGEMENT OF THE MAIN ELEMENTS	12	REMOVING THE FUEL TANK.....	48
ARRANGEMENT OF THE INSTRUMENTS	14	REMOVING	
INSTRUMENTS AND INDICATORS	14	THE RIGHT AND LEFT SIDES.....	48
INSTRUMENTS AND INDICATORS TABLE.....	15	CHECKING THE STEERING.....	49
MAIN INDEPENDENT CONTROLS	16	CHECKING	
CONTROLS ON THE LEFT SIDE OF THE HANDLEBAR.....	16	THE REAR FORK FULCRUM AXIS	49
CONTROLS ON THE RIGHT SIDE OF THE HANDLEBAR	17	INSPECTING THE FRONT AND REAR SUSPENSIONS	49
IGNITION SWITCH.....	18	REAR SUSPENSION.....	50
STEERING LOCK.....	18	REAR SUSPENSION	
AUXILIARY EQUIPMENT	19	WITH HYDRAULIC PRELOAD ADJUSTMENT Opt	50
UNLOCKING/LOCKING THE SADDLE.....	19	IDLING ADJUSTMENT	52
GLOVE/TOOL KIT COMPARTMENT	19	ADJUSTING THE ACCELERATOR CONTROL	52
CRASH HELMET HOOK	20	ADJUSTING THE COLD START CONTROL (I\N).....	52
ANTI-THEFT HOOK.....	20	SPARK PLUG	53
REAR LUGGAGE RACK	20	BATTERY.....	54
MAIN COMPONENTS	21	CHECKING THE ELECTROLYTE LEVEL.....	55
FUEL.....	21	RECHARGING THE BATTERY.....	55
ENGINE OIL	21	LONG INACTIVITY OF THE BATTERY	55
BRAKE FLUID (recommendations)	22	CHANGING THE FUSES.....	56
DISC BRAKES.....	22	CHECKING THE SIDE STAND AND THE SAFETY SWITCH	57
FRONT BRAKE	23	ADJUSTING	
REAR BRAKE	24	THE HEADLIGHT BEAM	58
ADJUSTING THE REAR BRAKE	24	BULBS	58
CLUTCH	25	CHANGING THE HEADLIGHT BULBS	59
COOLANT	26	CHANGING THE REAR LIGHT BULB.....	60
TYRES	27	CHANGING THE FRONT DIRECTION INDICATOR BULBS	60
EXHAUST SILENCERS AUS	28	CHANGING THE REAR DIRECTION INDICATOR BULBS	61
CATALYTIC SILENCERS CA	28	CHANGING	
INSTRUCTIONS FOR USE	29	THE NUMBER PLATE BULB.....	61
PRELIMINARY CHECKING OPERATIONS.....	29	TRANSPORT	62
STARTING.....	30	DRAINING THE FUEL TANK.....	62
DEPARTURE AND DRIVE	32	CLEANING	63
RUNNING-IN	34	LONG PERIODS OF INACTIVITY	64
STOPPING	34	TECHNICAL DATA	65
PARKING.....	34	LUBRICANT TABLE	68
SUGGESTIONS TO PREVENT THEFT	35	Importers.....	70-71
MAINTENANCE	36	WIRING DIAGRAM - Pegaso 650.....	72
REGULAR SERVICE INTERVALS CHART	36	WIRING DIAGRAM KEY - Pegaso 650	73
IDENTIFICATION DATA.....	37		
AIR CLEANER.....	38		

aprilia



safe drive



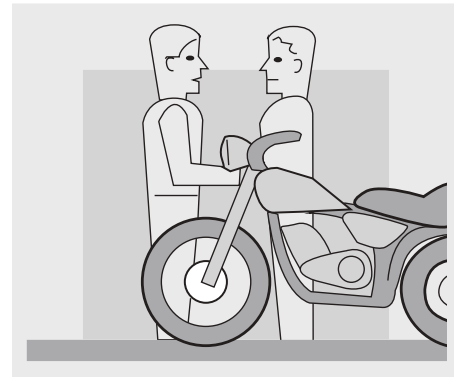
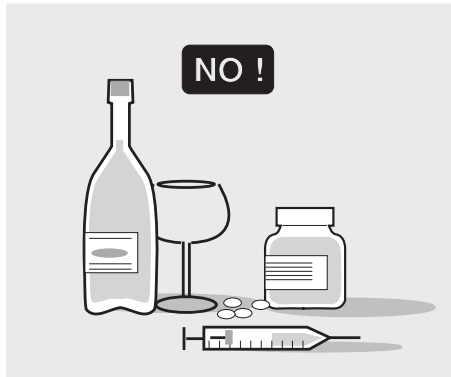

BASIC SAFETY RULES

To drive the vehicle it is necessary to be in possession of all the requirements prescribed by law (driving licence, minimum age, psychophysical ability, insurance, state taxes, vehicle registration, number plate, etc.).

Gradually get to know the vehicle by driving it first in areas with low traffic and/or private areas.

The use of medicines, alcohol and drugs or psychotropic substances notably increases the risk of accidents.

Be sure that you are in good psychophysical conditions and fit for driving and pay particular attention to physical weariness and drowsiness.

Most road accidents are caused by the driver's lack of experience.

NEVER lend the vehicle to beginners and, in any case, make sure that the driver has all the requirements for driving.

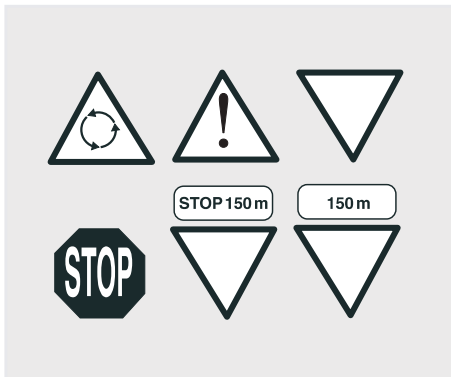

Rigorously observe all road signs and national and local road regulations. Avoid abrupt movements that can be dangerous for yourself and other people (for example: rearing up on the back wheel, speeding, etc.), and give due consideration to the road surface, visibility and other driving conditions.

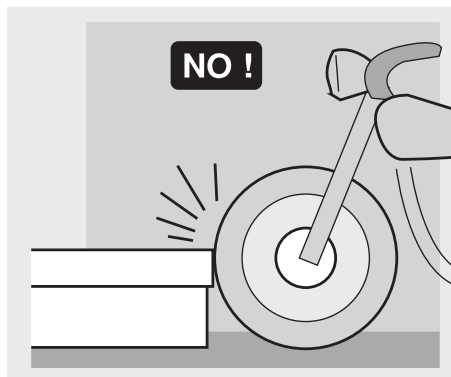

Avoid obstacles that could damage the vehicle or make you lose control. Avoid riding in the slipstream created by preceding vehicles in order to increase your speed.

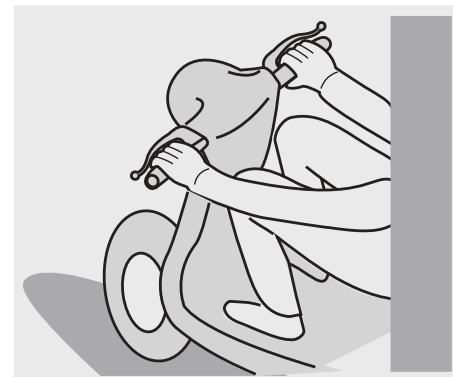

Always drive with both hands on the handlebars and both feet on the footrests (or on the rider's footboards), in the correct driving posture. Avoid standing up or stretching your limbs while driving.

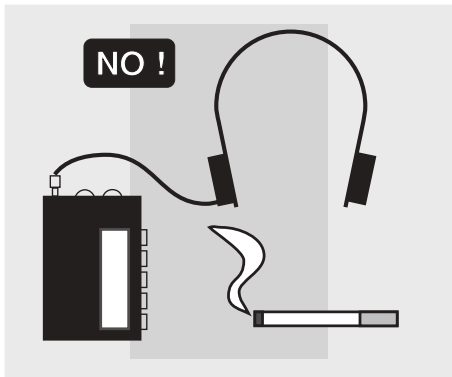

The driver should pay attention and avoid distractions caused by people, things and movements (never smoke, eat, drink, read, etc.) while driving.

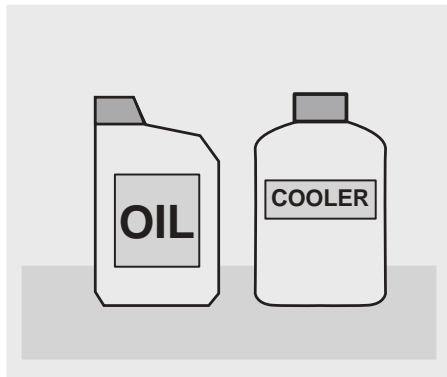

Use only the vehicle's specific fuels and lubricants indicated in the "LUBRICANT CHART"; check the oil, fuel and coolant levels regularly.

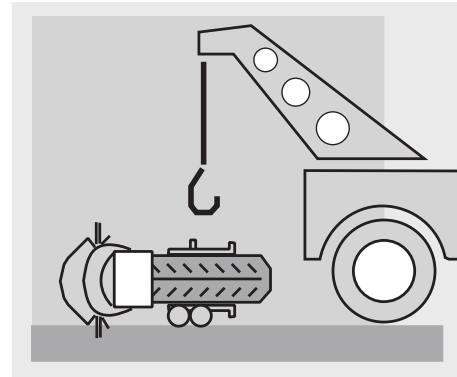

If the vehicle has been involved in an accident, make sure that no damage has occurred to the control levers, pipes, wires, braking system and vital parts.

If necessary, have the vehicle inspected by an **aprilia** Official Dealer, who should carefully check the frame, handlebars, suspensions, safety parts and all the devices that you cannot check by yourself.

Always remember to report any malfunction to the technicians to help them in their work.

Never use the vehicle when the amount of damage it has suffered endangers your safety.

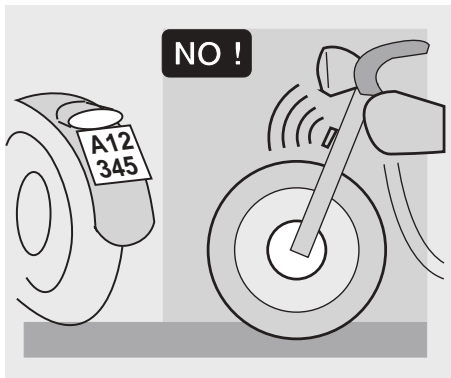

Never change the position, inclination or colour of: number plate, direction indicators, lights and horns.

Any modification of the vehicle will result in the invalidity of the guarantee.

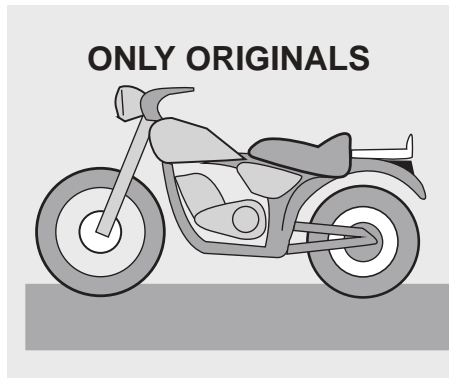

Any modification of the vehicle and/or the removal of original components can compromise vehicle performance levels and safety or even make it illegal.

We recommend respecting all regulations and national and local provisions regarding the equipment of the vehicle.

In particular, avoid all modifications that increase the vehicle's performance levels or alter its original characteristics.

Never race with other vehicles.

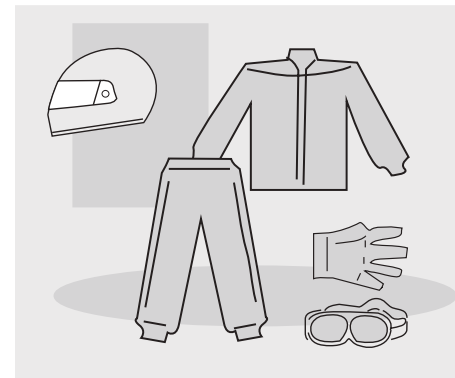

CLOTHING

Before starting, always wear a correctly fastened crash helmet. Make sure that it is homologated, in good shape, of the right size and that the visor is clean.

Wear protective clothing, preferably in light and/or reflecting colours. In this way you will make yourself more visible to the other drivers, thus notably reducing the risk of being knocked down, and you will be more protected in case of fall.

This clothing should be very tight-fitting and fastened at the wrists and ankles. Strings, belts and ties should not be hanging loose; prevent these and other objects from interfering with driving by getting entangled with moving parts or driving mechanisms.

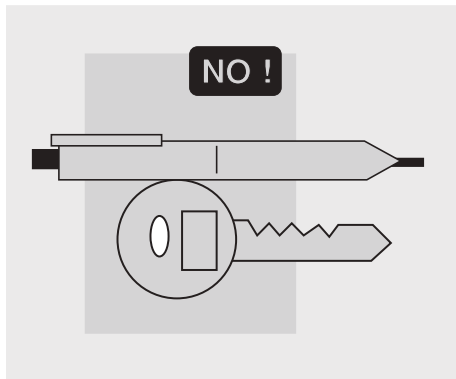

Do not keep objects that can be dangerous in case of fall, for example pointed objects like keys, pens, glass vials etc. in your pockets (the same recommendations also apply to passengers).

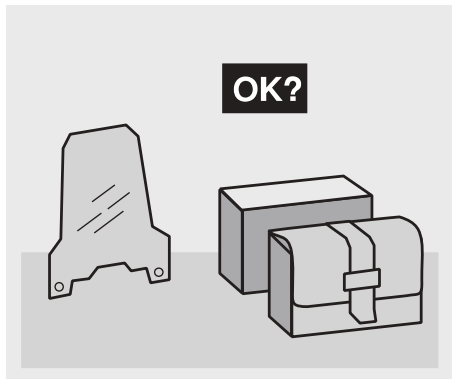

ACCESSORIES

The owner of the vehicle is responsible for the choice, installation and use of any accessory.

Avoid installing accessories that cover horns or lights or that could impair their functions, limit the suspension stroke and the steering angle, hamper the operation of the controls and reduce the distance from the ground and the angle of inclination in turns.

Avoid using accessories that hamper access to the controls, since this can prolong reaction times during an emergency.

Large fairings and windscreens assembled on the vehicle can produce aerodynamic forces capable of compromising the stability of the vehicle while driving.

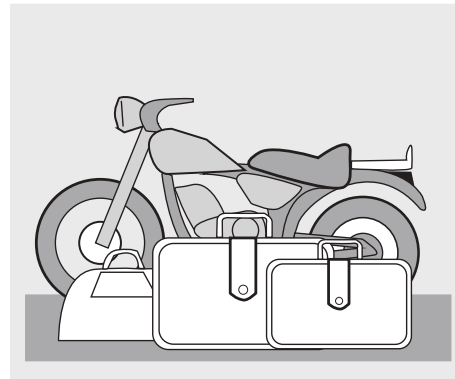

Make sure that the equipment is well fastened to the vehicle and not dangerous during driving. Do not install electrical devices and do not modify those already existing to avoid electrical overloads, because the vehicle could suddenly stop or there could be a dangerous current short-**age** in the horn and in the lights. **aprilia** recommends the use of genuine accessories (**aprilia** genuine accessories).

LOAD

Be careful and moderate when loading your luggage. Keep any luggage loaded as close as possible to the centre of the vehicle and distribute the load uniformly on both sides, in order to reduce imbalance to the minimum. Furthermore, make sure that the load is firmly secured to the vehicle, especially during long trips.

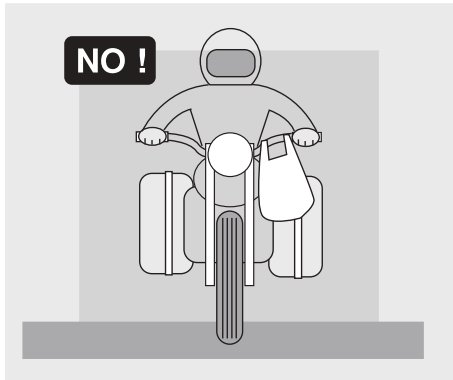

Avoid hanging bulky, heavy and/or dangerous objects on the handlebars, mudguards and forks, because the vehicle might respond more slowly in turns and its manoeuvrability could be unavoidably impaired.

Do not place bags that are too bulky on the vehicle sides and do not ride with the crash helmet hanging from its string, because it could hit people or obstacles making you lose control of the vehicle.

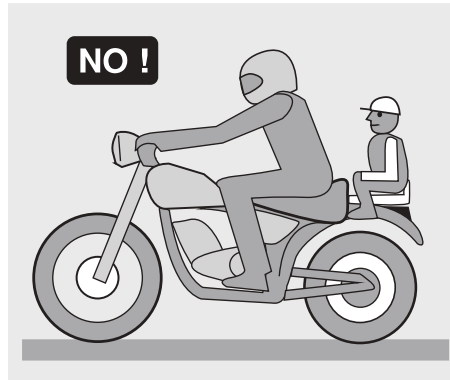

Do not carry any bag if it is not tightly secured to the vehicle.

Do not carry bags which protrude too much from the luggage rack or which cover the lights, horn or indicators.

Do not carry animals or children on the glove compartment or on the luggage rack.

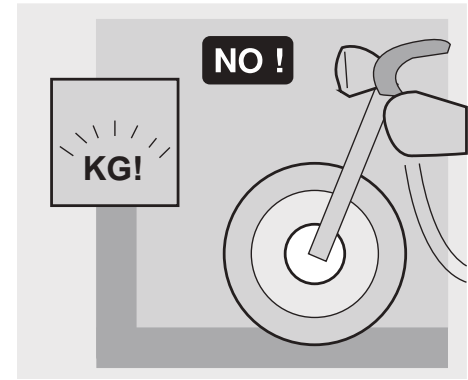

Do not exceed the maximum load allowed for each side-bag.

When the vehicle is overloaded, its stability and its manoeuvrability can be compromised.

ARRANGEMENT OF THE MAIN ELEMENTS

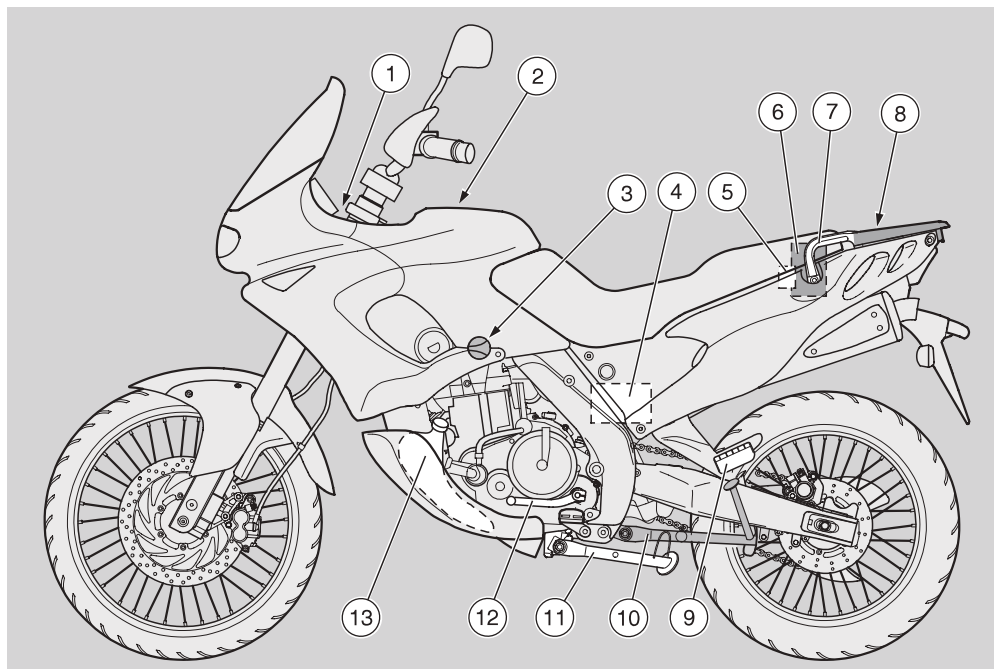

KEY

- | | |
|----------------------------------|------------------------------|
| 1) Ignition switch/steering lock | 8) Rear luggage rack |
| 2) Fuel tank plug | 9) Passenger footrest |
| 3) Fuel cock | 10) Central stand OPT |
| 4) Battery | 11) Side stand |
| 5) Fuses | 12) Shifting lever |
| 6) Glove/tool kit compartment | 13) Expansion tank |
| 7) Passenger grab rail | |

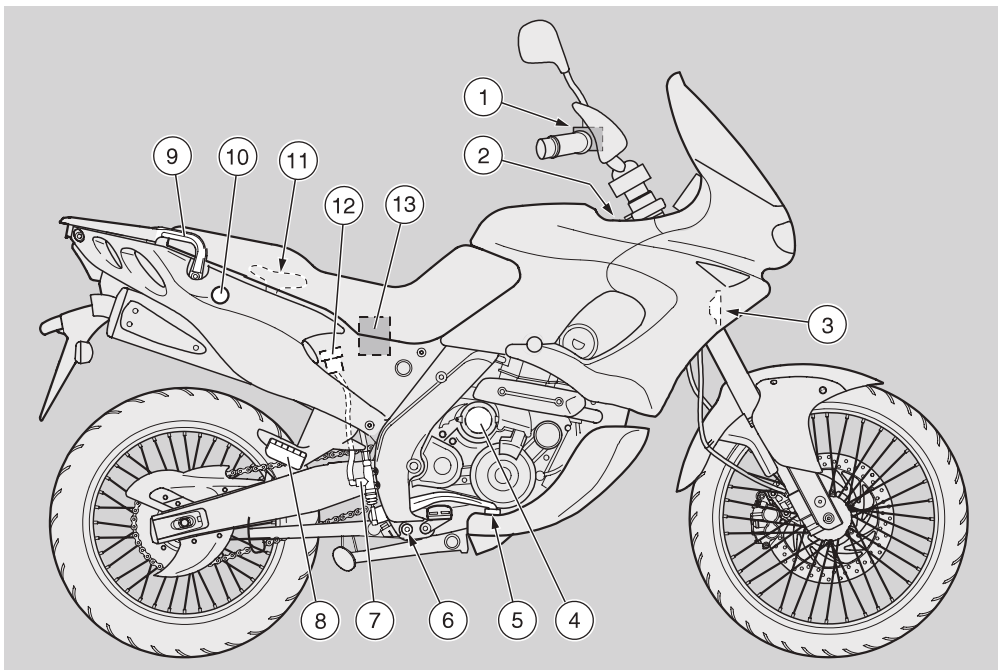

KEY

- | | |
|--|-------------------------------|
| 1) Front brake master cylinder | 7) Rear brake master cylinder |
| 2) Engine oil level plug-dipstick | 8) Passenger footrest |
| 3) Horn | 9) Passenger grab rail |
| 4) Engine oil filter | 10) Saddle lock |
| 5) Rear brake control lever | 11) Crash helmet hook |
| 6) Anti-theft hook (for the aprilia "Body-Guard" armored cable OPT) | 12) Rear brake fluid tank |
| | 13) Air cleaner |

ARRANGEMENT OF THE INSTRUMENTS

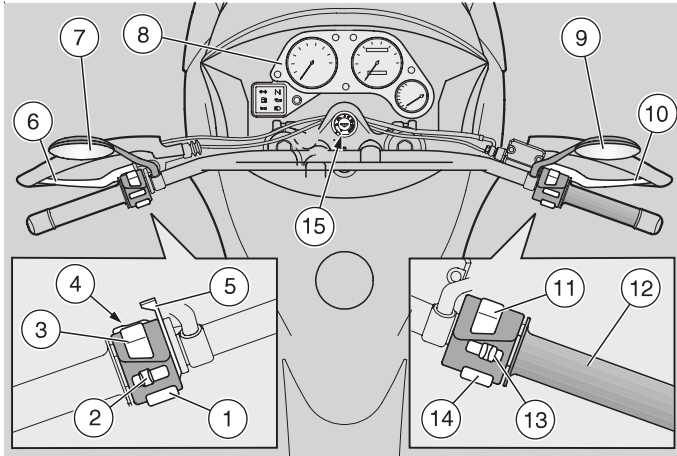

KEY

- 1) Horn push button (🔊)
- 2) Direction indicator switch (↔)
- 3) Dimmer switch (☞ - ☜)
- 4) High beam signalling push button (☞)
- 5) Cold start lever (| \)
- 6) Clutch lever
- 7) Left rear-view mirror
- 8) Instruments and indicators
- 9) Right rear-view mirror
- 10) Front brake lever
- 11) Engine stop switch (○ - ☒)
- 12) Throttle grip
- 13) Light switch (☞ - ☜ - ●)
- 14) Start push button (🔊)
- 15) Ignition switch/steering lock (○ - ☒ - 🔑)



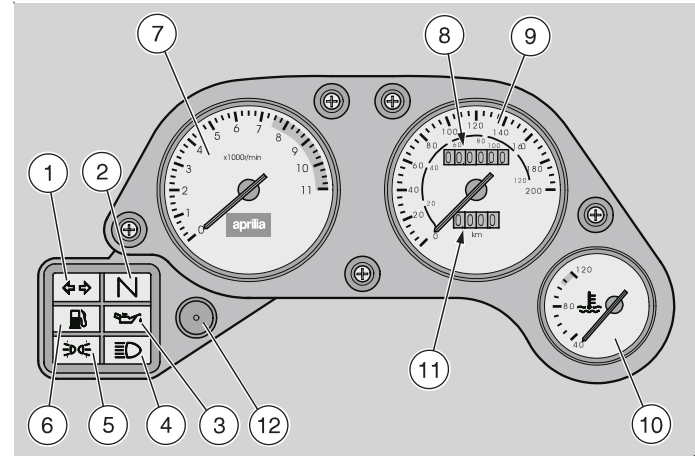







INSTRUMENTS AND INDICATORS



KEY

- 1) Green direction indicator warning light (↔)
- 2) Green neutral indicator warning light (N)
- 3) Red engine oil pressure warning light (🔴)
- 4) Blue high beam warning light (☞)
- 5) Green low beam and parking light warning light (☞)
- 6) Amber low fuel warning light (🔴)
- 7) Revolution counter
- 8) Total kilometres odometer
- 9) Speedometer
- 9) Speedometer - only km/h scale **AUS**
- 10) Coolant temperature indicator (🌡️)
- 11) Partial kilometres odometer
- 12) Odometer trip control



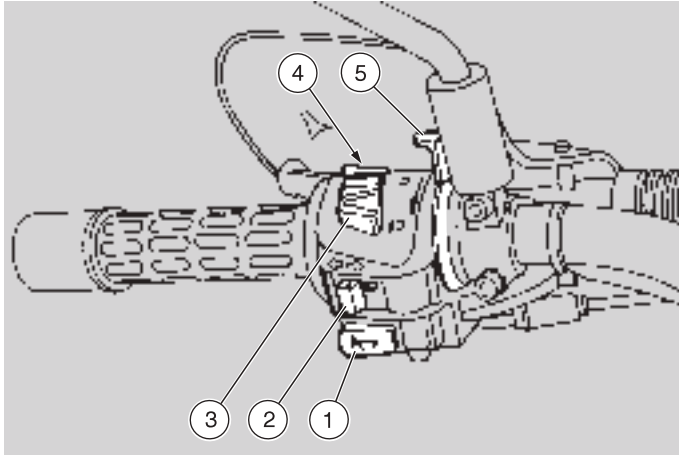

INSTRUMENTS AND INDICATORS TABLE

Description	Function
Direction indicator warning light 	It blinks when the direction indicators are on.
Neutral indicator warning light 	It comes on when the gear is in neutral.
Engine oil pressure warning light 	It comes on every time the ignition switch is brought to position "O" and the engine is not running, thus checking the proper functioning of the lamp. If during this phase the lamp does not turn on, it must be replaced. The warning light must go off when the engine is running.  If the warning light comes on during the normal running of the engine, this means that the oil pressure in the circuit is insufficient. In this case, immediately stop the engine and contact your aprilia Official Dealer.
High beam warning light 	It comes on when the headlight is in "high beam" position or when the high beam signalling is operated.
Parking light and low beam warning light 	It comes on when the lights are on.
Low fuel warning light 	It comes on when the quantity of fuel left in the tank is about 6 ℓ (electrical reserve). In this case, provide for immediate topping up, see p. 21 (FUEL).
Revolution counter	It indicates the number of revolutions of the engine per minute.  Never exceed the engine max. rpm, see p. 34 (RUNNING-IN).
Total kilometres odometer	It indicates the total number of kilometres covered.
Speedometer	It indicates the driving speed.
Coolant temperature indicator 	It indicates the approximate temperature of the coolant in the engine. When the pointer starts moving beyond level "40", the temperature is sufficient for driving the vehicle. The normal running temperature range is indicated by the graduated area of the scale. If the pointer reaches the red area, stop the engine and check the coolant level, see p. 26 (COOLANT).  If the maximum allowed temperature is exceeded (red area of the scale), the engine may be seriously damaged.
Partial kilometres odometer	It indicates the partial number of kilometres covered. To set it to zero, use the odometer trip control.
Odometer trip control	Rotate it anticlockwise to set the partial kilometres odometer to zero.



CONTROLS ON THE LEFT SIDE OF THE HANDLEBAR

 The electrical parts work only when the ignition switch is in position "O".

- 1) HORN PUSH BUTTON** 
The horn is activated when the push button is pressed.
- 2) DIRECTION INDICATOR SWITCH** 
To indicate the turn to the left, move the switch to the left; to indicate the turn to the right, move the switch to the right. To turn off the direction indicator, press the switch on its centre.
- 3) DIMMER SWITCH** 
When the light switch (right side of the handlebar) is in position "☉", if the dimmer switch is in position "☺", the high beam comes on, while if it is in position "☻", the low beam comes on.
- 4) HIGH BEAM SIGNALLING PUSH BUTTON** 
It makes it possible to use the high beam for signalling to forthcoming vehicles while overtaking and in case of peril and/or emergency.
- 5) COLD START LEVER** 
The starter for the cold start of the engine is operated by rotating the lever "⌞" downwards.
To disconnect the starter, move the lever "⌞" to its initial position.

CONTROLS ON THE RIGHT SIDE OF THE HANDLEBAR

 The electrical parts work only when the ignition switch is in position "○".

1) ENGINE STOP SWITCH (○ - ☒)

 **Do not operate the engine stop switch "○ - ☒" in running conditions.**

This is a safety or emergency switch. With the switch in position "○", it is possible to start the engine; the engine can be stopped by moving the switch to position "☒".

 **With stopped engine and ignition switch in position "○", the battery may discharge. When the vehicle has come to rest, after stopping the engine, move the ignition switch to position "☒".**

2) HEADLIGHT SWITCH (☀ - ☞☞ - ●)

When the light switch is in position "●", the lights are off; when the switch is in position "☞☞", the parking lights are on; when the switch is in position "☀", the low beam or the high beam is on.

The high/low beam can be operated by means of the dimmer switch, see p. 16 (CONTROLS ON THE LEFT SIDE OF THE HANDLEBAR).

3) START PUSH BUTTON (Ⓢ)

When the start push button "Ⓢ" is pressed, the starter makes the engine run. For the starting, see p. 30 (STARTING).

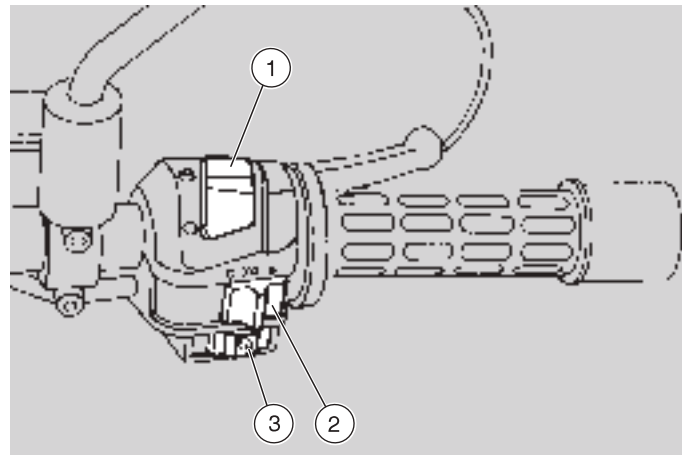

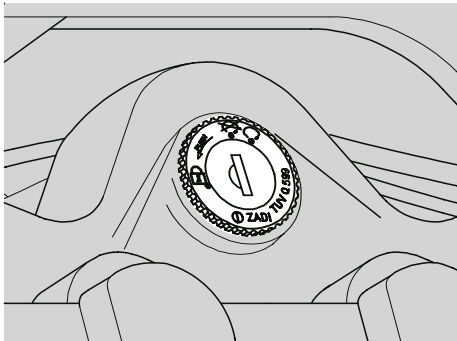

IGNITION SWITCH

The ignition switch is positioned on the steering column plate.

 **The key (1) operates the ignition switch/steering lock, the saddle lock and the fuel tank lock. Two keys are supplied together with the vehicle (one spare key).**

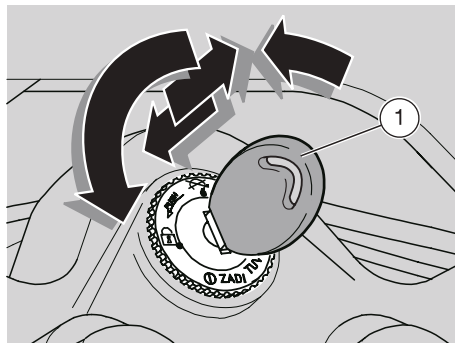

STEERING LOCK

Never turn the key to position "🔒" in running conditions, in order to avoid losing control of the vehicle.



OPERATION

To lock the steering:

- ◆ Turn the handlebar completely leftwards.
- ◆ Turn the key (1) to position "🔒" and press it.
- ◆ Release the key.

 **Turn the key and steer the handlebar at the same time.**

- ◆ Rotate the key (1) anticlockwise (leftwards), steer the handlebar slowly until the key (1) reaches position "🔒".
- ◆ Extract the key.

Position	Function	Key removal
 Steering lock	The steering is locked. It is neither possible to start the engine, nor to switch on the lights.	It is possible to remove the key.
	Neither the engine, nor the lights can be switched on.	It is possible to remove the key.
	The engine and the lights can be switched on.	It is not possible to remove the key.

AUXILIARY EQUIPMENT

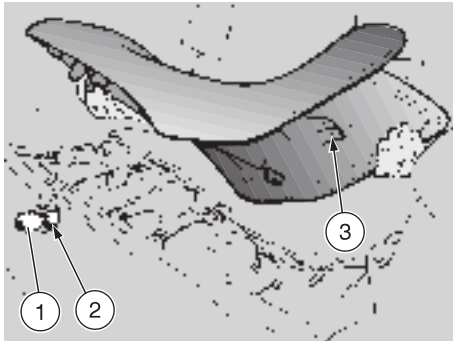

UNLOCKING/LOCKING THE SADDLE

- ◆ Position the vehicle on the stand, see p. 35 (POSITIONING THE VEHICLE ON THE STAND).
- ◆ Insert the key (1) in the saddle lock (2).
- ◆ Turn the key (1) clockwise and raise and remove the saddle.

 **Before lowering and locking the saddle, make sure that you have not left the key in the glove/tool kit compartment.**

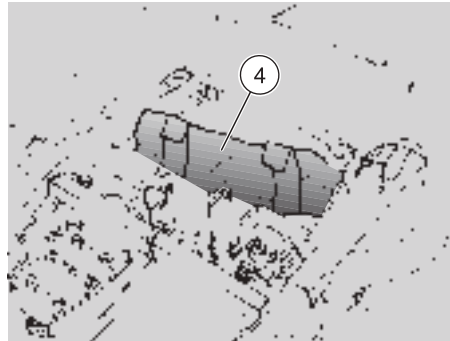

- ◆ To lock the saddle, position the tang (3) in its seat, then lower and press the saddle, thus making the lock snap shut.



Before leaving, make sure that the saddle is properly locked.

GLOVE/TOOL KIT COMPARTMENT

The compartment is positioned under the rear part of the saddle; to reach it:

- ◆ Unlock and raise the saddle.

The tool kit (4) includes:

- 3, 4, 5, 6, 8 mm Allen spanners
- 5,5-7 mm double fork spanner
- 8-11 mm double fork spanner
- 10-13 mm double fork spanner
- 19 mm simple fork spanner
- 24 mm simple fork spanner
- double-ended, cross-/cut-headed screwdriver
- screwdriver handle
- 18 mm spark plug socket spanner
- socket spanner rod
- tool case

Max. allowed weight: 1.5 kg

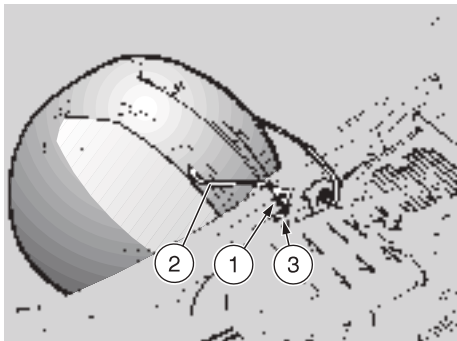

CRASH HELMET HOOK

Thanks to the crash helmet hook, you no longer have to carry the crash helmet with you every time you park the vehicle.



Do not ride with the crash helmet hanging from the hook, as this may seriously compromise your safety.

To hang the crash helmet:

- ◆ Raise the saddle.
- ◆ Withdraw the eyelet (1) of the cable (2) from the hook (3).
- ◆ Pass the cable (2) through the visor opening or through the apposite loop on the crash helmet.
- ◆ Insert the eyelet (1) completely in the hook (3).
- ◆ Lower the saddle and lock it.

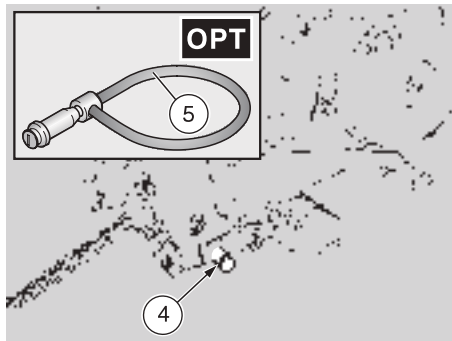

ANTI-THEFT HOOK

The anti-theft hook (4) is positioned on the right side of the vehicle, near the rider's footboard.

To prevent the vehicle from being stolen, it is advisable to secure it with the **aprilia** "Body-Guard" armored cable **OPT** (5), available at any **aprilia** Official Dealer.



Do not use the hook to lift the vehicle or for any purpose other than securing the vehicle once it has been parked.



REAR LUGGAGE RACK

Max. allowed weight: 9 kg

MAIN COMPONENTS

FUEL



The fuel used for internal combustion engines is extremely inflammable and in particular conditions it can become explosive. It is important to carry out the refuelling and the maintenance operations in a well-ventilated area, with the engine off. Do not smoke while refuelling or near fuel vapours, in any case avoid any contact with naked flames, sparks and any other heat source to prevent the fuel from catching fire or from exploding. Further, prevent fuel from flowing out of the fuel filler, as it could catch fire when getting in contact with the red-hot surfaces of the engine.

In case some fuel has accidentally been spilt, make sure that the area has completely dried and before starting the vehicle verify that there is no fuel inside the fuel filler neck.

Since petrol expands under the heat of the sun and due to the effects of sun radiation, never fill the tank to the brim. Screw the plug up carefully after refuelling. Avoid any contact of the fuel with the skin and the inhalation of vapours; do not swallow fuel or pour it from a receptacle into another by means of a tube.



KEEP AWAY FROM CHILDREN

Use only premium grade petrol (4 Stars **UK**), in conformity with the DIN 51600 standard, min. O.N. 98 (N.O.R.M.) and 88 (N.O.M.M.).

AUS: Use only unleaded petrol, in conformity with the DIN 51607 standard, min. O.N. 95 (N.O.R.M.) and 85 (N.O.M.M.).

FUEL TANK CAPACITY
(reserve included): 22 ℓ

TANK RESERVE:
5 ℓ (mechanical reserve).

To refuel, proceed as follows:

- ◆ Insert the key (1) in the tank plug lock(2).
- ◆ Turn the key clockwise, pull and open the fuel flap.

ENGINE OIL



Remember:
1 miles = 1.6 km
1 km = 0.625 miles

Check the engine oil level every 500 km, see p. 39 (CHECKING THE ENGINE OIL LEVEL AND TOPPING UP).

It is necessary to change the engine oil after the first 1000 km and successively every 6000 km, see p. 40 (CHANGING THE ENGINE OIL AND THE OIL FILTER).



Use high-quality 5W-40 oil, see p. 68 (LUBRICANT TABLE).



Engine oil can cause serious damage to the skin if handled every day and for long periods. Wash your hands carefully after using the oil.

Do not dispose of the oil in the environment.

Put it in a sealed container and take it to the filling station where you usually buy it or to an oil salvage center.



BRAKE FLUID (recommendations)

 This vehicle is provided with front and rear disc brakes, with separate hydraulic circuits. The following information refers to a single braking system, but is valid for both.

 Sudden resistance or clearance problems on the brake lever may be due to troubles in the hydraulic system. For any doubt regarding the perfect functioning of the braking system and in case you are not able to carry out the usual checking operations, contact your **aprilia** Official Dealer.

 Make sure that the brake disc is neither oily nor greasy, especially after maintenance or checking operations. Check that the brake cable is neither twisted nor worn out. Prevent water or dust from accidentally getting into the circuit.

In case maintenance operations are to be performed on the hydraulic circuit, it is advisable to use latex gloves.

If the brake fluid gets in contact with the skin or the eyes, it can cause serious irritations.

Carefully wash the parts of your body that get in contact with the liquid. Consult a doctor or an oculist if the liquid gets in contact with your eyes.

Do not dispose of the brake fluid in the environment.

KEEP AWAY FROM CHILDREN

 When using the brake fluid, take care not to spill it on the plastic or painted parts, since it can damage them.

DISC BRAKES

 The brakes are the parts that most ensure your safety and for this reason they must always be perfectly working.

The brake fluid must be changed once a year by an **aprilia** Official Dealer.

This vehicle is provided with front and rear hydraulic disc brakes. When the disc pads wear out, the level of the fluid decreases to automatically compensate for their wear.

The front brake fluid tank is positioned on the handlebar, near the front brake lever coupling.

The rear brake fluid tank is positioned under the right side; to reach it, remove the right side, see p. 48 (REMOVING THE RIGHT AND LEFT SIDES).

Periodically check the brake fluid level in the tanks, see p. 23 (FRONT BRAKE) and the wear of the pads, see p. 51 (CHECKING THE BRAKE PAD WEAR).

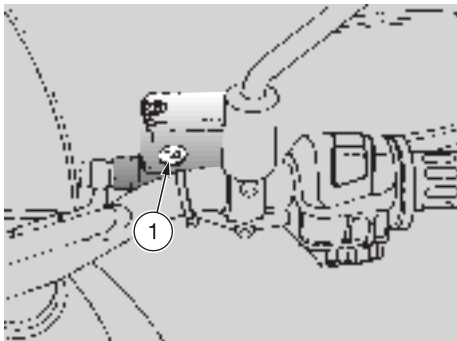

FRONT BRAKE

Checking



Position the vehicle on firm and flat ground.

- ◆ Keep the vehicle in vertical position and rotate the handlebar, so that the fluid contained in the tank is parallel to the brake fluid tank cover.
- ◆ Make sure that the fluid level exceeds the "MIN" mark.
- ◆ If the fluid does not reach the "MIN" mark, provide for topping up.

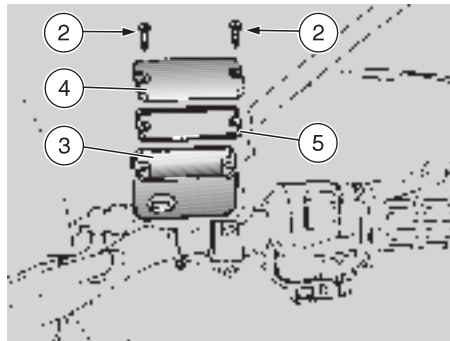

Topping up:



The brake fluid may flow out of the tank. Do not operate the front brake lever if the screws (2) are loose or, most important, if the brake fluid tank cover has been removed.

- ◆ Unscrew the two screws (2) of the brake fluid tank (3).
- ◆ Remove the cover (4).



In order not to spill the brake fluid while topping up, keep the fluid in the tank parallel to the tank rim (in horizontal position).

- ◆ Remove the gasket (5).
- ◆ Fill the tank (3) with brake fluid, see p. 68 (LUBRICANT TABLE), until it covers the glass (1) completely.



- ◆ To reassemble the components, follow the reverse order.



Check the braking efficiency. If necessary, contact your **aprilia** Official Dealer.

In case of excessive stroke of the brake lever, of excessive elasticity or in case there is air in the circuit, contact your **aprilia** Official Dealer, since it may be necessary to bleed the system.

In any case, the bleeding must be carried out after the first 1000 km.



Remember:

1 miles = 1.6 km

1 km = 0.625 miles

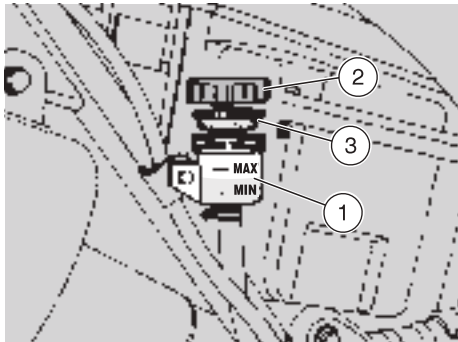

⚠ The brake fluid may flow out of the tank. Do not operate the rear brake lever if the brake fluid tank plug is loose or has been removed.

◆ Unscrew and remove the plug (2).

☞ In order not to spill the brake fluid while topping up, keep the fluid in the tank parallel to the tank rim (in horizontal position).

- ◆ Remove the gasket (3).
- ◆ Fill the tank (1) with brake fluid, see p. 68 (LUBRICANT TABLE), until it reaches the "MAX" mark.
- ◆ To reassemble the components, follow the reverse order.

⚠ Check the braking efficiency. If necessary, contact your **aprilia Official Dealer**.

In case of excessive stroke of the brake lever, of excessive elasticity or in case there is air in the circuit, contact your aprilia Official Dealer, since it may be necessary to bleed the system.

In any case, the bleeding must be carried out after the first 1000 km.

☞ Remember:
 1 miles = 1.6 km
 1 km = 0.625 miles

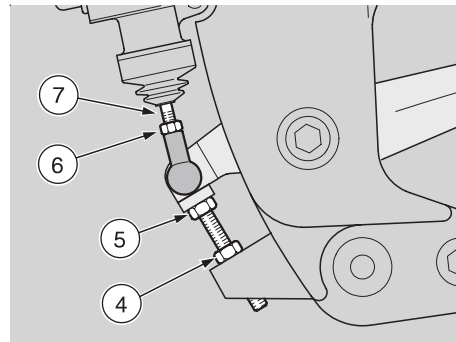

ADJUSTING THE REAR BRAKE

The brake pedal is positioned ergonomically during the assembly of the vehicle. If necessary, it is possible to adjust the height of the brake pedal:

- ◆ Loosen the lock nut (4).
- ◆ Screw the brake adjuster (5) completely.
- ◆ Screw the lock nut (6) completely on the pump control rod (7).
- ◆ Screw the pump control rod (7) completely, then unscrew it by giving 3-4 turns.
- ◆ Unscrew the brake adjuster (5) until the brake pedal reaches the desired height.
- ◆ Lock the brake adjuster (5) by means of the lock nut (4).
- ◆ Unscrew the pump control rod (7) and bring it in contact with the pump piston.
- ◆ Screw the rod in order to ensure a minimum clearance of 0.5÷1 mm between the pump control rod (7) and the pump piston.

REAR BRAKE

Checking

☞ Position the vehicle on firm and flat ground.

- ◆ Keep the vehicle in vertical position, so that the fluid contained in the tank (1) is parallel to the plug (2).
- ◆ Make sure that the fluid level exceeds the "MIN" mark.
- ◆ If the fluid does not reach the "MIN" mark, provide for topping up.

Topping up:

- ◆ Remove the right side, see p. 48 (REMOVING THE RIGHT AND LEFT SIDES).



Make sure that there is a certain clearance between the brake adjuster (5) and the point of contact, to prevent the brake from remaining operated and the consequent untimely wear of the braking elements.

Clearance between brake adjuster and point of contact: $0.5 \div 1$ mm.

- ◆ Lock the pump control rod by means of the lock nut (6).



Check the braking efficiency.
If necessary, contact an **aprilia** Official Dealer.

After the adjustment, make sure that the wheel rotates freely with released brake.

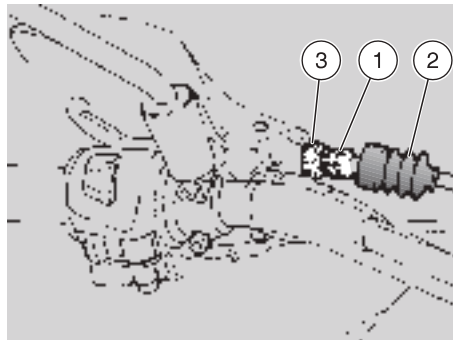

CLUTCH

ADJUSTING THE CLUTCH



Remember:
1 miles = 1.6 km
1 km = 0.625 miles

Adjust the clutch every 6000 km and if the engine stops or tends to advance when the clutch lever is pulled and the gears are engaged, or if the clutch slips causing a delay in the acceleration in comparison with the engine speed.

Carry out the adjustment by means of the adjuster (1).

- ◆ Withdraw the protection element (2).
- ◆ Loosen the lock nut (3).
- ◆ Rotate the adjuster (1) until the idle stroke of the clutch lever is about 10 mm.
- ◆ Tighten the lock nut (3) and check the adjustment again.

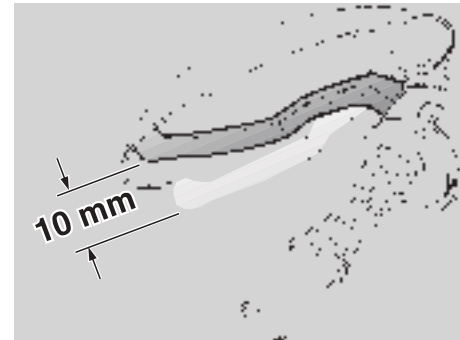

- ◆ Start the engine, see p. 30 (STARTING).
- ◆ Operate the clutch completely and engage the 1st gear.

Make sure that the engine does not stop, that the vehicle does not tend to advance or that the clutch does not slip during the acceleration phase or while the vehicle is running.



If it is not possible to obtain a correct adjustment or if the clutch does not function properly, contact your **aprilia** Official Dealer.



Make sure that the clutch cable is intact: it must not present flattened parts and the sheath must not be worn out in any point.

COOLANT



Do not use the vehicle if the coolant is below the minimum prescribed level.



Remember:
1 miles = 1.6 km
1 km = 0.625 miles

Check the coolant level every 1000 km and after long rides; change it every 2 years.



Have the coolant changed by an Aprilia Official Dealer.

The coolant is made up of 50% water and 50% antifreeze. This mixture is ideal for most running temperatures and ensures good protection against corrosion.

It is advisable to keep the same mixture also in the hot season, since in this way losses due to evaporation are reduced and it is not necessary to top up very frequently.

The mineral salt deposits left in the radiator by evaporated water are thus reduced and the efficiency of the cooling system remains unchanged.

If the outdoor temperature is below 0°, check the cooling circuit frequently and if necessary increase the antifreeze concentration (up to maximum 60%).

For the cooling solution use distilled water, in order not to damage the engine.

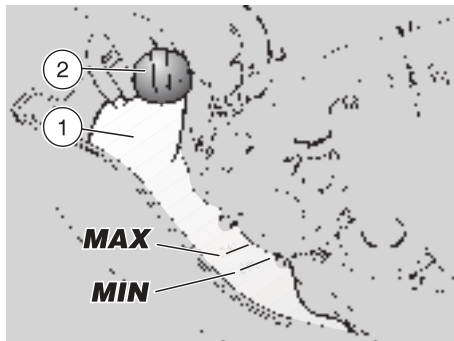

Do not remove the expansion tank cap when the engine is hot, since the coolant is under pressure and its temperature is high. If it gets in contact with the skin or with clothes it may cause severe burns and/or damages.

The coolant is noxious:

DO NOT SWALLOW IT

KEEP AWAY FROM CHILDREN

Checking and topping up



Check the coolant level and top up the expansion tank with cold engine.

◆ Stop the engine and wait until it has cooled down.



Position the vehicle on firm and flat ground.

◆ Keep the vehicle in vertical position, with the two wheels resting on the ground.

◆ Make sure that the level of the fluid contained in the expansion tank (1) is included between the "MIN" and "MAX" marks (see figure).

◆ If not, unscrew and remove the filling plug (2).

◆ Top up until the fluid reaches approx. the "MAX" mark. Do not exceed this level, otherwise the fluid will flow out of the tank when the engine is running.

◆ Put back the filling plug (2).



In case of excessive consumption of coolant and in case the expansion tank (1) remains empty, make sure that there are no leaks in the circuit. Have it repaired by an Aprilia Official Dealer.



TYRES

This vehicle is provided with tyres with inner tube.



Periodically check the tyre inflation pressure at room temperature.

If the tyres are hot, the measurement is not correct.

Carry out the measurement especially before and after long rides.

If the inflation pressure is too high, the ground unevenness cannot be dampened and is therefore transmitted to the handlebar, thus compromising the driving comfort and reducing the road holding during turns.

If, on the contrary, the inflation pressure is too low, the tyre sides are under greater stress and the tyre itself may slip on the rim or it may become loose, with consequent loss of control of the vehicle. In case of sudden braking the tyres could even get out of the rims. Further, the vehicle could skid while turning.

Check the surface and the wear of the tyres, since tyres in bad conditions can impair both the grip and the controllability of the vehicle.

Change the tyre when it is worn out or in case of puncture on the tread side, if the puncture is larger than 5 mm. After repairing a tyre, have the wheels balanced. Use only tyres in the size suggested by aprilia, see p. 65 (TECHNICAL DATA).

Make sure that the tyres always have their valve sealing caps on, to prevent them from suddenly going flat. Change, repair, maintenance and balancing operations are very important and should be carried out by qualified technicians with appropriate tools.

For this reason, it is advisable to have the above mentioned operations carried out by an **aprilia** Official Dealer or by a qualified tyre repairer.

If the tyres are new, they may still be covered with a slippery film: drive carefully for the first miles. Do not oil the tyres with unsuitable fluids.

If the tyres are old, even if not completely worn out, they may become hard and may not ensure good road holding. In this case, replace them.

INFLATION PRESSURE

SOLO RIDER

front:

off-road 180 kPa (1.8 bar)

asphalted road 180 kPa (1.8 bar)

rear:

off-road 190 kPa (1.9 bar)

asphalted road 190 kPa (1.9 bar)

RIDER AND PASSENGER

front:

off-road 180 kPa (1.8 bar)

asphalted road 180 kPa (1.8 bar)

rear:

off-road 190 kPa (1.9 bar)

asphalted road 220 kPa (2.2 bar)

MINIMUM TREAD DEPTH LIMIT

front: 2 mm

rear: 2 mm

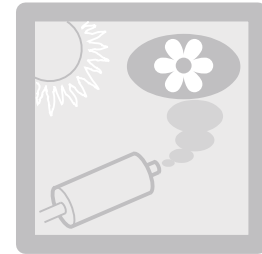

EXHAUST SILENCERS

Tampering with noise control system prohibited.

Owner's are warned that the law may prohibit:

- ◆ The removal or rendering inoperative by any person other than for purposes of maintenance, repair or replacement, of any device or element of design incorporated into any new vehicle for the purpose of noise control prior to its sale or delivery to the ultimate purchaser or while it is in use; and
- ◆ the use of the vehicle after such device or element of design has been removed or rendered inoperative by any person.

Check the exhaust silencer and the silencer pipes, making sure that there are neither signs of rust, nor holes and that the exhaust system can work effectively.

If the noise produced by the exhaust system increases, immediately contact your **aprilia** Official Dealer.

CATALYTIC SILENCERS

 **Avoid parking the vehicle-catalytic version near dry brush wood or in places easily accessible to children, as the catalytic silencers becomes extremely hot during use; be very careful and avoid any kind of contact before they are completely cooled down.**

The catalytic vehicle is fitted with a silencer with metal catalytic converter of the "platinum-rhodium bivalent" type. This device provides for the oxidation of the CO (carbon monoxide) and of the HC (unburned hydrocarbons) contained in the exhaust gases, changing them into carbon dioxide and steam, respectively.

 **Do not use leaded petrol, since it causes the destruction of the catalytic converter.**

INSTRUCTIONS FOR USE



Before departure, always carry out a preliminary checking of the vehicle to make sure that it functions correctly and safely, see the following table (PRELIMINARY CHECKING OPERATIONS). The non-performance of these checking operations can cause severe personal injuries or damages to the vehicle.

Do not hesitate to consult your **aprilia** Official Dealer in case there is something you do not understand about the functioning of some controls or in case you suspect or discover some irregularities.

It does not take long to carry out a check-up and this operation ensures you much more safety.

PRELIMINARY CHECKING OPERATIONS

Component	Check	Page
Front and rear disc brakes	Check the functioning, the idle stroke of the control levers, the fluid level and make sure there are no leaks. Check the wear of the pads. If necessary, top up the fluid tank.	22-23 24-51
Accelerator	Make sure that it works smoothly and that it is possible to open and close it completely, in all steering positions. If necessary, adjust and/or lubricate it.	52
Engine oil	Check and/or top up if necessary.	21-39-40
Wheel/tyres	Check the tyre surface, the inflation pressure, wear and tear and any damage.	27
Brake levers	Make sure that they work smoothly. If necessary, lubricate the articulations and adjust the stroke.	22-23-24
Steering	Make sure that the steering rotates smoothly, without any clearance or slackening.	49
Clutch	The idle stroke at the end of the clutch lever must be about 10 mm; the clutch must operate without jerking and/or slipping.	25
Side stand and center stand OPT	Make sure that it works smoothly and that the spring tension brings it back to its normal position. If necessary, lubricate joints and hinges. Make sure that the safety switch on the side stand operates correctly.	57
Fastening elements	Make sure that the fastening elements are not loose. If necessary, adjust or tighten them.	–
Drive chain	Check the slack.	46-47
Fuel tank	Check the fuel level and top up, if necessary. Make sure there are no leaks or air bubbles in the circuit.	21-48-62
Coolant	The coolant level in the expansion tank must be included between the " MIN " and " MAX " marks.	26
Lights, warning lights, horn and electric devices	Check the proper functioning of the acoustic and visual devices. Change the bulbs or intervene in case of failure.	54-61

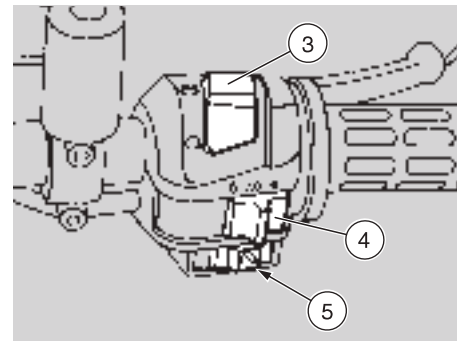
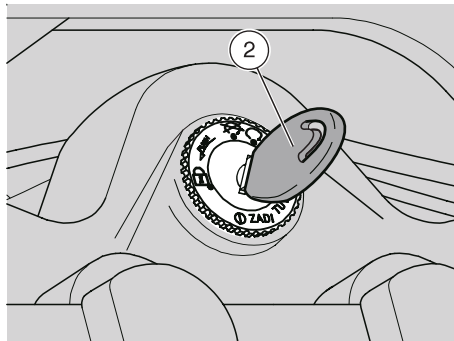
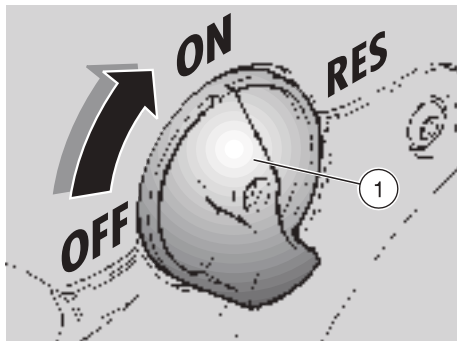

STARTING



 Exhaust gases contain carbon monoxide, which is extremely noxious if inhaled.



Avoid starting the engine in closed or badly-ventilated rooms.

The non-observance of this warning may cause loss of consciousness or even lead to death by asphyxia.



 With the side stand down, the engine can be started only if the gears are in neutral; in this case, if you try to engage the gears, the engine stops.

With the side stand up, it is possible to start the engine either in neutral gear or with engaged gears and pulled clutch lever.



- ◆ Let the stand up.
- ◆ Get on the vehicle.
- ◆ Move the fuel tap lever (1) to position "ON".
- ◆ Rotate the key (2) and move the ignition switch to position "O".
At this point the engine oil pressure warning light "" must come on.
- ◆ Lock at least one wheel, by pulling a brake lever.
- ◆ Position the shifting lever in neutral (green warning light "" on).
- ◆ Move the engine stop switch (3) to position "O".
- ◆ Make sure that the light switch (4) is in position "•".

 To avoid excessive wear on the battery, do not keep the start push button "" pressed for more than fifteen seconds. If the engine does not start in this lapse of time, wait ten seconds and then press the start push button "" again.

- ◆ Press the start push button "" (5) without accelerating, then release it as soon as the engine starts.

 As soon as the engine has started, the engine oil pressure warning light "" must go out. If this does not occur, or if the warning light comes on while the engine is running, this means that there is no sufficient pressure in the circuit. In this case, stop the engine immediately and contact an **aprilia Official Dealer**.

- ◆ If the vehicle is started with cold engine, rotate the cold start lever "" (6) downwards.

 Never press the start push button "" (5) with the engine running: you may damage the starter.

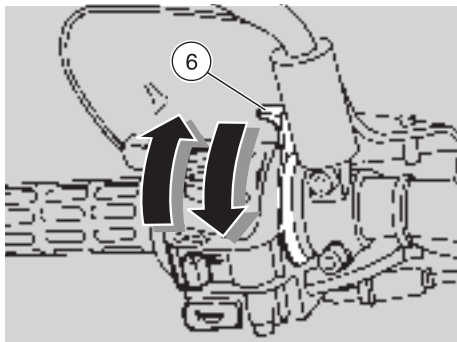

- ◆ Keep at least one brake lever pulled and do not accelerate until you start.



Never leave abruptly with cold engine.

To reduce the emission of polluting substances and the consumption of fuel, warm the engine up by proceeding at low speed for the first miles.

- ◆ Ride at reduced speed for the first miles, in order to warm the engine up.
- ◆ Rotate the cold start lever "↕" (6) upwards after the engine has warmed up.

Starting with flooded engine

If the starting is not carried out properly or if there is too much fuel in the intake ducts and in the carburettor, the engine may get flooded.

To clean a flooded engine:

- ◆ Carry out the first eight operations described for the starting.
- ◆ Rotate the cold start lever "↕" (6) upwards.
- ◆ Press the start push button "Ⓢ" (5) for a few seconds (letting the engine spin over) with completely open throttle (**Pos. B**).

Starting with cold engine

When the room temperature is low (about 0° C), it may be difficult to start the engine at the first attempt.

In this case:

- ◆ Rotate the cold start lever "↕" (6) downwards.
- ◆ Press the start button "Ⓢ" (5) for at least ten seconds and at the same time rotate the throttle grip slightly.

If the engine starts

- ◆ Release the start push button "Ⓢ" (5) and the throttle grip.
- ◆ Rotate the cold start lever "↕" (6) upwards.

If the idling is unstable, twist the throttle grip slightly and frequently.

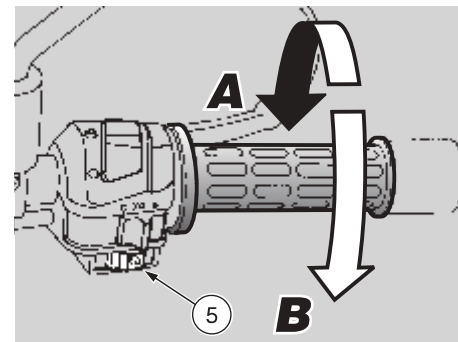

If the engine does not start

Wait for a few seconds and then repeat the starting procedure.

STARTING AFTER A LONG PERIOD OF INACTIVITY

After a long period of inactivity, make the starter run for about ten seconds without accelerating, in order to ensure the filling of the float chamber. To start the engine, slightly open the throttle and carry out the starting procedure.

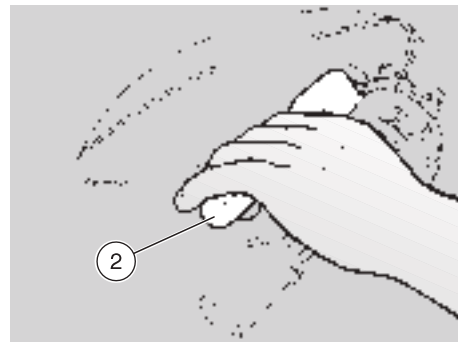
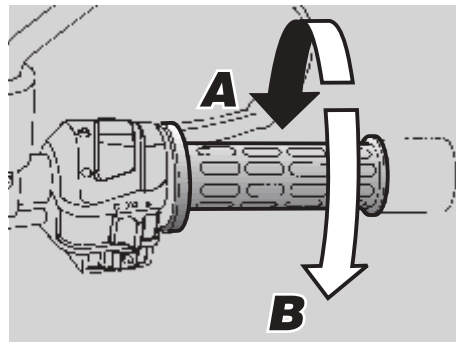
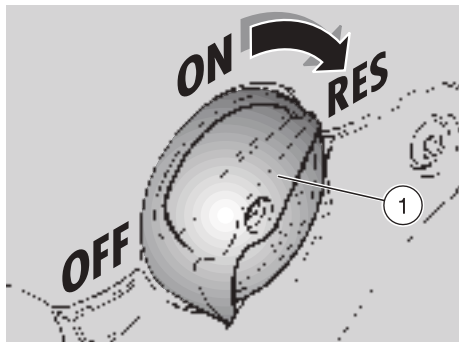



DEPARTURE AND DRIVE

 Before departure, carefully read the "RIDING SAFELY" chapter, see p. 5 (RIDING SAFELY).

If you run out of the "standard" fuel quantity while riding, move the fuel tap lever (1) to position "RES", in order to use the fuel reserve.

Fuel reserve: 5 ℓ (mechanical reserve).

 Immediately provide for topping up, see p. 21 (FUEL).

 Properly adjust the inclination of the rear-view mirrors. If you drive without passenger, make sure that the rear foot rests are closed.

 If you drive with a passenger, instruct him/her so that he/she does not create problems during manouvers. Before leaving, make sure that the stands are completely folded.

To leave:

- ◆ Ride at reduced speed for the first miles, in order to warm the engine up.
- ◆ With released throttle grip (**Pos. A**) and engine idling, pull the clutch lever (2) completely.
- ◆ Engage the first gear, by pressing the shifting lever (3) downwards.
- ◆ Release the brake lever (pulled on the starting).

 On departure, the abrupt release of the clutch lever may cause the engine to stall or the vehicle to jerk forwards.

 Never accelerate abruptly or excessively when releasing the clutch lever, in order to prevent the clutch from "slipping" (slow release) or the front wheel from raising (rearing up) (quick release).

- ◆ Slowly release the clutch lever (2) and at the same time accelerate by rotating the throttle grip moderately (**Pos. B**). The vehicle will start moving.

 Never exceed the recommended rpm, see p. 34 (RUNNING-IN).

- ◆ Increase the speed by gradually rotating the throttle grip (**Pos. B**), without exceeding the recommended rpm, see p. 34 (RUNNING-IN).

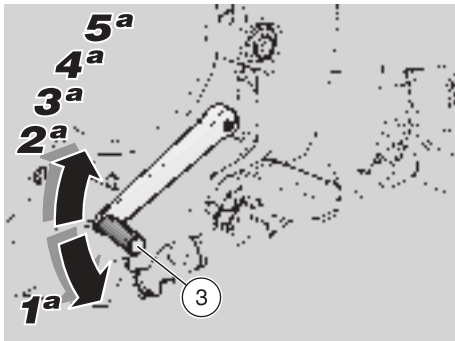

To engage the second gear:



Proceed quickly.
Never ride the vehicle at too low rpm.

- ◆ Release the throttle grip (Pos. A), pull the clutch lever (2) and lift the shifting lever (3). Release the clutch lever (2) and accelerate.
- ◆ Repeat the last two operations and shift up.

The downshifting should be carried out in the following situations:

- ◆ When riding downhill or when braking, in order to increase the braking action by using the compression of the engine.
- ◆ When riding uphill, if the gear engaged is not suitable to the speed (high gear, moderate speed) and the engine rpm decreases.



Shift the gears one by one; the simultaneous downshifting of more than one gear may make you exceed the maximum rpm (red line).

Before and during the downshifting, release the throttle grip and decelerate, in order to avoid the "red line".

To shift down, proceed as follows:

- ◆ Release the throttle grip (Pos. A).
- ◆ If necessary, pull the brake levers moderately and decrease the speed of the vehicle.
- ◆ Pull the clutch lever (2) and lower the shifting lever (3) to shift down.
- ◆ If the brake levers are pulled, release them.
- ◆ Release the clutch lever and accelerate moderately.



Avoid opening and closing the throttle grip repeatedly and continuously, so that you do not accidentally lose control of the vehicle.
If you have to brake, close the throttle and put on both brakes in order to obtain uniform deceleration, properly exerting pressure on the braking parts.

By putting on the front brake only or the rear brake only, you reduce the braking force considerably, thus running the risk of locking one wheel and consequently losing grip.

If you stop uphill, decelerate completely and use the brakes only to keep the vehicle steady.

The use of the engine to keep the vehicle steady may cause the overheating of the clutch.



Before beginning to turn, slow down or brake driving at moderate and constant speed or accelerating slightly; avoid braking at the last moment: it would be very easy to skid.

If the brakes are operated continuously on downhill stretches, the friction surfaces may overheat, thus reducing the braking efficiency. Exploit the engine compression and shift down by putting on both brakes intermittently. Never drive downhill with the engine off!

When visibility is insufficient, switch on the low beam even during the day, in order to make your vehicle more visible. In case of wet ground or scarce wheel grip (snow, ice, mud, etc.), drive slowly, avoiding sudden brakings or manoeuvres that could make you lose grip and fall down.



Pay the utmost attention to any obstacle or variation of the ground. Uneven roads, rails, manhole covers, indications painted on the road surface, building site metal plates become rather slippery by rain. For this reason all these obstacles have to be carefully avoided, driving smoothly and bending the vehicle as little as possible. Always use the turn indicators in time when you intend to change lane or direction, avoiding sharp and dangerous movements.

Switch off the direction indicators as soon as you have changed direction.

Be extremely careful when you overtake other vehicles or are overtaken.

In case of rain, the water cloud created by big vehicles reduces visibility; the air shift may make you lose control of the vehicle.

RUNNING-IN

The running-in of the engine is important to ensure its correct functioning.

If possible, drive on hilly roads and/or roads with many bends, so that the engine, the suspensions and the brakes undergo a more effective running-in.

Keep to the following indications:

- ◆ Do not open the throttle completely if the speed is low, both during and after the running-in.



Remember:

1 miles = 1.6 km

1 km = 0.625 miles

- ◆ During the first 100 km put on the brakes with caution, avoiding sharp and prolonged brakings. This ensures a correct bedding-in of the pads on the brake disc.
- ◆ During the first 500 km, never exceed 4000 rpm.
- ◆ Between the first 500 and 1000 km, never exceed 5000 rpm.



After the first 1000 km, carry out the checking operations indicated in the column "After running-in" of the **REGULAR SERVICE INTERVALS CHART**, see p. 36 (**REGULAR SERVICE INTERVALS CHART**), in order to avoid hurting yourself or other people and/or damaging the vehicle.

- ◆ Between the first 1000 and 2000 km drive more briskly, change speed and use the maximum acceleration only for a few seconds, in order to ensure better coupling of the components; never exceed 5500 rpm.
- ◆ After the first 2000 km you can expect better performance from the engine, however, without exceeding the max rpm (6250 rpm).

Engine maximum rpm for the running-in	
Mileage km	Max. rpm
0 - 500	4000
500 - 1000	5000
1000 - 2000	5500
over 2000	6250

STOPPING



If possible, avoid stopping abruptly, slowing down suddenly and braking at the last moment.

- ◆ Release the throttle grip, gradually put on the brakes and at the same time shift down in order to decrease the speed, see p. 32 (**DEPARTURE AND DRIVE**).

Once the speed has decreased, before stopping the vehicle:

- ◆ Pull the clutch lever in order to prevent the stopping of the engine.

When the vehicle has come to rest:

- ◆ Position the shifting lever in neutral (green warning light "N" on).
- ◆ Release the clutch lever.
- ◆ While the vehicle is at rest, keep at least one brake on.

PARKING



Park the vehicle on firm and flat ground, to prevent it from falling down.

Neither lean the vehicle against walls, nor lay it on the ground.

Make sure that the vehicle and especially its red-hot parts do not represent a danger for persons and children. Do not leave the vehicle unattended when the engine is on or the key is inserted into the ignition switch.

Do not sit on the vehicle when the stand is down.

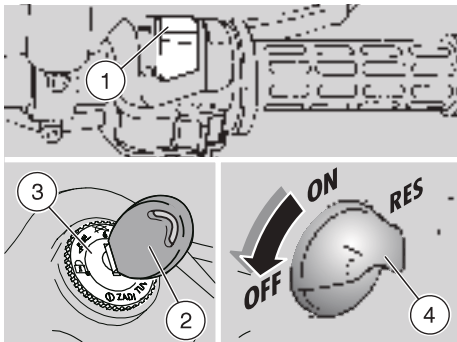

- ◆ Stop the vehicle, see p. 34 (STOPPING).
- ◆ Move the engine stop switch (1) to position "⊗".
- ◆ Rotate the key (2) and move the ignition switch (3) to position "⊗".
- ◆ Position the vehicle on the stand, see beside (POSITIONING THE VEHICLE ON THE STAND).
- ◆ Move the fuel tap lever (4) to position "OFF".



Never leave the key in the ignition switch.

- ◆ Lock the steering, see p. 18 (STEERING LOCK) and extract the key (2).

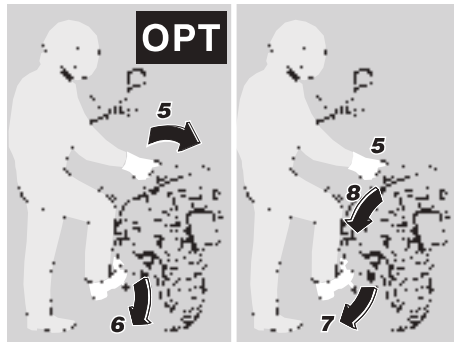

POSITIONING THE VEHICLE ON THE STAND

CENTRAL STAND **OPT**

- ◆ Seize the left grip and the left passenger grab rail (5).
- ◆ Press the stand lever (6) downwards.

SIDE STAND

- ◆ Seize the left grip and the left passenger grab rail (5).
- ◆ Press the side stand with your right foot and extend it completely (7).
- ◆ Incline the vehicle until the stand rests on the ground (8).
- ◆ Steer the handlebar completely leftwards.



Make sure that the vehicle is stable.

SUGGESTIONS TO PREVENT THEFT

NEVER leave the ignition key inserted and always use the steering lock.

Park the vehicle in a safe place, possibly in a garage or a protected place.

If possible, use the appropriate **aprilia** "Body-Guard" armored cable **OPT**, or an additional anti-theft device.

Make sure that all documents are in order and the road tax has been paid.

Write down your personal data and telephone number in this page, to facilitate the identification of the owner in case of finding after theft.

SURNAME:

NAME:

ADDRESS:

.....

TELEPHONE NO.:



Very often stolen vehicles are identified thanks to the data written in the use/maintenance manual.

MAINTENANCE



Before beginning any maintenance operation or any inspection of the vehicle, stop the engine, extract the key from the ignition block, wait until the engine and the exhaust system have cooled down and if possible lift the vehicle by means of the proper equipment, on firm and flat ground. Keep away from the red-hot parts of the engine and of the exhaust system, in order to avoid burns. The vehicle is made up of not edible parts. Never bite, suck, chew or swallow any part of the vehicle for any reason.



If not expressly indicated otherwise, for the reassembly of the units repeat the disassembly operations in reverse order.

Ordinary maintenance operations can usually be carried out by the user, but sometimes a basic knowledge of mechanics and specific tools are required. If you need assistance or technical advice, consult your **aprilia** Official Dealer, who can ensure you prompt and accurate servicing. After any maintenance operation, carry out the "Preliminary checking operations", see p. 29 (PRELIMINARY CHECKING OPERATIONS).



Remember:

1 miles = 1.6 km
1 km = 0.625 miles

REGULAR SERVICE INTERVALS CHART

Component	After running-in (1000 km)	Every 6000 km or 8 months	Every 12000 km or 16 months
Battery - electrolyte level	①	①	
Spark plug		①	③
Carburetors	①	②	
Drive chain		every 500 km: ①	
Timing chain		①	
Wheel centering		①	
Steering bearings and steering	①	①	
Wheel bearings		①	
Air cleaner		①	③
Engine oil filter	③	③	
Engine oil filter (on the frame)			②
Clutch clearance	④	④	
Tappet clearance	①	①	
Braking systems	①	①	
Cooling system	①	①	
Light system	①	①	
Brake fluid	①	every year: ③	
Brake fluid		①	
Coolant		every 1000 km:①/every 2 years:③	
Fork oil			③
Engine oil	③	every 500 km:①/every 6000 km:③	
Tyre pressure		④	every month: ④
Engine idling rpm	④	④	
Fuel cock	①	①	
Nut, bolt, screw tightening	①	①	
Suspensions and attitude	①		①
Brake fluid bleeding	①		
Spoke tension	①	①	
Fuel pipes		①	every 4 years: ③
Front and rear brake pad wear	①	①	

① = check, clean, adjust, lubricate or change, if necessary. ② = clean; ③ = change; ④ = adjust.

Carry out the maintenance operations more frequently if you use the vehicle in rainy and dusty areas or on uneven ground. Have maintenance operations on the components indicated by  carried out by **aprilia** Official Dealers ONLY.



IDENTIFICATION DATA

It is a good rule to write down the frame and engine numbers in the space provided in this manual.

The frame number can be used for the purchase of spare parts.

 **Do not alter the identification numbers if you do not want to incur severe penal and administrative sanctions. In particular, the alteration of the frame number results in the immediate invalidity of the guarantee.**



ENGINE NUMBER

The engine number is stamped on the rear part of the left engine crankcase.

Engine no. _____



FRAME NUMBER

The frame number is stamped on the right side of the steering column.

Frame no. _____

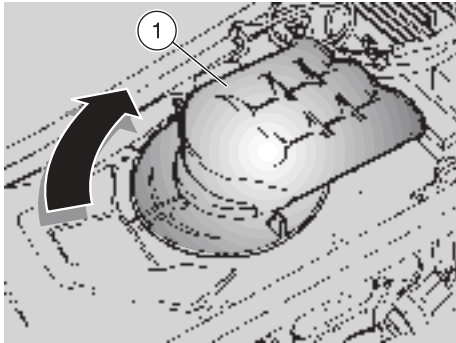

AIR CLEANER



Remember:

1 miles = 1.6 km
1 km = 0.625 miles

Check the air cleaner every 6000 km or 8 months, change it every 12000 km or more frequently if the vehicle is used on dusty or wet roads.

It is possible to clean the air cleaner partially after using the vehicle on this kind of roads.



The partial cleaning of the filter does not exclude or postpone the replacement of the filter itself.

REMOVAL

- ◆ Remove the saddle, see p. 19 (UNLOCKING/LOCKING THE SADDLE).
- ◆ Rotate the air cleaner conveyor (1) clockwise, raise and remove it.
- ◆ Extract the air cleaner (2).

Partial cleaning



Do not press or strike the metal net of the air cleaner.
Do not use screwdrivers or alike.

- ◆ Seize the air cleaner vertically and strike it more than once on a clean surface.
- ◆ If necessary, clean the filter with a compressed air jet (directing it from the inside towards the outside of the filter).
- ◆ Clean the outer part of the air cleaner with a cloth.

Changing

- ◆ Replace the air cleaner with a new one of the same type.
- ◆ Make sure that the gasket (3) is intact; if it is damaged, change it.
- ◆ Every 6000 km, remove the plug (4), so that any impurity that may have accumulated inside the filter case can be discharged.



CHECKING THE ENGINE OIL LEVEL AND TOPPING UP

Carefully read p. 21 (ENGINE OIL) and p. 36 (MAINTENANCE).



Remember:

1 miles = 1.6 km
1 km = 0.625 miles

Check the engine oil level every 500 km, change it after the first 1000 km and successively every 6000 km, see p. 40 (CHANGING THE ENGINE OIL AND THE OIL FILTER).

To carry out the checking:



Position the vehicle on firm and flat ground.

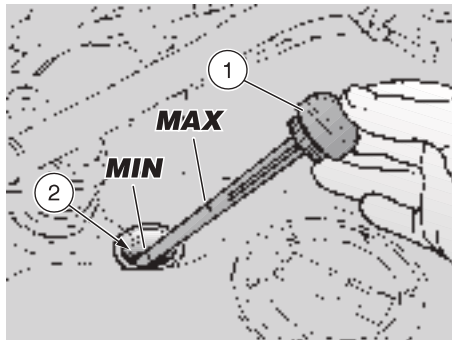

- ◆ Stop the engine and let it cool down for at least ten minutes, in order to allow the oil to flow back to the oil pan and to cool down.
- ◆ Start the engine, see p. 30 (STARTING) and let it idle for about one minute, in order to ensure the filling up of the oil tank.
- ◆ Stop the engine.
- ◆ Keep the vehicle in vertical position, with the two wheels resting on the ground.



The non-performance of the operations described above may result in a wrong measurement of the level.

- ◆ Unscrew and extract the plug/dipstick (1).
- ◆ Clean the part in contact with the oil with a clean cloth.
- ◆ Insert the plug/dipstick in the filling hole (2) completely, without tightening it.

- ◆ Withdraw the plug/dipstick (1) again and read the oil level on the graduated marking:

MAX = maximum level

MIN = minimum level

The difference between "MAX" and "MIN" is about 300 cm³.

- ◆ The level is correct if the oil reaches approx the "MAX" mark on the dipstick.



Never exceed the "MAX" mark, nor leave the oil below the "MIN" mark, in order to avoid serious damage to the engine.

- ◆ If necessary, top up the engine oil tank through the filling hole (2), after extracting the plug/dipstick (1).

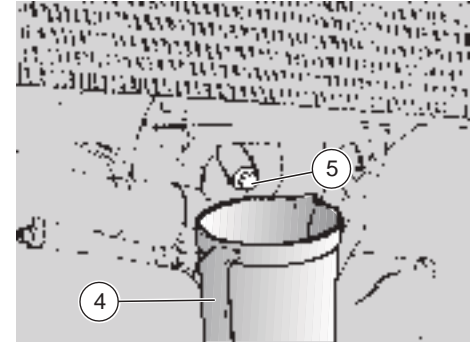
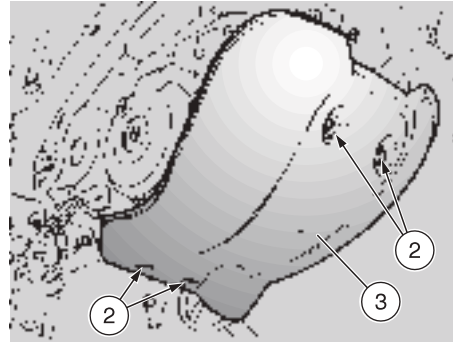
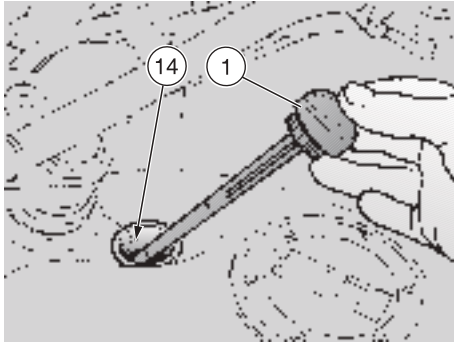

CHANGING THE ENGINE OIL AND THE OIL FILTER

Carefully read p. 21 (ENGINE OIL) and p. 36 (MAINTENANCE).



Remember:

1 miles = 1.6 km

1 km = 0.625 miles

Check the engine oil level every 500 km, change it after the first 1000 km and successively every 6000 km.

To change the oil, proceed as follows:



Position the vehicle on firm and flat ground.

- ◆ Stop the engine and let it cool down for at least ten minutes, in order to allow the oil to flow back to the oil pan and to cool down.

- ◆ Start the engine, see p. 30 (STARTING) and let it idle for a few minutes, in order to facilitate the outflow of the oil during the draining phase.
- ◆ Stop the engine.
- ◆ Keep the vehicle in vertical position, with the two wheels resting on the ground.



When warmed up, the engine contains hot oil; therefore, while carrying out the operations described here below be particularly careful, in order to avoid burns.

- ◆ Unscrew and extract the plug/dipstick (1).
- ◆ Unscrew and remove the four screws (2).
- ◆ Remove the oil pan guard (3).
- ◆ Put a container (4) with at least 2500 cm³ capacity in correspondence with the drain plug on the frame (5).

- ◆ Unscrew and remove the drain plug positioned on the frame (5).
- ◆ Drain the oil and let it drip into the container (4) for a few minutes.
- ◆ Check and if necessary change the sealing washer of the drain plug positioned on the frame (5).
- ◆ Screw and tighten the drain plug positioned on the frame (5).

Driving torque of the drain plug positioned on the frame: 27 Nm (2.7 kgm).

- ◆ Move the container (4) and position it under the engine base, in correspondence with the drain plug positioned on the engine (6).
- ◆ Unscrew and remove the drain plug positioned on the engine (6).
- ◆ Drain the oil and let it drip inside the container (4) for a few minutes.

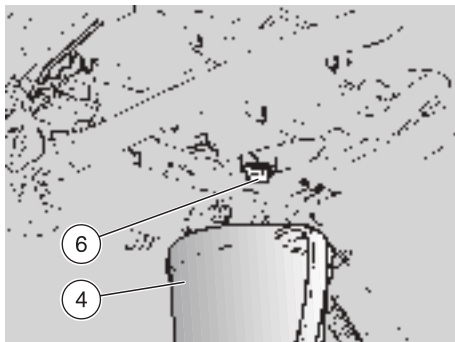

- ◆ Remove the metal residues from the drain plug (6) magnet.
- ◆ Check and if necessary replace the sealing washer of the drain plug (6).

Change the sealing washer of the drain plug (6) every 12000 km (or every second engine oil change).

- ◆ Screw and tighten the drain plug (6).

Driving torque of the drain plug (6) positioned on the engine: 40 Nm (4 kgm).

Clean the engine oil filter positioned on the frame (7) every 12000 km (or every second engine oil change).

 **Prepare a pipe clamp (8) to replace the original one (special type).**

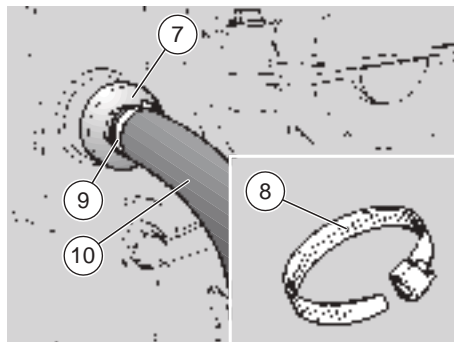

- ◆ Loosen the clamp (9) and disconnect the pipe (10).
- ◆ Unscrew and remove the engine oil filter positioned on the frame (7) and clean it with a compressed air jet.
- ◆ Check the seal of the engine oil filter positioned on the frame (7), screw and tighten it.

Driving torque of the engine oil filter positioned on the frame: 35 Nm (3.5 kgm).

- ◆ Connect the pipe (10) and tighten the new clamp (8).

Change the engine oil filter after the first 1000 km and successively every 6000 km (or every time you change the oil).

- ◆ Unscrew the two screws (11) and remove the cover (12).

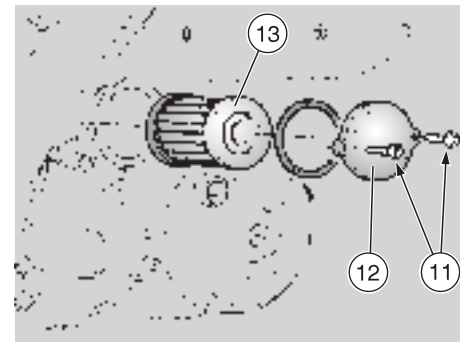

- ◆ Remove the engine oil filter (13).
- ◆ Spread an oil film on the sealing ring of the new engine oil filter.
- ◆ Fit the new engine oil filter.
- ◆ Put back the cover (12), screw and tighten the two screws (11).
- ◆ Pour about 1600 cm³ of engine oil through the filling opening (14), see p. 68 (LUBRICANT TABLE).
- ◆ Tighten the plug/dipstick (1).
- ◆ Start the engine, see p. 30 (STARTING) and let it idle for about one minute, in order to ensure the filling up of the engine oil circuit.
- ◆ Unscrew and extract the plug/dipstick (1).
- ◆ Pour other 600 cm³ of oil through the filling opening (14).
- ◆ Check the oil level, see p. 39 (CHECKING THE ENGINE OIL LEVEL AND TOPPING UP).

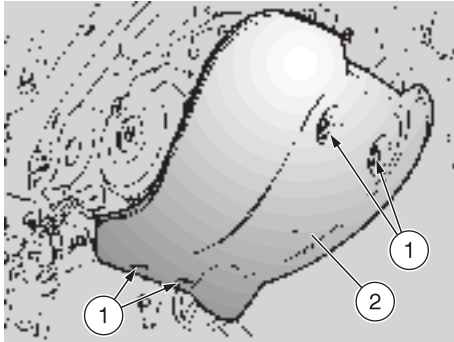

FRONT WHEEL

 The disassembly and reassembly of the front wheel may be difficult for unskilled operators. If necessary, contact an **aprilia** Official Dealer.

If you want to perform these operations personally, keep to the following instructions.

Carefully read p. 36 (MAINTENANCE).

While disassembling and reassembling the wheel, be careful not to damage the brake pipe, the disc and the pads.

Before performing the operations described here below, let the engine and the silencer cool down until they reach room temperature, in order to avoid burns.

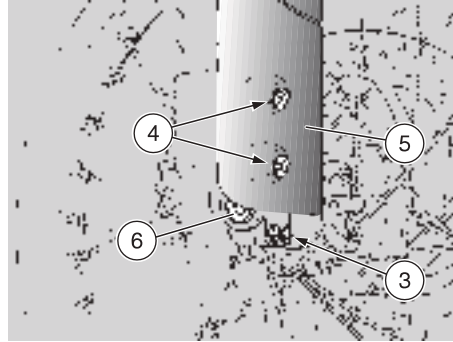

DISASSEMBLY

- ◆ Position the vehicle on the stand, see p. 35 (POSITIONING THE VEHICLE ON THE STAND).
- ◆ Unscrew and remove the four screws (1).
- ◆ Remove the oil pan guard (2).

 Due to the weight and dimensions of the vehicle, the following operation cannot be performed by one person only.

Proceed with care and make sure that you can support the weight of the vehicle.

 **Weight of the vehicle without driver (ready for starting): 200 kg**

- ◆ Raise the front part of the vehicle and have a suitable support (the weight of which should be about 350 mm) placed under the engine, so that the front wheel can rotate freely and the vehicle cannot fall down.



 The vehicle may fall down. Provide for balancing the vehicle, in order to prevent it from falling down.

- ◆ Position and fix a load weighing about 40 kg on the rear luggage rack, in order to support the front part of the vehicle.

 Make sure that the vehicle is stable.

- ◆ Have the handlebar held still in driving position, so that the steering is locked.
- ◆ Loosen the two screws (3) of the wheel pin clamp.
- ◆ Unscrew and remove the two screws (4).
- ◆ Move the mudguard support (5) as much as necessary and unscrew the wheel pin (6).

 To facilitate the extraction of the wheel pin, slightly lift the wheel.

- ◆ Manually extract the wheel pin (6).
- ◆ Take the spacer ring (left side).

 **Upon removal, check the position of the speedometer/odometer control: it will be useful during the reassembly.**

- ◆ Remove the speedometer/odometer control (7) from the wheel seat.
- ◆ Remove the wheel, carefully withdrawing the disc from the brake caliper.

 **Never pull the front brake lever after removing the wheel, otherwise the caliper pistons may go out of their seats, thus causing the outflow of the brake fluid. In this case consult your **aprilia** Official Dealer, who will carry out the proper maintenance operation.**

REASSEMBLY

Carefully read p. 36 (MAINTENANCE).

 **While reassembling the wheel, be careful not to damage the brake pipe, the disc and the pads.**

 **Insert the disc in the brake caliper with care.**

- ◆ Position the wheel between the fork rods.

 **Grease the inside of the speedometer/odometer control, see p. 68 (LUBRICANT TABLE).**

- ◆ Position the speedometer/odometer control tang (7) in the relevant seat in the wheel hub.
- ◆ Correctly position the odometer control seat in correspondence with the special antirotation pin (8).
- ◆ Shift the mudguard support (5) as much as necessary to insert the wheel pin (6) partially (from the right side of the vehicle).
- ◆ Insert the spacer ring between the wheel hub and the fork left rod.

 **Grease the wheel pin, see p. 68 (LUBRICANT TABLE).**

- ◆ Insert the wheel pin (6) completely (fitting the spacer ring) and tighten it.

**Wheel pin nut driving torque:
80 Nm (8 kgm).**

- ◆ Correctly position the mudguard support (5).

 **Due to the weight and dimensions of the vehicle, the following operation cannot be performed by one person only. Proceed with care and make sure that you can support the weight of the vehicle.**

 **Weight of the vehicle without driver (ready for starting):
200 kg.**

- ◆ Raise the front part of the vehicle and remove the support positioned under the engine during disassembly.
- ◆ Lower the vehicle and position it on the stand.
- ◆ Correctly position the oil pan guard (2).
- ◆ Screw and tighten the four screws (1).
- ◆ With pulled front brake lever, press the handlebar repeatedly, thrusting the fork downwards. In this way the fork rods will settle properly.
- ◆ Screw and tighten the two screws (4).
- ◆ Tighten the wheel pin clamp screws (3).

**Wheel pin clamp screw driving torque:
10 Nm (1 kgm).**

 **After reassembly, pull the front brake lever repeatedly and check the correct functioning of the braking system.**

Check the wheel centering.

Have the driving torques, centering and balancing of the wheel checked by your **aprilia Official Dealer, in order to avoid accidents that may be harmful for you and/or other people.**

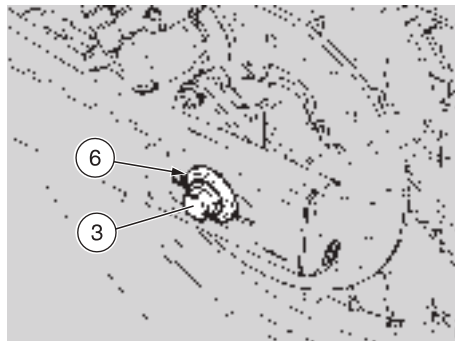
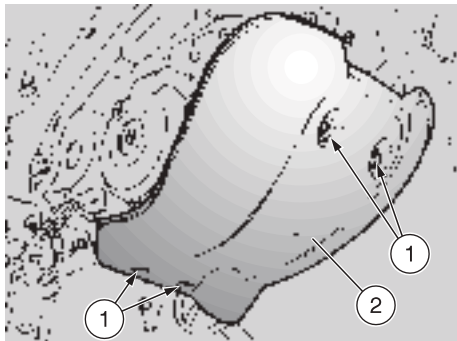

REAR WHEEL



The disassembly and reassembly of the rear wheel may be difficult for unskilled operators. If necessary, contact an **aprilia** Official Dealer.

If you want to perform these operations personally, keep to the following instructions.

Carefully read p. 36 (MAINTENANCE).

Before carrying out the following operations, let the engine and the silencer cool down until they reach room temperature, in order to avoid burns.



While disassembling and reassembling the wheel, be careful not to damage the brake pipe, the disc and the pads.

DISASSEMBLY

- ◆ Position the vehicle on the stand, see p. 35 (POSITIONING THE VEHICLE ON THE STAND).
- ◆ Unscrew and remove the four screws (1).
- ◆ Remove the oil pan guard (2).



Due to the weight and dimensions of the vehicle, the following operation cannot be performed by one person only. Proceed with care and make sure that you can support the weight of the vehicle.



Weight of the vehicle without driver (ready for starting): 200 kg.

- ◆ Raise the rear part of the vehicle, have a suitable support (the height of which should be 350 mm) placed under the engine, so that the rear wheel can rotate freely and the vehicle cannot fall down.



The vehicle may fall down. Provide for balancing the vehicle, in order to prevent it from falling down.

Make sure that the vehicle is stable.

- ◆ Lock the wheel pin (3) rotation, by means of the suitable spanner.
- ◆ Unscrew and remove the nut (4) and take the washer (5).

Wheel nut driving torque:
100 Nm (10 kgm).



To facilitate the extraction of the wheel pin, slightly raise the wheel.

- ◆ Extract the wheel pin (3) manually and take the washer (6).
- ◆ Make the rear wheel advance and release the drive chain (7) from the crown gear (8).
- ◆ Withdraw the wheel from the rear fork from behind, carefully withdrawing the disc from the brake caliper.

 **Never pull the rear brake lever after removing the wheel, otherwise the caliper piston may go out of its seat, thus causing the outflow of the brake fluid. In this case consult your **aprilia** Official Dealer, who will carry out the proper maintenance operation.**

REASSEMBLY

 **Carefully insert the disc in the brake caliper.**

- ◆ Position the rear wheel between the rods of the rear fork.
- ◆ Make the wheel advance and position the drive chain (7) on the crown gear (8).

 **Risk of injuries. Do not use your fingers to align the seats.**

- ◆ Make the wheel move backwards and align the pin seat on the wheel hub with the pin seats on the rods of the rear fork.

 **Grease the wheel pin, see p. 68 (LUBRICANT TABLE).**

 **To facilitate the insertion of the wheel pin, slightly raise the wheel.**

- ◆ Insert the wheel pin (3) complete with washer (6) from the left side of the vehicle.

 **Make sure that the wheel pin has been inserted completely.**

- ◆ Fit the washer (5) and screw the nut (4) completely.
- ◆ Check the chain tension, see p. 46 (CHAIN).
- ◆ Lock the wheel pin (3) rotation by means of the suitable spanner and tighten the nut (4).

**Wheel pin-nut driving torque:
100 Nm (10 kgm).**

 **Due to the weight and dimensions of the vehicle, the following operation cannot be performed by one person only. Proceed with care and make sure that you can support the weight of the vehicle.**

 **Weight of the vehicle without driver (ready for starting): 200 kg.**

- ◆ Raise the rear part of the vehicle and remove the support positioned under the engine during disassembly.
- ◆ Lower the vehicle and position it on the stand.
- ◆ Correctly position the oil pan guard (2).
- ◆ Screw and tighten the four screws (1).

 **After reassembly, pull the rear brake lever repeatedly and check the correct functioning of the braking system.**

Check the wheel centering.

Have the driving torques, centering and balancing of the wheel checked by your **aprilia Official Dealer, in order to avoid accidents that may be harmful for you and/or other people.**

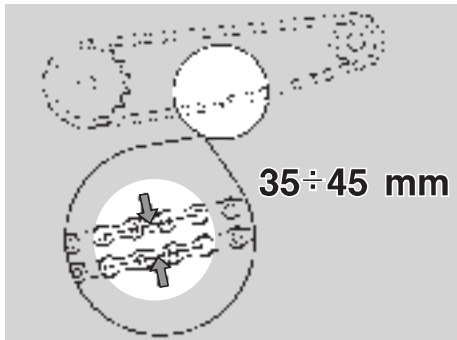

CHAIN

Carefully read p. 36 (MAINTENANCE).

The vehicle is equipped with an endless chain, in which the ring link joint is not used.



An excessive slackening of the chain can cause it to come off of the sprockets, which often results in accidents or serious damage to the vehicle.

Periodically check the slack and adjust it if necessary, see beside (ADJUSTMENT).

To change the chain, contact an **aprilia** Official Dealer, who will ensure you prompt and accurate servicing.



Incorrect maintenance may cause the untimely wear of the chain and/or damages to the pinion and/or the crown.

Carry out the maintenance operations more frequently if you use the vehicle in difficult conditions or on dusty and/or muddy roads.

CHECKING THE SLACK

To check the slack, proceed as follows:

- ◆ Stop the engine.
- ◆ Position the vehicle on the stand, see p. 35 (POSITIONING THE VEHICLE ON THE STAND).
- ◆ Position the shifting lever in neutral.
- ◆ Make sure that the vertical oscillation, in an intermediate point between pinion and crown in the lower part of the chain, is about 35 ÷ 45 mm.
- ◆ Move the vehicle forwards, or turn the wheel, in order to be able to check the vertical oscillation of the chain even when the wheel turns; the slack must be constant in all the rotation phases of the wheel.



If in some positions the slack is higher than in others, this means that there are crushed or seized links; in this case, contact an **aprilia Official Dealer. To prevent the risk of seizures, lubricate the chain frequently, see p. 47 (LUBRICATION AND CLEANING).**

If the slack is uniform, but higher or lower than 35 ÷ 45 mm, adjust it, see beside (ADJUSTMENT).

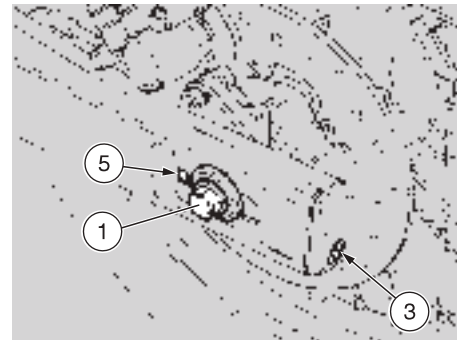

ADJUSTMENT

If after the check it is necessary to adjust the chain tension, proceed as follows:

- ◆ Lock the rotation of the wheel pin (1) by means of the suitable spanner.
- ◆ Loosen the nut (2).



For the wheel centering numbered reference marks are provided, which are connected with the movement of the adjusters (3) and (4). These reference marks can be seen inside two slots (5) and (6) positioned on the rods of the rear fork, before the wheel pin.

- ◆ Act on the left (3) and right (4) adjusters and adjust the chain slack, making sure that the slots (5) and (6) coincide with the same reference marks on both sides of the vehicle.



- ◆ Lock the wheel pin (1) rotation by means of the suitable spanner.
- ◆ Tighten the nut (2).

**Wheel pin-nut driving torque:
100 Nm (10 kgm).**

- ◆ Check the chain slack, see p. 46 (CHECKING THE SLACK).

**CHECKING THE WEAR OF CHAIN,
PINION AND CROWN**

Further, check the chain and sprockets and make sure that they do not present:

- ◆ Damaged rollers.
- ◆ Loose pins.
- ◆ Dry, rusty, crushed or seized links.
- ◆ Excessive wear.
- ◆ Lacking O rings.
- ◆ Sprocket or teeth excessively worn or damaged.



If the chain rollers are damaged, the pins are loose and/or the O rings are damaged or lacking, it is necessary to change the whole chain unit (both sprockets and chain).



Lubricate the chain frequently, especially if there are dry or rusty parts. The crushed or seized links must be lubricated and made work again.

If this is not possible, contact an **aprilia Official Dealer, who will provide for changing the chain.**

- ◆ Finally, check the wear of the rear fork protection shoe.

LUBRICATION AND CLEANING



The drive chain is provided with O rings among the links, in order to keep the grease inside them. Carry out the adjustment, lubrication, cleaning and change of the chain with great care.



Remember:

1 miles = 1.6 km

1 km = 0.625 miles

Lubricate the chain every 500 km or whenever necessary.

Lubricate the chain with spray grease for chains only, see p. 68 (LUBRICANT TABLE).

Never wash the chain with water jets, steam jets, high-pressure water jets and highly inflammable solvents.

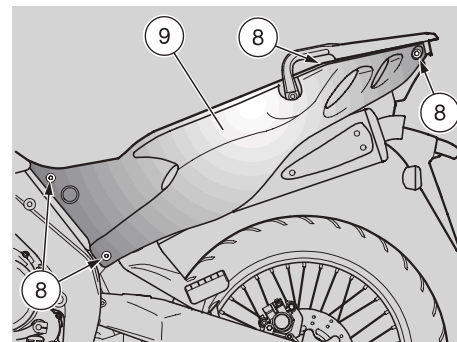
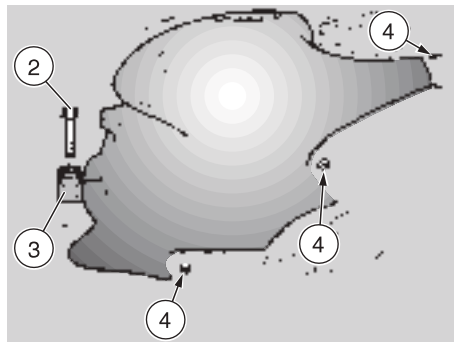
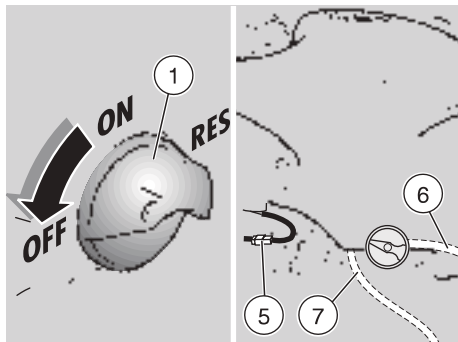

REMOVING THE FUEL TANK

Carefully read p. 21 (FUEL) and p. 36 (MAINTENANCE).

- ◆ Position the vehicle on the stand, see p. 35 (POSITIONING THE VEHICLE ON THE STAND).

! Risk of fire.
Wait until the engine and the exhaust silencer have completely cooled down.

! Fuel vapours are noxious for your health.
Before proceeding, make sure that the room in which you are working is properly ventilated.
Do not inhale fuel vapours.
Do not smoke and do not use naked flames. Do not dispose of fuel in the environment.

- ◆ Remove the saddle, see p. 19 (UNLOCKING/LOCKING THE SADDLE).
- ◆ Move the fuel tap lever (1) to position "OFF".
- ◆ Unscrew and remove the central screw (2).
- ◆ Take the rubber element (3).
- ◆ ★ Unscrew and remove the three screws (4).
- ◆ Disconnect the electric connector (5) of the low fuel sensor.
- ◆ Disconnect the water drain pipe (7) from the fuel tank plug.
- ◆ Disconnect the fuel breather pipe (7).
- ◆ Lift the tank and remove it.

REMOVING THE RIGHT AND LEFT SIDES

Carefully read p. 36 (MAINTENANCE).

- ◆ Remove the saddle, see p. 19 (UNLOCKING/LOCKING THE SADDLE).
- ◆ Unscrew and remove the four screws (8).
- ◆ Remove the side (9).

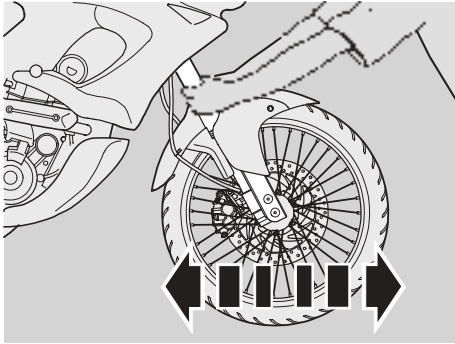

CHECKING THE STEERING

Carefully read p. 36 (MAINTENANCE).

Every now and then it is advisable to check the steering, in order to verify if there are slacks.

To check the steering it is necessary to:

- ◆ Carry out the first four operations relevant to the disassembly of the front wheel, see p. 42 (DISASSEMBLY).
- ◆ Keep the rear part of the vehicle down.
- ◆ Shake the fork in the direction of travel (see figure).



If you find that there is a considerable slack, contact your **aprilia** Official Dealer to restore the optimal steering conditions.

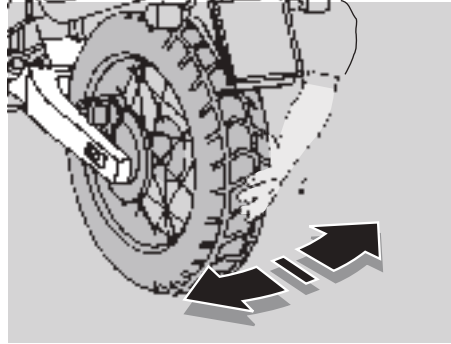

CHECKING THE REAR FORK FULCRUM AXIS

Carefully read p. 36 (MAINTENANCE).

Periodically check the tightening of the pin and of the needle bearings of the rear fork.

To carry out this operation, proceed as follows:

- ◆ Carry out the first four operations relevant to the disassembly of the rear wheel, see p. 44 (DISASSEMBLY).
- ◆ Shake the wheel perpendicularly to the direction of travel (see figure).



If you find that there is a considerable slack, contact your **aprilia** Official Dealer to restore the optimal use conditions.

INSPECTING THE FRONT AND REAR SUSPENSIONS



Have the front suspension oil changed by an **aprilia** Official Dealer, who will ensure you prompt and accurate servicing.

Carefully read p. 36 (MAINTENANCE).



Remember:
1 miles = 1.6 km
1 km = 0.625 miles

Change the front suspension oil every 12000 km.

Further, carry out the following checking operations:

- ◆ With pulled front brake lever, press the handlebar repeatedly, thrusting the fork downwards.
The stroke must be gentle and there must be no trace of oil on the rods.
- ◆ Check the fastening of all the components and the functionality of the front and rear suspension joints.



If you notice irregularities in the operation or if the help of a qualified technician is necessary, contact your **aprilia** Official Dealer.

REAR SUSPENSION

The rear suspension consists of a spring-shock absorber unit, fixed to the frame by means of silent-blocks.

For the setting of the vehicle attitude, the shock absorber is provided with an adjusting ring nut (1), a locking ring nut (2) and a screw (3) for the adjustment of the hydraulic braking with extended shock absorber.

The standard adjustment, set by the manufacturer, is suitable for a driver weighing about 70 kg.

If your weight and needs are different, for example in case of ride with passenger and full load, contact an **aprilia** Official Dealer.

 **Adjust the hydraulic braking with extended shock absorber according to the conditions of use of the vehicle.**

 **If the vehicle attitude has been set for full load, do not turn the screw (3) to the left (anticlockwise), in order to avoid sudden jerks while riding.**
If necessary, contact an **aprilia Official Dealer.**

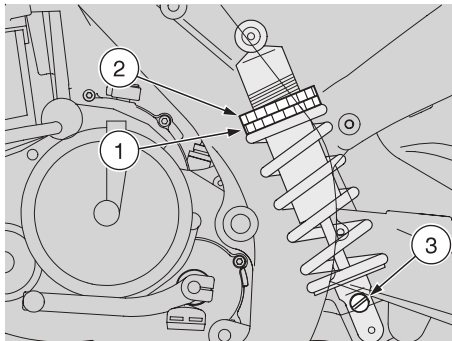

According to the conditions of use of the vehicle, it is possible to adjust the hydraulic braking with extended shock absorber by adjusting the screw (3); for the adjustment, keep to the following indications:

Raveled or irregular road surface - hard adjustment:

- ◆ rotate the screw (3) to the right (clockwise).

Normal or regular road surface - soft adjustment:

- ◆ rotate the screw (3) to the left (anticlockwise).

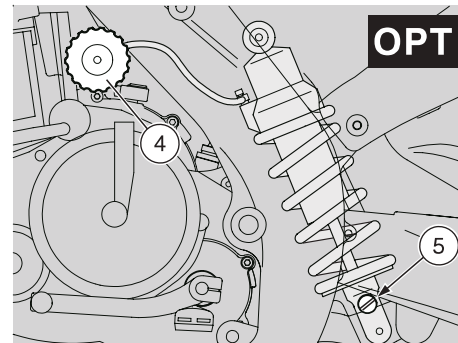

REAR SUSPENSION WITH HYDRAULIC PRELOAD ADJUSTMENT **OPT**

Thanks to this kind of suspension, it is possible to adjust the preload of the spring and of the hydraulic braking with extended shock absorber.

 **Adjust the preload of the spring and of the hydraulic braking with extended shock absorber according to the conditions of use of the vehicle.**

When the spring preload is increased, it is necessary to increase also the hydraulic braking with extended shock absorber, in order to avoid sudden jerks while riding.

ADJUSTING THE PRELOAD OF THE SPRING AND OF THE HYDRAULIC BRAKING WITH EXTENDED SHOCK ABSORBER **OPT**

Soft adjustment - for light load (for example, solo rider).

Spring:

- ◆ Rotate the handwheel (4) completely leftwards (anticlockwise).

Shock absorber:

- ◆ Rotate the adjusting screw (5) completely leftwards (anticlockwise).

Intermediate adjustment - for normal load (for example, rider and passenger).

Spring:

- ◆ Starting from the soft adjustment position, rotate the handwheel (4) rightwards (clockwise), giving it 25 clicks.

Shock absorber:

- ◆ Starting from the soft adjustment position, rotate the adjusting screw (5) rightwards (clockwise), giving it a full turn (9 clicks).

Hard adjustment - for heavy load (for example, rider, passenger and luggage).

Spring:

- ◆ Rotate the handwheel (4) completely rightwards (clockwise).

Shock absorber:

- ◆ Rotate the adjusting screw (5) completely rightwards (clockwise).

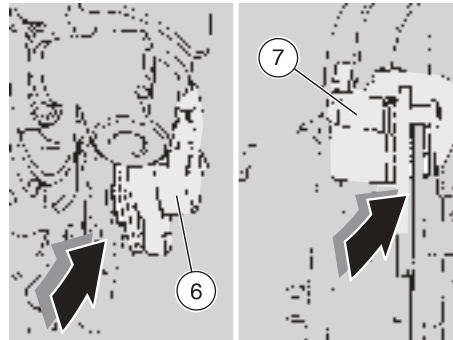

CHECKING THE BRAKE PAD WEAR

Carefully read p. 22 (BRAKE FLUID (recommendations)), p. 22 (DISC BRAKES), p. 36 (MAINTENANCE).

The following information refer to a single braking system, but are valid for both.



Remember:

1 miles = 1.6 km

1 km = 0.625 miles

Check the brake pad wear after the first 1000 km and successively every 6000 km. The wear of the brake pads depends on the use, on the kind of drive and on the road. The wear will be greater when the vehicle is driven on dirty or wet roads.

To carry out a rapid checking of the wear of the pads, proceed as follows:

- ◆ Position the vehicle on the stand, see p. 35 (POSITIONING THE VEHICLE ON THE STAND).
- ◆ Carry out a visual checking of the friction material thickness by looking between the brake caliper and the pads. Proceed:
 - from below for the front brake caliper (6).
 - from above for the rear brake caliper (7).
- ◆ If the thickness of the friction material (even of one pad only) has reduced to about 1 mm, replace both pads.



Have the pads changed by your **aprilia Official Dealer**.

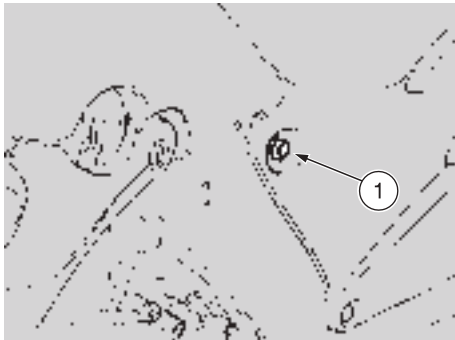

IDLING ADJUSTMENT

Carefully read p. 36 (MAINTENANCE).

Adjust the idling every time it is irregular.

To carry out this operation, proceed as follows:

- ◆ Ride for a few miles until reaching the normal running temperature, see p. 15 (Coolant temperature indicator “ 上 ”).
- ◆ Keep the vehicle in vertical position, with both wheels resting on the ground.
- ◆ Check the engine idling rpm on the revolution counter.

The engine idling speed must be about 1400 ± 100 rpm.

If necessary:

- ◆ Adjust the knob (1) positioned on the left side of the vehicle.

By **SCREWING IT** (clockwise), you increase the engine rpm.

By **UNSCREWING IT** (anticlockwise), you decrease the engine rpm.

- ◆ Twist the throttle grip, accelerating and decelerating a few times to make sure that it functions correctly and to check if the idling speed is constant.

 **Do not adjust the air screw, to avoid variations of the carburation setting.**

If necessary, contact your **aprilia** Official Dealer.

ADJUSTING THE ACCELERATOR CONTROL

Carefully read p. 36 (MAINTENANCE).

The ideal slack of the accelerator control should be about 2-3 mm.

To adjust the slack, proceed as follows:

- ◆ Remove the protection element (2).
- ◆ Loosen the nut (3) (by screwing it).
- ◆ Act on the adjuster (4) placed at the beginning of the accelerator control cable.

Once you have carried out the adjustment, tighten the nut (3) (by unscrewing it), thus locking the adjuster (4) and put back the protection element (2).

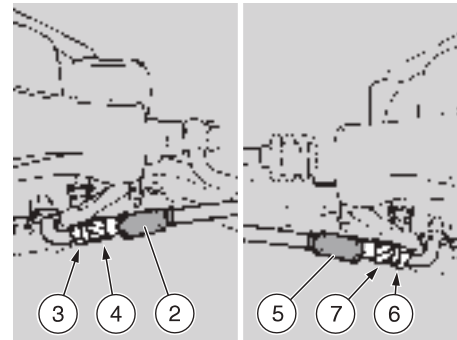

ADJUSTING THE COLD START CONTROL (|>|)

Carefully read p. 36 (MAINTENANCE).

The ideal slack of the cold start control should be about 2-3 mm.

To adjust the slack, proceed as follows:

- ◆ Remove the protection element (5).
- ◆ Loosen the nut (6) (by screwing it).
- ◆ Act on the adjuster (7) placed at the beginning of the accelerator control cable.

Once you have carried out the adjustment, tighten the nut (6) (by unscrewing it), thus locking the adjuster (7) and put back the protection element (5).



SPARK PLUG

Carefully read p. 36 (MAINTENANCE).



Remember:

1 miles = 1.6 km

1 km = 0.625 miles

Check the spark plug every 6000 km, change it every 12000 km. Periodically remove the spark plug and clean it carefully, removing carbon deposits; change it if necessary.

To reach the spark plug:

- ◆ Remove the fuel tank, see p. 48 (REMOVING THE FUEL TANK).

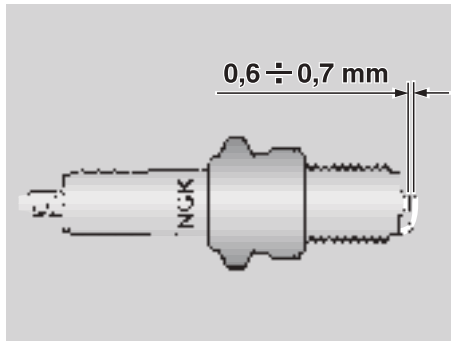

To remove and clean the spark plug:

- ◆ Take off the spark plug cap (1).
- ◆ Remove all the dirt from the base of the spark plug, then unscrew it with the spanner you will find in the tool kit and extract it from its seat, taking care that neither dust nor other substances enter the cylinder.
- ◆ Make sure that there are neither carbon deposits, nor corrosion marks on the electrode and on the central porcelain part; if necessary, clean them with the special cleaners for spark plugs, with an iron wire and/or a metal brush.

- ◆ Energetically blow some air, in order to prevent the removed residues from getting into the engine.

If the spark plug has crackings on the insulating material, corroded electrodes or excessive deposits, it must be changed.

- ◆ Check the spark plug gap with a thickness gauge.

The gap must be $0.6 \div 0.7$ mm; if necessary adjust it, carefully bending the earth electrode.

- ◆ Make sure that the washer is in good conditions.

With the washer on, screw the spark plug by hand in order not to damage the thread.

- ◆ Tighten the spark plug by means of the spanner you will find in the tool kit, giving it half a turn to compress the washer.

Spark plug driving torque:
20 Nm (2 kgm).



The spark plug must be well tightened, otherwise the engine may overheat and be seriously damaged.

Use the recommended type of spark plug only, see p. 65 (TECHNICAL DATA), in order not to compromise the life and performance of the engine.

- ◆ Position the spark plug cap properly, so that it does not come off due to the vibrations of the engine.
- ◆ Put back the fuel tank.

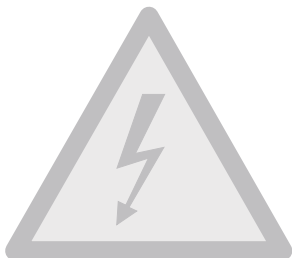

In case of contact with the skin, rinse with plenty of water.

In case of contact with the eyes, rinse with plenty of water for fifteen minutes, then consult an oculist without delay.

If the electrolyte is accidentally swallowed, drink a lot of water or milk, then continue drinking milk of magnesia or vegetable oil and consult a doctor without delay.

The battery gives off explosive gases; keep it away from flames, sparks, cigarettes and any other source of heat.

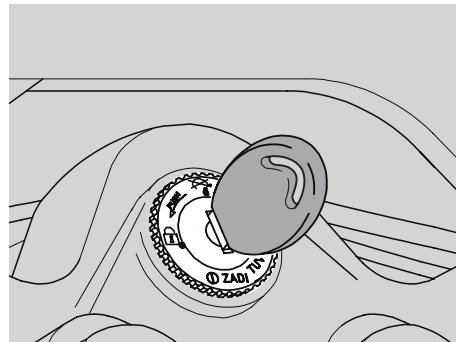

During the recharging or the use, make sure that the room is properly ventilated and avoid inhaling the gases released during the recharging.

KEEP AWAY FROM CHILDREN

Never invert the connection of the battery cables.

Do not incline the vehicle too much, in order to avoid dangerous leaks of the battery fluid.

Connect and disconnect the battery with the ignition switch in position "⊗".

Connect first the positive cable (+) and then the negative cable (-). Disconnect following the reverse order.

BATTERY

Carefully read p. 36 (MAINTENANCE).



Remember:

1 miles = 1.6 km

1 km = 0.625 miles

Check the electrolyte level and the tightening of the terminals after the first 1000 km and successively every 6000 km or 8 months.



The electrolyte in the battery is toxic and caustic and if it gets in contact with the skin it can cause burns, since it contains sulphuric acid.

Wear protection clothes, a face mask and/or goggles during maintenance operations.

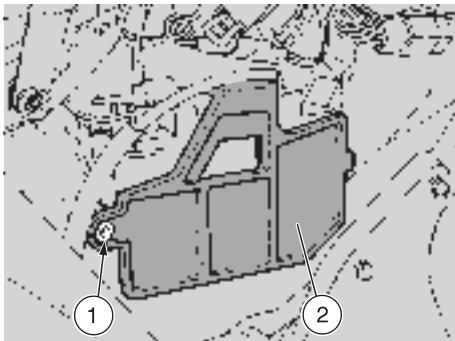

CHECKING THE ELECTROLYTE LEVEL

Carefully read p. 54 (BATTERY).

To check the electrolyte level, proceed as follows:

- ◆ Remove the left side, see p. 48 (REMOVING THE RIGHT AND LEFT SIDES).
- ◆ Unscrew and remove the screw (1).
- ◆ Remove the battery cover (2).
- ◆ Make sure that the fluid level is included between the two "MIN" and "MAX" notches stamped on the battery side. Otherwise:
- ◆ Remove the element plugs.



Never exceed the "MAX" notch, since the level increases during the recharge.

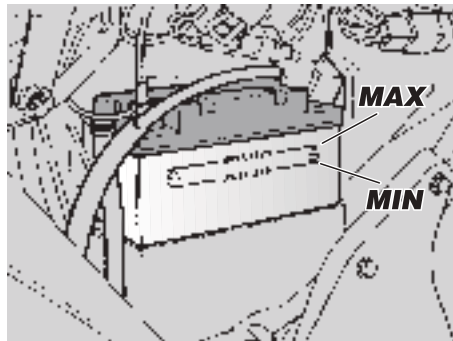

- ◆ Top up by adding distilled water only.

RECHARGING THE BATTERY

Carefully read p. 54 (BATTERY).

Check the electrolyte level, if necessary top up, then:

- ◆ Make sure that the ignition switch is in position "⊗".
- ◆ Disconnect, in order, the negative (-) and positive (+) cable.



Upon reassembly, connect first the positive cable (+) and then the negative cable (-).

- ◆ Remove the battery breather pipe.



Upon reassembly, always connect the battery breather pipe, to prevent the sulphuric acid vapours from corroding the electric system, painted parts, rubber elements or gaskets when they exit the breather pipe itself.

- ◆ Extract the battery from its container and put it in a cool and dry place.
- ◆ Remove the element plugs.
- ◆ Connect the battery with a battery charger.
- ◆ A recharge with an amperage equal to 1/10th of the battery capacity is recommended.
- ◆ After the recharging operation, check the electrolyte level again and if necessary top up with distilled water.

LONG INACTIVITY OF THE BATTERY

If the vehicle remains unused for a long period, remove the battery and place it in a cool and dry place. Recharge it completely, by using a trickle charge.

If the battery remains on the vehicle, disconnect the cables from the terminals.

It is important to check the charge periodically (about once a month), during the winter or when the vehicle remains unused, in order to prevent the deterioration of the battery.

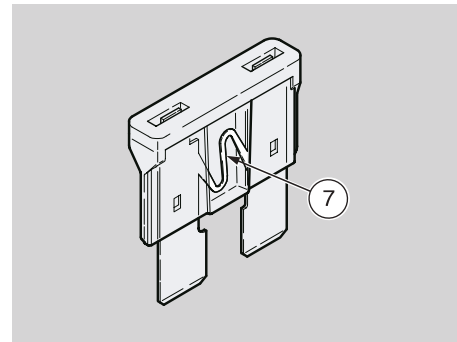
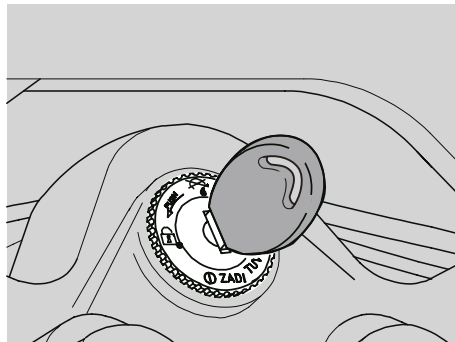
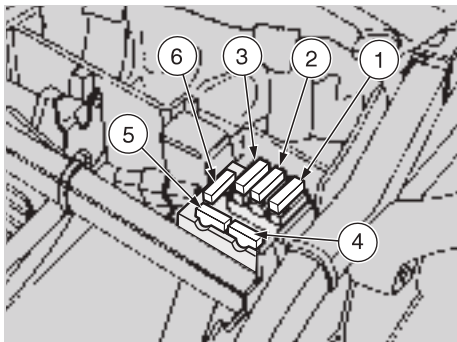

CHANGING THE FUSES

Carefully read p. 36 (MAINTENANCE).



Do not repair faulty fuses.

Never use fuses different from the recommended ones.

The use of unsuitable fuses may cause damages to the electric system or, in case of short circuit, even a fire.



If a fuse blows frequently, there probably is a short circuit or an overload in the electric system. In this case it is advisable to consult an **aprilia Official Dealer.**

If an electric component does not work or works irregularly, or if the vehicle fails to start, it is necessary to check the fuses. Check the 7.5 A and the 15 A fuses first and then the 20A fuse.

7.5 (1), 15 A (2) and 20A (3) fuses:

- ◆ Turn the ignition switch to position "⊗", to avoid any accidental short circuit.
- ◆ Remove the saddle, see p. 19 (UNLOCKING/LOCKING THE SADDLE).
- ◆ Extract the fuses one by one and check if the filament (7) is broken.
- ◆ Before replacing a fuse, try to find out the cause of the trouble, if possible.
- ◆ Replace the damaged fuse with a new one having the same amperage.



If you use one of the spare fuses (4) (5) (6), put a new fuse in the proper seat.

ARRANGEMENT OF THE FUSES

20 A fuse (3) - From the battery to: key switch, regulator, fan.

15 A fuse (2) - From the key switch to: all light loads.

7.5 A fuse (1) - From the key switch to: ignition.

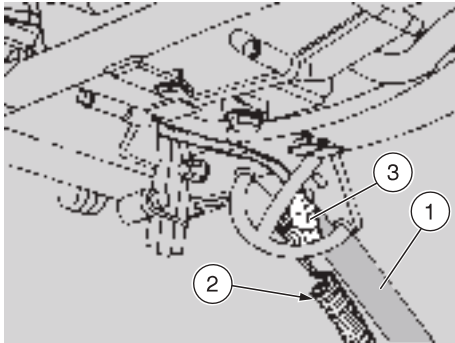

CHECKING THE SIDE STAND AND THE SAFETY SWITCH

Carefully read p. 36 (MAINTENANCE).

The side stand (1) must rotate without hindrances.

Carry out the following checks:

- ◆ The springs (2) must not be damaged, worn, rusty or weakened.
- ◆ The side stand must rotate freely, if necessary grease the joint.

The side stand (1) is provided with a safety switch (3) that makes the starter rotation and the engine ignition impossible with engaged gears and side stand (1) down.

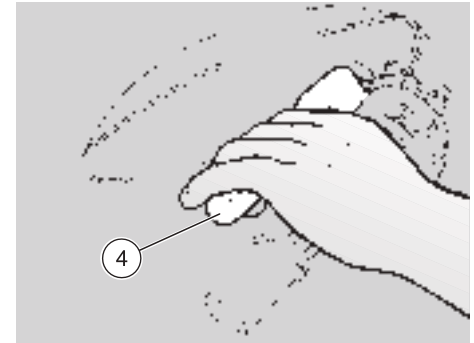
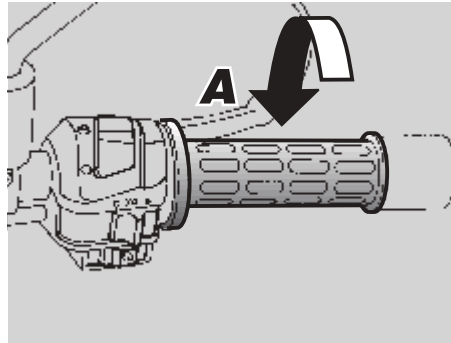

To check the proper functioning of the safety switch (3), proceed as follows:

- ◆ Seat on the vehicle in driving position.
- ◆ Fold the side stand (1).
- ◆ Start the engine, see p. 30 (STARTING).
- ◆ With released throttle grip (**Pos. A**) and engine idling, pull the clutch lever (4) completely.
- ◆ Engage the first gear, pushing the shifting lever (5) downwards.
- ◆ Lower the side stand (1), thus operating the safety switch (3).
At this point the engine must stop.

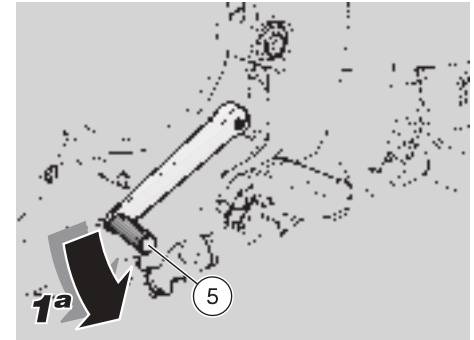

If the engine does not stop, contact an aprilia Official Dealer.

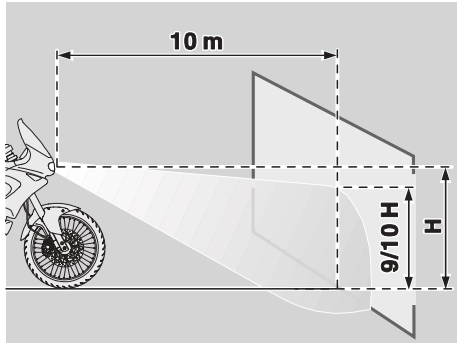

ADJUSTING THE HEADLIGHT BEAM

To rapidly check the correct direction of the beam, place the vehicle on flat ground, 10 m away from a wall.

Turn on the low beam, sit on the vehicle and make sure that the beam projected on the wall is slightly under the horizontal line of the headlight (about 9/10th of the total height).

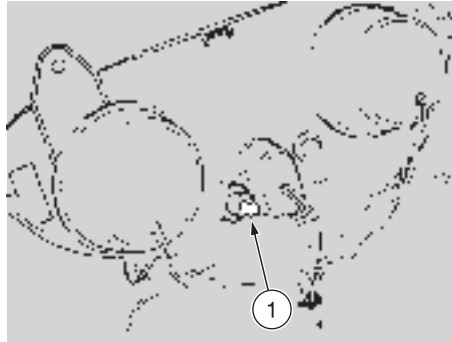

To adjust the headlight beam:

- ◆ Adjust the screw (1) with an 8 mm fixed spanner.
By **SCREWING IT** (clockwise), you set the beam upwards.
By **UNSCREWING IT** (anticlockwise), you set the beam downwards.

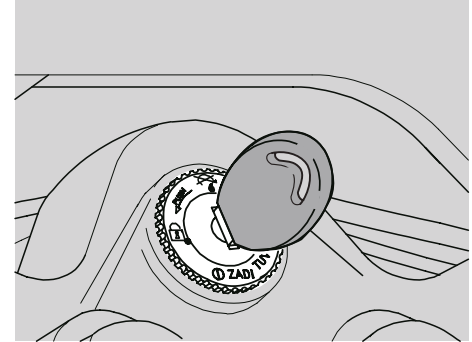

BULBS



Before changing a bulb, turn the ignition switch to position "⊗". Change the bulb wearing clean gloves or using a clean and dry cloth.

Do not leave fingerprints on the bulb, since these may cause its overheating and consequent breakage. If you touch the bulb with bare hands, remove any fingerprint with alcohol, in order to prevent it from blowing frequently.

Carefully read p. 36 (MAINTENANCE).

DO NOT FORCE THE ELECTRIC CABLES

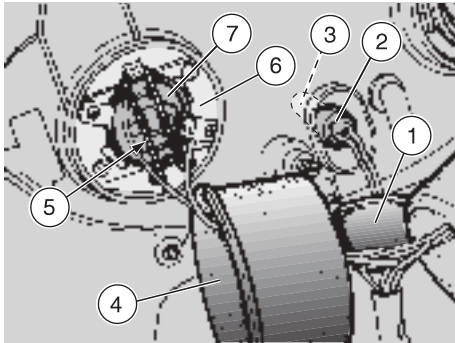

CHANGING THE HEADLIGHT BULBS

Carefully read p. 58 (BULBS).

 Before changing a bulb, check the fuses, see p. 56 (CHANGING THE FUSES).

The headlight contains:

- ◆ One high beam bulb (7) (left side).
- ◆ One parking light bulb (3).
- ◆ One low/high beam bulb (10) (right side).

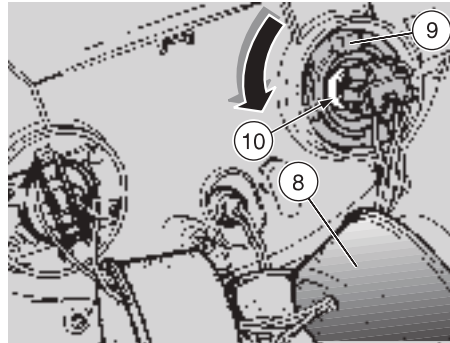

HIGH BEAM BULB (LEFT SIDE)

Carefully read p. 58 (BULBS).

- ◆ Position the vehicle on the stand, see p. 35 (POSITIONING THE VEHICLE ON THE STAND).
- ◆ Move the protection element (4) with your hands.
- ◆ Release the check spring (5) positioned at the rear of the bulb socket (6).
- ◆ Extract the bulb (7) and replace it.

LOW/HIGH BEAM BULB (RIGHT SIDE)

Carefully read p. 58 (BULBS).

- ◆ Position the vehicle on the stand, see p. 35 (POSITIONING THE VEHICLE ON THE STAND).
- ◆ Move the protection element (8) with your hands.
- ◆ Rotate the bulb socket (9) anticlockwise and extract it from its seat.
- ◆ Slightly press the bulb (10) and rotate it anticlockwise.
- ◆ Extract the bulb.

For the installation:

 Insert the bulb in the bulb socket, making the two bulb pins coincide with the relevant guides on the socket.

- ◆ Correctly install a new bulb of the same type.

To change the bulbs, proceed as follows:

PARKING LIGHT BULB

- ◆ Position the vehicle on the stand, see p. 35 (POSITIONING THE VEHICLE ON THE STAND).



To extract the bulb socket, do not pull the electric wires.

- ◆ Move the protection element (1) with your hands.
- ◆ Seize the bulb socket (2), pull it and remove it from its seat.
- ◆ Withdraw the parking light bulb (3) and replace it with one of the same type.

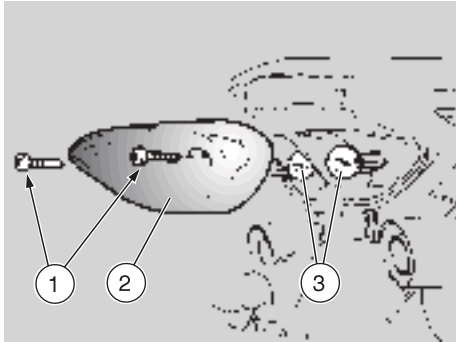

CHANGING THE REAR LIGHT BULB

Carefully read p. 58 (BULBS).

 Before changing a bulb, check the fuses, see p. 56 (CHANGING THE FUSES).

To change the bulb, proceed as follows:

- ◆ Position the vehicle on the stand, see p. 35 (POSITIONING THE VEHICLE ON THE STAND).
- ◆ Unscrew and remove the two screws (1).
- ◆ Pull the protection glass outwards (2), by exerting pressure on the lower area.
- ◆ Press the bulb (3) slightly and rotate it anticlockwise.
- ◆ Extract the bulb from its seat.

For the installation:

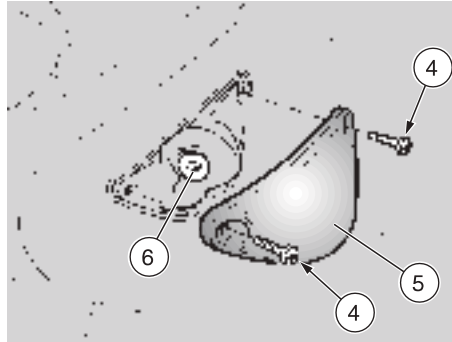

 Insert the bulb in the bulb socket, making the two bulb pins coincide with the relevant guides on the socket.

- ◆ Correctly install a new bulb of the same type.

CHANGING THE FRONT DIRECTION INDICATOR BULBS

Carefully read p. 58 (BULBS).

 Before changing a bulb, check the fuses, see p. 56 (CHANGING THE FUSES).

To change the bulbs, proceed as follows:

- ◆ Position the vehicle on the stand, see p. 35 (POSITIONING THE VEHICLE ON THE STAND).
- ◆ Unscrew and remove the two screws (4).
- ◆ Remove the protection glass (5).



Upon reassembly, tighten the two screws (4) carefully, in order not to damage the protection glass.

- ◆ Press the bulb (6) slightly and rotate it anticlockwise.
- ◆ Extract the bulb from its seat.

 Insert the bulb in the bulb socket, making the two bulb pins coincide with the relevant guides on the socket.

- ◆ Correctly install a new bulb of the same type.

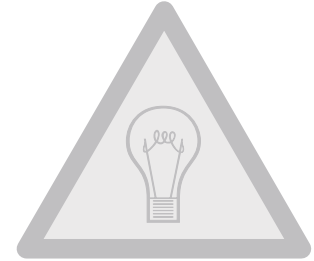

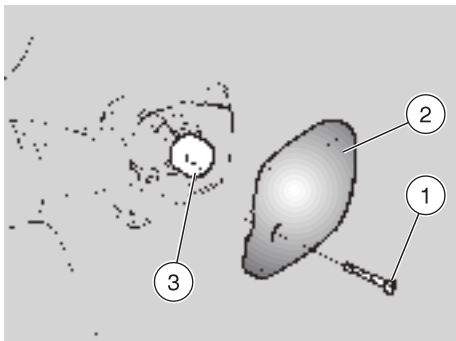

CHANGING THE REAR DIRECTION INDICATOR BULBS

Carefully read p. 58 (BULBS).

 Before changing a bulb, check the fuses, see p. 56 (CHANGING THE FUSES).

To change the bulbs, proceed as follows:

- ◆ Position the vehicle on the stand, see p. 35 (POSITIONING THE VEHICLE ON THE STAND).
- ◆ Unscrew and remove the screw (1).
- ◆ Remove the protection glass (2).



Upon reassembly, tighten the screw (1) carefully, in order not to damage the protection glass.

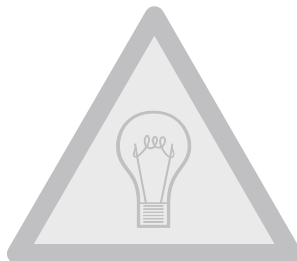

- ◆ Press the bulb (3) slightly and rotate it anticlockwise.
- ◆ Extract the bulb from its seat.

 **Insert the bulb in the bulb socket, making the two bulb pins coincide with the relevant guides on the socket.**

- ◆ Correctly install a new bulb of the same type.

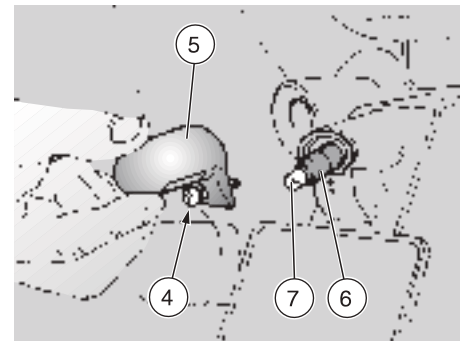

CHANGING THE NUMBER PLATE BULB

Carefully read p. 58 (BULBS).

 Before changing a bulb, check the fuses, see p. 56 (CHANGING THE FUSES).

To change the bulb, proceed as follows:

- ◆ Position the vehicle on the stand, see p. 35 (POSITIONING THE VEHICLE ON THE STAND).
- ◆ Unscrew and remove the screw (4).
- ◆ Remove the light unit (5).
- ◆ Extract the bulb socket (6).
- ◆ Withdraw the number plate bulb (7) and replace it with a new one of the same type.

TRANSPORT

 Before transporting the vehicle, it is necessary to empty the fuel tank and the carburettor completely, see beside (DRAINING THE FUEL TANK) making sure that both are completely dry.

During transport, the vehicle must be kept in vertical position, it must be firmly anchored and the 1st gear must be engaged, in order to avoid any leak of fuel, oil, coolant.

 In case of failure, do not tow the vehicle, but ask for assistance.

DRAINING THE FUEL TANK

Carefully read p. 21 (FUEL).

 Risk of fire. Wait until the engine and the exhaust silencer have completely cooled down. Fuel vapours are noxious for your health. Before proceeding, make sure that the room in which you are working is properly ventilated. Do not inhale fuel vapours. Do not smoke, nor use free flames.

DO NOT DISPOSE OF FUEL IN THE ENVIRONMENT.

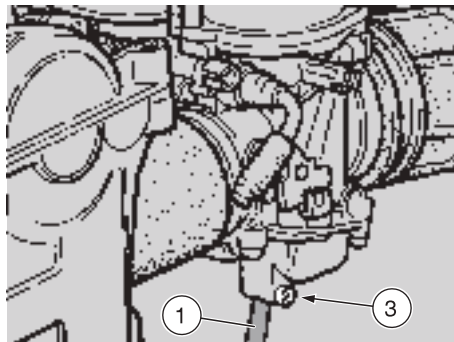

- ◆ Position the vehicle on the stand, see p. 35 (POSITIONING THE VEHICLE ON THE STAND).
- ◆ Stop the engine and wait until it has cooled down.
- ◆ Prepare a container with capacity exceeding the fuel quantity present in the tank and put it on the ground on the left side of the vehicle.
- ◆ Remove the filler cap.
- ◆ Empty the fuel tank by means of a manual pump or a similar system.

 After draining the tank, tighten the filler cap.



 The vehicle is provided with two carburettors. Carry out the emptying operations on both float chambers.

- ◆ To empty the float chamber, put the free end of the pipe (1) into a receptacle.
- ◆ Acting through the hole positioned on the frame (2), open the carburettor breather by loosening the drain screw (3).

When all the fuel has flowed out:

 Tighten the drain screw (3) carefully, to avoid fuel leaks from the carburettor breather pipe during refilling.

If necessary, contact an **aprilia** Official Dealer.

CLEANING

Clean the vehicle frequently if it used in particular areas or conditions, such as:

- ◆ Polluted areas (cities and industrial areas).
- ◆ Areas characterized by an high percentage of salinity and humidity (sea areas, hot and humid climates).
- ◆ Particular conditions (use of salt and anti-ice chemical products on the roads during the winter).
- ◆ Avoid leaving deposits of industrial and polluting powders, tar spots, dead insects, bird droppings, etc. on the body.
- ◆ Avoid parking the vehicle under trees, since in some seasons residues, resins, fruits or leaves fall down, which contain substances that may damage the paint.

 **After the vehicle has been washed, its braking functions could be temporarily impaired because of the presence of water on the grip surfaces. Calculate long braking distances to avoid accidents. Brake repeatedly to restore normal conditions.**

Carry out the preliminary checking operations, see p. 46 (PRELIMINARY CHECKING OPERATIONS).



To remove dirt and mud from the painted surfaces use a low- pressure water jet, carefully wet the dirty parts, remove mud and filth with a soft car sponge impregnated with a lot of water and shampoo (2 – 4% parts of shampoo in water).

Then rinse with plenty of water and dry with chamois leather. To clean the outer parts of the engine use a degreaser, brushes and wipers.

After washing the vehicle, always:

- ◆ Position the vehicle on the stand, see p. 35 (POSITIONING THE VEHICLE ON THE STAND).
- ◆ Remove the cap (1).
- ◆ Empty its content into a container and deliver it to a salvage centre.



To clean the lights, use a sponge soaked with water and a neutral detergent, rubbing the surfaces delicately and rinsing frequently with plenty of water.

Polish with silicone wax only after having carefully washed the vehicle.

Do not wash the vehicle under the sun, especially during the summer, when the body is still warm, since if the shampoo dries before being rinsed away, it can damage the paint.

Do not use liquids at a temperature exceeding 40°C to clean the plastic components of the vehicle. Do not direct high-pressure water or air jets or steam jets on to the following components: wheel hubs, controls on the right and left side of the handlebar, bearings, brake pumps, instruments and indicators, exhaust pipes, glove/tool kit compartment, ignition switch/steering lock, radiator wings, fuel cap, lights and electric connections.

Do not use alcohol or solvents to clean the rubber and plastic parts, the saddle and the headlight: use water and mild soap.



Do not apply protection waxes onto the saddle, in order not to make it too slippery.

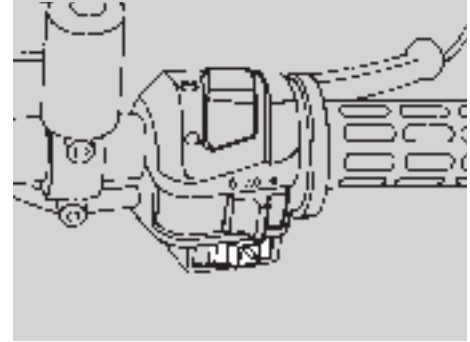
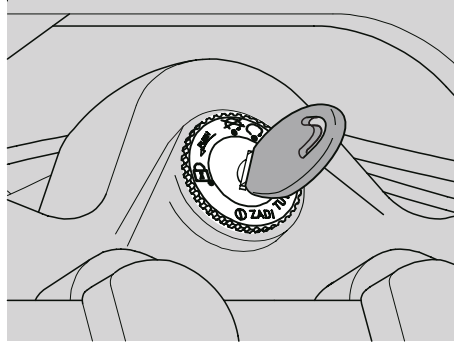

LONG PERIODS OF INACTIVITY

After a long period of inactivity of the vehicle some precautions are necessary to avoid any problem.

Further, it is important to carry out the necessary repairs and a general check up before the period of inactivity, since you could forget to carry them out later.

Proceed as follows:

- ◆ Drain the fuel tank and the carburetors, see p. 62 (DRAINING THE FUEL TANK).
- ◆ Extract the spark plug and pour a teaspoon (5-10 cm³) of engine oil into the cylinder. Move the ignition switch to position "0"; press the start push button "Ⓢ" for a few seconds, to distribute the oil evenly on the cylinder surfaces. Put back the spark plug.

- ◆ Remove the battery, see p. 55 (RECHARGING THE BATTERY).
- ◆ Wash and dry the vehicle, see p. 63 (CLEANING).
- ◆ Polish the painted surfaces with wax.
- ◆ Inflate the tyres, see p. 27 (TYRES).
- ◆ By means of a suitable support, position the vehicle so that both tyres are raised from the ground.
- ◆ Place the vehicle in an unheated, not-humid room, away from sunlight, with minimum temperature variations.
- ◆ Cover the vehicle avoiding the use of plastic or waterproof materials.

AFTER A PERIOD OF INACTIVITY



- ◆ Uncover and clean the vehicle, see p. 63 (CLEANING).
- ◆ Check the electrolyte level in the battery and install it, see p. 55 (LONG INACTIVITY OF THE BATTERY).
- ◆ Make sure that the fuel drain screw is thoroughly screwed (breather pipe closing index), see p. 62 (DRAINING THE FUEL TANK).
- ◆ Refill the fuel tank, see p. 21 (FUEL).
- ◆ Carry out the preliminary checking operations, see p. 29 (PRELIMINARY CHECKING OPERATIONS).



Have a test ride at moderate speed in a low-traffic area.



TECHNICAL DATA

DIMENSIONS	Max. length	2180 mm
	Max. width	880 mm
	Max. height (front part of the fairing included)	1265 mm
	Seat height	840 mm
	Distance between centres	1480 mm
	Min. ground clearance	200 mm
	Weight ready for starting	200 kg
ENGINE	Type	ROTAX 655 - one-cylinder, 4-stroke with 5 valves, 2 camshafts at the head, dry crankcase lubrication.
	Number of cylinders	1
	Total displacement	651,9 cm ³
	Bore / stroke	100 mm / 83 mm
	Compression ratio	9 ± 0,5 : 1
	Starting	electric
	Engine idling rpm	1400 ± 100 rpm
	Valve clearance (cold)	0.1 mm (intake) - 0.15 mm (exhaust)
	Clutch	multidisc in oil bath, with manual lever control on the left side of the handlebar.
	Cooling	liquid-cooled
CAPACITY	Fuel (reserve included)	22 ℓ
	Fuel reserve	5 ℓ (mechanical reserve) - 6 ℓ (electrical reserve).
	Engine oil	oil change 2150 cm ³ - oil and oil filter change 2200 cm ³ .
	Coolant	1.4 ℓ (50% water + 50% antifreeze with ethylene glycol)
	Seats	2
	Vehicle max. load (driver + passenger + luggage)	180 kg
	TRANSMISSION	Type

GEAR RATIOS	Ratio	Primary	Secondary	Final ratio	Total ratio
	1st	37/72 = 1 : 1.946	12/33 = 1 : 2.750	16 / 47 = 1 : 2,937	15.720
	2nd		16/28 = 1 : 1.750		10.003
	3rd		16/21 = 1 : 1.312		7.502
	4th		22/23 = 1 : 1.045		5.976
	5th		24/21 = 1 : 0.875		5.001
CARBURETTOR	Number.....			2	
	Model.....			Mikuni BST 33	
	Choke tube			Ø 31.5 mm	
FUEL SUPPLY	Fuel: - normal version.....			premium grade petrol (4 Stars ) according to the DIN 51600 standard, min. O.N. 98 (N.O.R.M.) and 88 (N.O.M.M.)	
	- version  			unleaded petrol according to the DIN 51607 standard, min. O.N. 95 (N.O.R.M.) and 85 (N.O.M.M.)	
FRAME	Type.....			Composite structure made of steel and alloy, with removable cradle and saddle pillar	
	Steering inclination angle			28°	
	Fore stroke			109 mm	
SUSPENSIONS	Front			hydraulically operated telescopic fork	
	Stroke			180 mm	
	Rear.....			hydraulic mono-shock absorber	
	Stroke			49 mm	
BRAKES	Front			disc brake - Ø 300 mm - with hydraulic transmission	
	Rear.....			disc brake - Ø 220 mm - with hydraulic transmission	
WHEELS	Type.....			aluminium with spokes	
	Front			2.15 19"	
	Rear.....			3.00 17"	
TYRES	FRONT			100 / 90 - 19 57 H	
	- alternative			100 / 90 - R19 57 H; 100 / 90 - 19 57 S; 100 / 90 - 19 57 T	
	- Inflation pressure for solo rider				
	- off-road			180 kPa (1.8 bar)	
	- asphalted road.....			180 kPa (1.8 bar)	
	- Inflation pressure for rider and passenger				
	- off-road			180 kPa (1.8 bar)	
	- asphalted road.....			180 kPa (1.8 bar)	

TYRES	REAR	130 / 80 - R17 65 H
	- alternative	140 / 70 - 17 66 H; 130 / 80 - 17 65 S; 130 / 80 - 17 65 T; 130 / 80 - 17 65 H
	- Inflation pressure for solo rider	
	- off-road	190 kPa (1.9 bar)
	- asphalted road	190 kPa (1.9 bar)
	- Inflation pressure for rider and passenger	
	- asphalted road	220 kPa (2.2 bar)
IGNITION	Type	CDI - Nippon Denso
	Standard spark plug	(Ø12 x 1.25) NGK DR8 EA - NGK DR8 ES
	Spark plug gap	0.6 ÷ 0.7 mm
ELECTRIC SYSTEM	Battery	12 V - 12 Ah
	Fuses	7.5 - 15 - 20 A
	Generator (with permanent magnet)	12 V - 280 W
BULBS	Low/high beam	12 V - 55 / 60 W
	High beam	12 V - 60 W
	Parking light	12 V - 3 W
	Direction indicators	12 V - 10 W
	Rear parking light/stoplight	12 V - 5 / 21 W
	Number plate light	12 V - 3 W
	Speedometer	12 V - 3 W
	Revolution counter	12 V - 2 W
	Coolant temperature indicator	12 V - 1.2 W
WARNING LIGHTS	Neutral indicator	12 V - 3 W
	Direction indicators	12 V - 3 W
	Low fuel	12 V - 3 W
	Engine oil pressure	12 V - 3 W
	Low beam	12 V - 3 W
	High beam	12 V - 3 W





LUBRICANT TABLE

engine oil (recommended):  SUPERBIKE 4, SAE 5W-40 or  4T FORMULA RACING, SAE 5W-40.

As an alternative to the recommended oil, it is possible to use high-quality oils with characteristics in compliance with or superior to the CMC G-4, A.P.I. SG specifications.

fork oil (recommended):  F.A. 5W or  F.A. 20 W fork oil;

as an alternative  FORK 5W or  FORK 20W fork oil.

If you need an oil with intermediate characteristics in comparison with the  F.A. 5W and  F.A. 20 W or  FORK 5W and  FORK 20W, these can be mixed as indicated below:

AE 10W =  F.A. 5W 67% of the volume, +  F.A. 20W 33% of the volume or
 FORK 5W 67% of the volume +  FORK 20W 33% of the volume.

AE 15W =  F.A. 5W 33% of the volume, +  F.A. 20W 67% of the volume or
 FORK 5W 33% of the volume +  FORK 20W 67% of the volume.

bearings and other lubrication points (recommended):  AUTOGREASE MP or  GREASE 30.

As an alternative to the recommended product, use high-quality grease for rolling bearings, working temperature range -30 °C...+140 °C, rippling point 150 °C...230 °C, high protection against corrosion, good resistance to water and oxidation.

protection of the battery poles: neutral grease or Vaseline.

prayer grease for chains (recommended):  CHAIN SPRAY or  CHAIN LUBE.

WARNING

Use new brake fluid only.

brake fluid (recommended):  F.F., DOT 5 (compatible with DOT 4) or  BRAKE 5.1, DOT 5 (compatible with DOT 4).

WARNING

Use only antifreeze and anticorrosive without nitrite, ensuring protection at -35 °C at least.

engine coolant (recommended):  ECOBLU -40 °C or  COOL.

NOTE

aprilia

ASK FOR GENUINE SPARE PARTS ONLY

Importers

I APRILIA s.p.a. via G. Galilei, 1 - 30033 Noale (VE) Italy
Tel. +39(0)41 5829111 - Fax +39(0)41 441054 - Servizio Clienti **aprilia** +39(0)41 5786269

F APRILIA WORLD SERVICE B.V. Z.A. Central Parc - 255 BLD Robert Ballanger
B.P. 77- 93421 Villepinte (F) - Tel. (0) 149634747 - Fax (0) 149638750

D MOTORRAD GmbH Am Seestern 3 D-40547 Düsseldorf (D)
Tel. (211) 59018-00 - Fax (211) 5901819

E APRILIA WORLD SERVICE B.V. ESPAÑA Calle Alcorcon 19 - 28850 Torrejón de Ardoz - Madrid (E)
Tel. (91) 6778083 - Fax (91) 6778577

NL APRILIA NEDERLAND Nikkelstraat 1 - 4823 AE Breda (NL)
Tel. (076) 5431640 - Fax (076) 5431649

UK APRILIA MOTO U.K. LTD. Dunragit - Stranraer - Wigtownshire DG9 8PN - Scotland (UK)
Tel. (01776) 888670 - Fax (01581) 400661

USA APRILIA USA Inc. 110 Londonderry Court, Suite 130 - Woodstock, GA 30188 (USA)
Tel. 770 592 2261 - Fax 770 592 4878

A GINZINGER IMPORT GmbH & CO Frankenburgerstrasse 19 - 4910 Ried im Innkreis (A)
Tel. (7752) 88077 - Fax (7752) 70684

P MILFA IMPORTAÇÃO EXPORTAÇÃO LDA. Avenida da Republica 692 - 4450-238 Matosinhos (P)
Tel. 229382450 - Fax 229371305

SF TUONTI NAKKILA OY P.o.B. 18 - 29250 Nakkila (SF)
Puh. (02) 5352500 - Fax (02) 5372793

B RAD n.v. / s.a. Industriegebied - Landegemstraat 4 - B - 9031 Drogen-Baarle
Tel. (09) 2829410 - Fax (09) 2829433

GR MOBILITY S.A. av. Messogion 191 - 11525 Athens (GR)
Tel. (1) 6728705 - Fax (1) 6728727

GR MOBILITY A.E. Λ. Μεσογειων 191 - 115-25 Αθηνα - Ελλάδα
Τηλ. (1) 6728705 - Φαξ: (1) 6728727

CH MOHAG AG Bernerstrasse Nord 202 - 8064 Zurich (CH)
Tel. (1) 4348686 - Fax (1) 4348606

DK S T.M.P. Islandsvej 3 - 7900 Nykøbing Mors (DK)
Tel 97722233 - Fax 97722133 - E-mail: t_m_p@post4.tele.dk

J BOSCO MOTO CO. LTD. 22-25 Hakunoshima 2 Chome Minoo-Shi 562 Osaka
562-0012 OSAKA (J) - Tel. (0727) 253311 - Fax (0727) 253322

J 株式会社 栄人コモモ 〒162 0312 大塚新町西中田ビル 2F 929 96
東京 03-2725-3311 FAX : 03-2725-3322

SGP IDEAL MOTOR SPORT PTE. LTD. 20 MacLaggart Road, #01-01 Khong Guan Industrial Building 368079 Singapore (SGP)
Tel. 2820082 - Fax 2821012

Importers

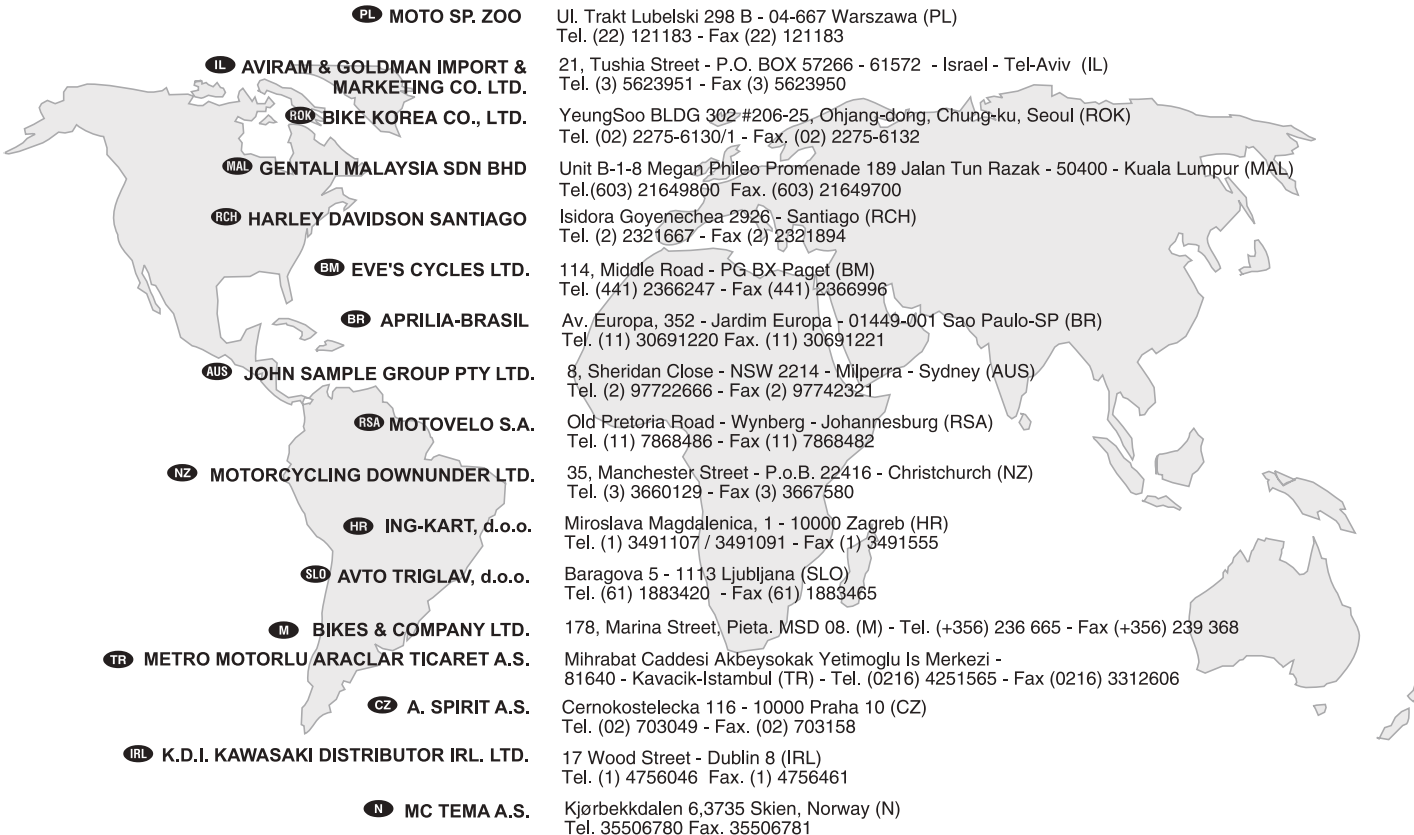

(PL) MOTO SP. ZOO	Ul. Trakt Lubelski 298 B - 04-667 Warszawa (PL) Tel. (22) 121183 - Fax (22) 121183
(IL) AVIRAM & GOLDMAN IMPORT & MARKETING CO. LTD.	21, Tushia Street - P.O. BOX 57266 - 61572 - Israel - Tel-Aviv (IL) Tel. (3) 5623951 - Fax (3) 5623950
(ROK) BIKE KOREA CO., LTD.	YeungSoo BLDG 302 #206-25, Ohjang-dong, Chung-ku, Seoul (ROK) Tel. (02) 2275-6130/1 - Fax. (02) 2275-6132
(MAL) GENTALI MALAYSIA SDN BHD	Unit B-1-8 Megan Phileo Promenade 189 Jalan Tun Razak - 50400 - Kuala Lumpur (MAL) Tel.(603) 21649800 Fax. (603) 21649700
(RCH) HARLEY DAVIDSON SANTIAGO	Isidora Goyenechea 2926 - Santiago (RCH) Tel. (2) 2321667 - Fax (2) 2321894
(BM) EVE'S CYCLES LTD.	114, Middle Road - PG BX Paget (BM) Tel. (441) 2366247 - Fax (441) 2366996
(BR) APRILIA-BRASIL	Av. Europa, 352 - Jardim Europa - 01449-001 Sao Paulo-SP (BR) Tel. (11) 30691220 Fax. (11) 30691221
(AUS) JOHN SAMPLE GROUP PTY LTD.	8, Sheridan Close - NSW 2214 - Milperra - Sydney (AUS) Tel. (2) 97722666 - Fax (2) 97742321
(RSA) MOTOVELO S.A.	Old Pretoria Road - Wynberg - Johannesburg (RSA) Tel. (11) 7868486 - Fax (11) 7868482
(NZ) MOTORCYCLING DOWNUNDER LTD.	35, Manchester Street - P.o.B. 22416 - Christchurch (NZ) Tel. (3) 3660129 - Fax (3) 3667580
(HR) ING-KART, d.o.o.	Miroslava Magdalenica, 1 - 10000 Zagreb (HR) Tel. (1) 3491107 / 3491091 - Fax (1) 3491555
(SLO) AVTO TRIGLAV, d.o.o.	Baragova 5 - 1113 Ljubljana (SLO) Tel. (61) 1883420 - Fax (61) 1883465
(M) BIKES & COMPANY LTD.	178, Marina Street, Pieta. MSD 08. (M) - Tel. (+356) 236 665 - Fax (+356) 239 368
(TR) METRO MOTORLU ARACLAR TICARET A.S.	Mihrabat Caddesi Akbey Sokak Yetimoglu Is Merkezi - 81640 - Kavacik-Istambul (TR) - Tel. (0216) 4251565 - Fax (0216) 3312606
(CZ) A. SPIRIT A.S.	Cernokostelecka 116 - 10000 Praha 10 (CZ) Tel. (02) 703049 - Fax. (02) 703158
(IRL) K.D.I. KAWASAKI DISTRIBUTOR IRL. LTD.	17 Wood Street - Dublin 8 (IRL) Tel. (1) 4756046 Fax. (1) 4756461
(N) MC TEMA A.S.	Kjorbekkdalen 6,3735 Skien, Norway (N) Tel. 35506780 Fax. 35506781

WIRING DIAGRAM KEY - Pegaso 650

- 1) Direction indicator warning light
- 2) High beam warning light
- 3) Parking light warning light
- 4) Engine oil pressure warning light
- 5) Dashboard bulbs
- 6) Neutral indicator warning light
- 7) Low fuel warning light
- 8) Coolant temperature indicator
- 9) Dashboard
- 10) Left dimmer switch
- 11) Right dimmer switch
- 12) Ignition switch
- 13) Blinking
- 14) Rear right direction indicator
- 15) Rear light
- 16) Rear left direction indicator
- 17) Neutral switch
- 18) Rear stoplight switch
- 19) Front stoplight switch
- 20) Coolant temperature thermistor
- 21) Cooling electrofan thermal switch
- 22) Starter
- 23) Start relay
- 24) Battery
- 25) Voltage regulator
- 26) Generator
- 27) CDI
- 28) Spool
- 29) Diode 1
- 30) Front left direction indicator
- 31) Pick up
- 32) Low/high beam bulb
- 33) Front parking light
- 34) Front right direction indicator
- 35) Horn
- 36) Headlight
- 37) Cooling electrofan
- 38) Spark plug
- 39) Fuses
- 40) Engine oil pressure sensor
- 41) Multiple connectors
- 42) Diode 2
- 43) Dashboard resistance
- 44) Switch on the clutch lever
- 45) Spark advance resistance
- 46) Low fuel sensor
- 47) Side stand switch
- 48) High beam bulb
- 49) Light relay
- 50) Number plate light
- 51) Stoplight/parking light bulb

CABLE COLOURS

- Ar** Orange
Az Light blue
B Blue
BI White
G Yellow
Gr Grey
M Brown
N Black
R Red
V Green
Vi Violet

aprilia s.p.a. wishes to thank its customers for the purchase of this vehicle.

- Do not dispose of oil, fuel, polluting substances and components in the environment.
- Do not keep the engine running if it isn't necessary.
- Avoid disturbing noises.
- Respect nature.