

aprilia

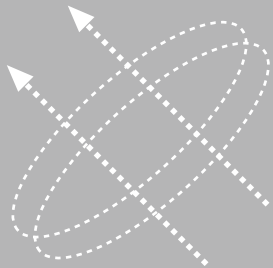

use and maintenance

Tables of contents

SAFE DRIVING	2
GENERAL FEATURES	6
MAIN INDEPENDENT CONTROLS	10
MAIN COMPONENTS	19
INSTRUCTIONS FOR USE	23
RECHARGEMENT	28
MAINTENANCE	31



enjoy racing



enjoy city

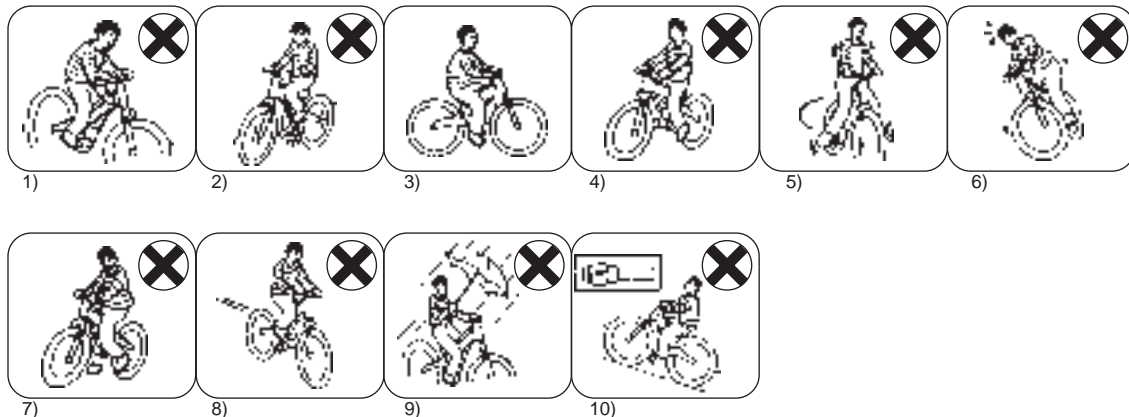

DRIVING SAFELY

- 1) Don't turn the key while riding.
- 2) Check the bike when noise is heard during riding. Call for service from Aprilia authorized dealer if problems remain unsolved.
- 3) For the bicycle correct operation and for safety reasons we suggest that it be used by only one person per time.
- 4) Don't overload or carry anything which obscure your view.
- 5) Don't ride when drinking.
- 6) Make sure the bicycle is in vertical position before you start riding to avoid falling.
- 7) Don't try to operate the dynamo with one leg, and pedal with the other. This may cause danger or injury.
- 8) Don't pedal too hard when power assistance from motor is declining on a downhill run.
- 9) Avoiding riding the bicycle with an open umbrella in the rain.
- 10) Don't touch the motorkit after travel; the temperature could be very high.
- 11) **WARNING!** The bike is provided with an electric safety system that stops the electric assistance to prevent improper use. (For example uphill riding using the highest gear and increasing too much the human pressure on pedal).

Do not adjust the adjusting screw of the rear derailleur by yourself to avoid damaging the gear shifting mechanism or causing technical troubles.

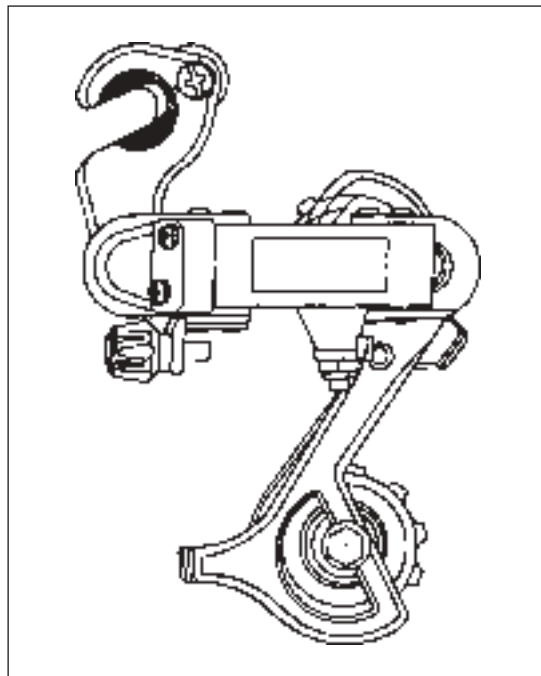

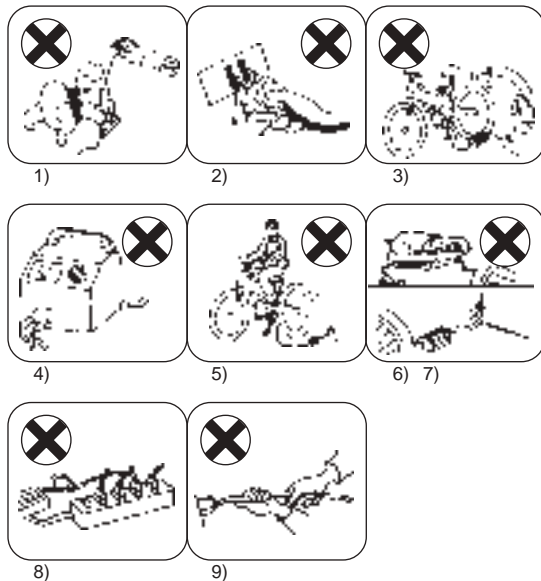

Please pay special attention to the following when recharging.

- 1) Keep children away from recharging equipment and avoid electric cables entanglement.
- 2) To avoid shock, don't plug in with wet hands or when the electrical components are damp. Moreover, prevent the charger from coming into contact with water.
- 3) Don't clean the bike with water when recharging.
- 4) For longer battery life, use genuine **aprilia** equipment for recharging. Check that there is enough ventilation to avoid overheating the charger.
- 5) Don't ride on and pedal the bike when recharging to avoid falling or serious damages to the charger.
- 6) Don't put clothes over the tackle when recharging.
- 7) Be sure the cable won't be squeezed when re-charging to prevent short circuit.
- 8) Be sure to use single outlet socket.
- 9) Never disconnect the plug by pulling the cable.

GENERAL FEATURES

BIKE COMPONENTS

- 1) FRONT WHEEL
- 2) FRONT SUSPENSION FORK
- 3) FRONT MUDGUARD
- 4) FRONT BRAKE
- 5) FRONT LAMP
- 6) BRAKE LEVER
- 7) GRIP SHIFT
- 8) FUNCTION SWITCH
- 9) STEM
- 10) HANDLEBAR
- 11) STEERING SET
- 12) LED INDICATOR
- 13) BATTERY SET
- 14) RECHARGE COVER
- 15) PILLAR
- 16) PILLAR LOCK
- 17) SIDE GUARD
- 18) DYNAMO

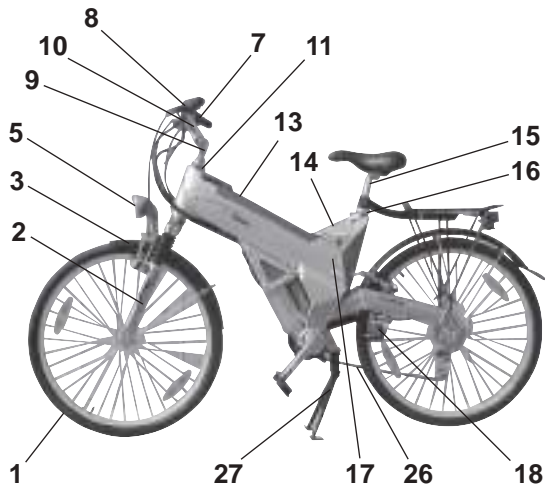

NOTE: ENJOY RACING VERSION IS WITHOUT ITEMS N°
3,5,18,22,23,24

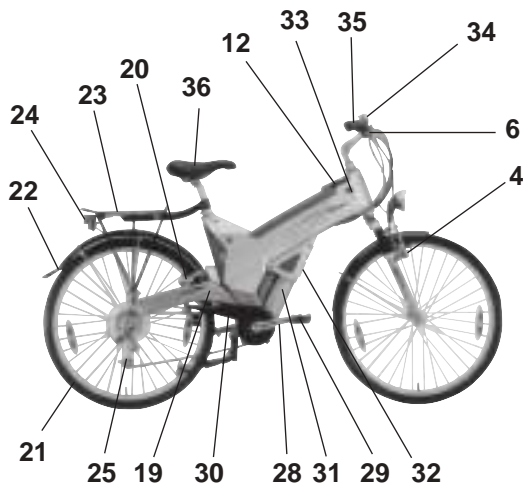

- 19) FRAME
- 20) REAR BRAKE
- 21) REAR WHEEL
- 22) REAR MUDGUARD
- 23) CARRIER
- 24) REAR LAMP
- 25) REAR DERAILLEUR
- 26) CHAIN
- 27) KICK STAND
- 28) CRANK
- 29) PEDAL
- 30) CHAIN GUARD
- 31) MOTOR KIT
- 32) CONTROLLER
- 33) LOCK POWER SWITCH
- 34) BELL
- 35) GRIP
- 36) SADDLE

SPECIFICATION

Model name	Aprilia Enjoy City	Aprilia Enjoy Racing
Weights /dimensions		
Empty Weight, depending on fitting	Approx. 30.5 kg	Approx. 29.2 kg
Permissible total weight	Max. 130 kg	Max. 130 kg
Permissible load on carrier	Max. 10 kg	Max. 10 kg
Dimensions (L x W x H)	Approx. 1760x580x1040 mm	Approx. 1760x570x1180 mm
Frame	Alloy 7005	Alloy 7005
Front/rear tyre	47-559 (26"x1.75")	51-559 (26"x1.90")
Front/rear rim	20x559	18x559
Front tyre pressure	3.0 bar max.4.5 bar	3.0 bar max.4.5 bar
Rear tyre Pressure	3.5 bar max.4.5 bar	3.5 bar max.4.5 bar
Drive		
Tread drive	Pedal, crank length 170 mm	Pedal, crank length 170 mm
Gear shift	6 speed shimano and Sram grip	6 speed shimano and Sram grip
Distance per crank revolution		
Long ratio (6 th speed)	8.75 m	8.75 m
Short ratio (1 st speed)	3.6 m	3.6 m

Model name	
Motor drive unit	d.c. motor 24V/250W
Power control	Electronically controlled via torque and pedal speed sensor
Drive	d.c. commutator motor
Power assistance ratio	Max. up to 20 Km/h, falling linearly to 24 Km/h
Power assistance	Max. 220 W
Gearbox, power transmission	Planetary gear assembly and chain
Total transmission ratio	1:22.7
Battery	20 Nickel-Hidrate metal cells at 1.2 V = 24 V
Peak current	70 A
Nominal capacity	13 Ah
Fuse	2x30 A and 2x5 A
Resistance	NTC 10 Kohm
Weight	5.5 Kg
Range	Up to 40 Km depending on the level of power assistance, charging condition of the battery, level or hilly route, opposing wind, loading, road surface wear, air pressure etc.
Life	Min. 500 chargings with completely discharged battery, correspondingly more with partly discharged battery

MOTOR KIT

More unique features **aprilia** cycle is its Motor Kit design, such as Dual-Sense module (torque sensor+speed sensor), enhanced

computerized controller, spiral bevel gearing drivetrain system, etc.

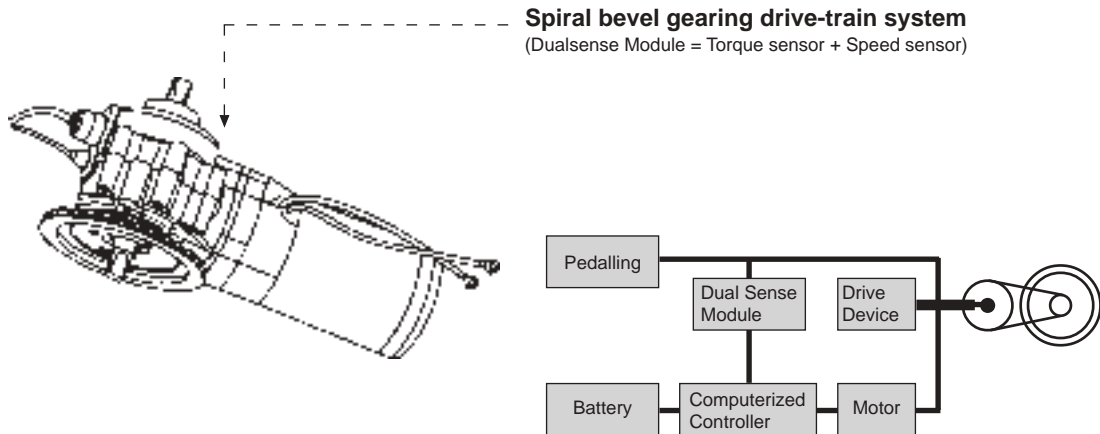

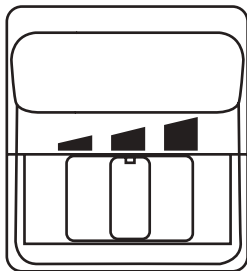

FUNCTION	DRIVING FUNCTION	Remarks
LEFT	ECO	
MIDDLE	NORMAL	
RIGHT	UP_HILL	

FUNCTION SWITCH

As illustrated above, it is a 3-mode switch, which has left, middle, and right positions.

The function and definition of the switch

ECO

An economic mode in lower power assisting, the assistance will be automatically off when the speed reaches about 24km/hr.

NORMAL

The normal power assistance mode, the assistance is off at a speed of about 24km/hr.

UP_HILL

A mode in stronger power assistance than the NORMAL position. The assistance will be automatically off when the speed reaches about 24km/hr.

LOCK POWER SWITCH

Features

There are 3 positions for the key:

1. position "OFF": With key turned to this position, the power supply is switched off, but the battery set is still locked on the body of the bike.
2. position "ON": the power is switched on and the battery set is also locked.
3. position "OPEN": The power is off, and the battery set is unlocked so that you can remove the battery set from the bike. Moreover, the OPEN position enables you to put the battery set back onto the bike.

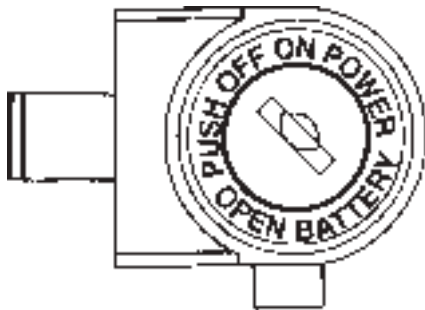

BRAKE SWITCH

1. When you are not braking, please make sure the brake levers (Right & Left) are on the right positions. Otherwise, it may cut off the power and result in no power assistance.
2. When you brake, the brake switch will cut off the power.
3. If the wire of the brake switch is broken, there will be no power assistance.
4. If the connectors inside the brake bracket are broken or loosen, there will be no power assistance.

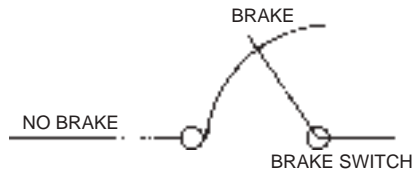
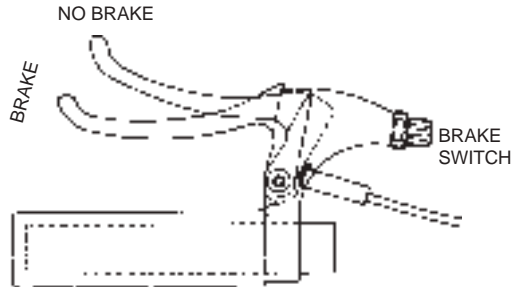

CHARGER DESCRIPTION

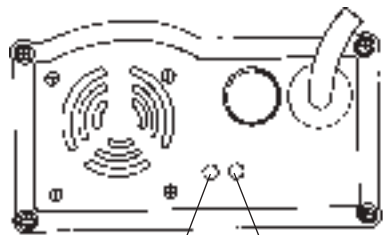

RED LED

ORANGE LED
(YELLOW)

SWITCH ON-OFF

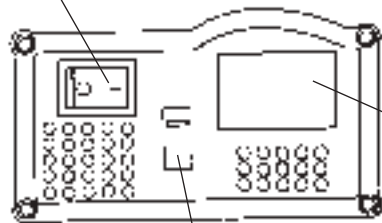

VOLTAGESWITCH

POWER
CONNECTOR

CHARGE
CONNECTOR

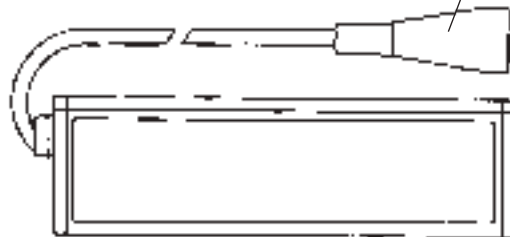

1. Specification

Item	Specification
Output Current	4Adc \pm 5%
Output Voltage	32.0Vdc \pm 2%
Input Current	2.0A
Input Voltage	100-120 Vac Or 200-240 Vac (Manual Select)
Performance	Switching Mode
Charging Method	Two Stage Constant Current
Battery Application	Ni-MH Batteries (1.2V a 20 Cells 13000mAh)
Output Detection	1. Short Circuit Detection 2. Output Voltage Current Limit 3. Reverse Power Protected 4. Overheat Detection On Battery And Charger 5. Charging Time Limit
Operating Temperature	0°C ~ 35°C
Operating Humidity	20% ~ 85%

2. Operating Instruction

- 1) Manually adjust the correct input voltage (115V/230V).
- 2) Connect the plug of battery charger to the socket of battery.
- 3) Plug in the power cord and turn on the power switch. LED (POWER) shows RED when AC current passes.
- 4) Charging starts as ORANGE light means charging and GREEN means fully charged.

3. LED Indication

LED(POWER) - RED LIGHT ON: Power On
A LED(CHARGE) - LIGHT OFF: Battery Disconnect
ORANGE LIGHT FLASH: Abnormal or waiting to start
ORANGE LIGHT ON: Charging
GREEN LIGHT ON: Fully Charged

5. Trouble Shooting

- (1) If LED(POWER) light is off
 - Check the input voltage (115V/230V) is the same as you adjust.
 - Check the AC fuse. If broken, please replace the spare one.
 - Check AC passing is in normal condition.
 - If light is still off, please have the battery charger to be recovered.
- (2) If LED(CHARGE) light is off
 - Check the plug of battery charger and socket of battery is correctly connected.
 - Check the DC fuse. If broken, please replace the spare one.
 - If light is still off, the battery may be defective.
- (3) If ORANGE light flashes
 - The battery temperature is too high to start with recharge process.
- (4) If ORANGE light turns to GREEN immediately
 - The battery may be in well-charged condition.
 - If the LED indicator signals that the battery is not fully charged, it may be defective. Please have it to be recovered.

6. Caution

- (a) To prolong charger life, do not connect the short output for long time.
- (b) Use the charger in a well-ventilated area.
- (c) Use for Ni-MH (1.2V, 20 cells, 13000mAh) batteries only.
- (d) Make sure AC voltage input and select correctly (115V/230V) before charging.
- (e) After fully charged, avoid reconnect the battery with battery charger to overcharging.
- (f) Use the Charger with an ambient temperature lower than 35°C.

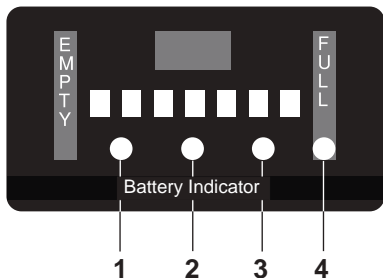

○ ○ ○ ●	FULL CHARGE
○ ○ ● ○	MEDIUM CHARGE
○ ● ○ ○	LOW CHARGE
● ○ ○ ○	EMPTY
☀ ○ ○ ○	COMPLETELY DOWN

LED INDICATOR FUNCTIONS

The led indicator may display a charge which is too low when:

- The ambient temperature is too low
- The driving conditions are very hard (e.g. during a strong up-hill)

A charge which is too high may be displayed a few minutes after recharge, when:

- The battery has only been 1/2 charged

LED INDICATOR FUNCTIONS AND SOUND ALARMS

Item	Indicator	Buzzer Alarm	Condition	Solution
1	●○○○ 1 st indicator is always ON. ON:0.8S,OFF:0.2S	Continuous intermittent alarm	The battery voltage is too low	Charge the battery.
2	●○○○ 1 st indicator is always ON. ON:0.3S,OFF:0.2S	Continuous intermittent alarm	The battery middle is too low	Charge the battery.
3	“●”○○○ 1 st indicator is flashing. ON:0.5S,OFF:0.2S	Three short warning alarms then stop warning	Electrical components failure	Call the aprilia. dealer
4	“●”○○○ 1 st indicator is flashing. ON:0.5S,OFF:0.2S	Continuous intermittent alarm	Over current warning	Switch off, then switch on then switch If the alarm stops: Overcurrent happened, please use a lower gear If the alarm is keeping: Call the aprilia dealer

SHIFTING

Function and Operation/The Derailleur System

The word derailleur refers to the derailing or shifting of the chain from one sprocket to another. The derailleur system includes rear derailleurs, the shift levers, and the cables. A variety of gear ratios allows you to maintain a constant rate of pedal revolutions in spite of changes in terrain, climatic conditions and your physical condition.

Never attempt to shift gears when stopped or when back pedalling. When you shift, reduce your pressure on the pedals; excessive chain tension makes shifting difficult. Avoid shifting when going over railroad tracks or other bumpy surfaces, or the chain may not shift properly and may come off.

The GRIP-SHIFT, Figure 4, are operated by GRIPSHIFT control. right-hand GRIP controls the rear derailleur. Choose the gear combination most comfortable for the road conditions, and you should be able to maintain a constant rate of pedalling. It is not essential that various gear combinations be used in sequence.

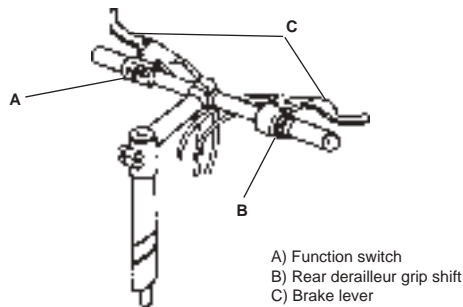

Figure 4, Shift Levers Grip Shift

A properly adjusted drivetrain and derailleur system is quiet. If an unusual noise accompanies or follows any shift, try moving the GRIPSHIFT slightly. If the noise persists or grows louder, stop the bicycle and try to locate the noise. If necessary, ask your **aprilia** dealer to identify and correct any problems.

Cleaning and lubrication of the chain

Keep the chain as free of dirt as possible. After cleaning with a chain cleaning set, allow the chain to air dry and then apply the proper bicycle oil. Keep in mind that excessive oil on the chain will attract more dirt.

Carefully apply oil only to the pivot points of each link.

Cleaning of the freewheel

The freewheel should be kept as clean as possible. Remove the surface dirt that gathers around the cog with solvent and a brush. Do not use gasoline.

To clean and lubricate the bearings, remove the freewheel unit from the hub.

Adjustment

Check that the derailleurs have been properly adjusted if:

- shifting is sluggish or difficult
- you hear a rubbing or grinding noise
- the chain rubs on any part of the bicycle or falls off during or after a shift.

The rear derailleur (Figure 5) should be checked and adjusted by your **aprilia** dealer first.

Removal of spoke protector may cause technical troubles. Apply to an Authorized **aprilia** Service Center.

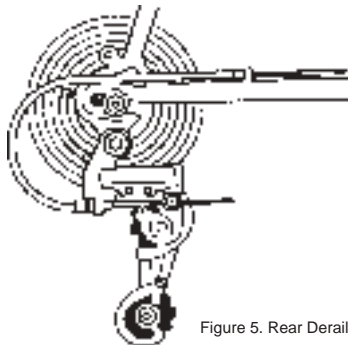

Figure 5. Rear Derailleur

WHEEL

Inspect your wheels frequently to make sure that there are no loose,damaged,or broken spokes.

Remember:If a wheel is not in good condition, both the range, the effectiveness of the brakes and the strength of the wheel are greatly reduced.

Tire Inspection

Keep your tires inflated to the pressure molded on the tire sidewalls.Use a gauge and a bicycle pump whenever possible.

Avoid filling your tires at gas stations; because of the greater pressure and volume of air their pumps release,blowouts are very possible.

When you fill your tires,check to see that each tire is properly seated in the rim and that there are no defects on its surface.If a tire shows signs of excessive wear, dry rot, or if it is badly cut, replace it as soon as possible.

QUICK RELEASE

Quick Release Hubs

Some wheels are provided with quick release hubs. These allow you to remove and install the wheel without the use of tools. To release, pull the lever out away from the hub. To tighten, press the lever back toward the hub.

Caution: Be sure that hub quick release lever is firmly in the engaged position, and that wheel is firmly locked into the frame before riding.

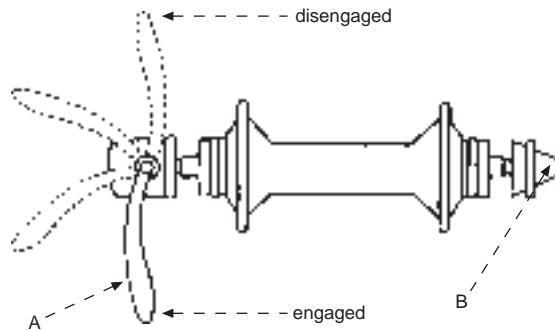

Figure 12. Hub Quick Release

A) Skewed lever

B) Adjusting nut

INSTRUCTION FOR USE

PREPARATION BEFORE RIDING INTRODUCTION OF FUNCTIONS

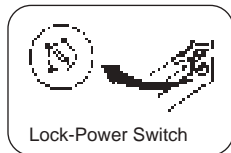

Lock-Power Switch

- 1) Push the key down temporarily and then turn the key to "ON" while riding. The indicator will indicate the battery charge level.
- 2) Turn the key to "OPEN" to remove the battery set for recharging or replacement.
- 3) Turn the key to "OPEN" to put the battery set back on the bike.
- 4) Turn to "OFF" and take the key out when not in use.

Lift the gear shift lever

- 1) Uphill riding, please use 1st gear.
- 2) Headwind riding, please use 2nd gear.
- 3) Normal riding and starting, please use 3.4.5 gear.
- 4) Speedy riding, please use 6th gear.
- 5) Don't apply too much pressure on the pedals when shifting.

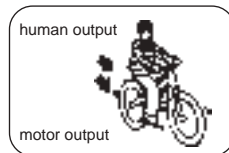
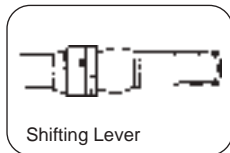

Pedal Control

- The motor output is controlled by the pedaling force and the speed.



Recharging Socket

- Recharging socket is available under the recharge cover. On-bike recharging can be done from this socket. Check that the ignition lock key is turned to OFF during the recharging operation.

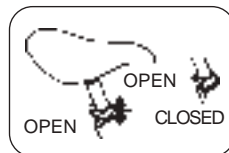

Seat Height

- The height of the seat can be adjusted. Before riding, always ensure that the seat clamp screw has to be fixed.



Controller

- Fuse on the back side of battery case protect the Controller.

CHECK-LIST BEFORE RIDING

To ensure a safe and comfortable ride, please check the following items before riding:

- 1) The range of a fully charged Aprilia battery under normal riding condition is approximately 25km~40km. However, the range will vary depending on a variety of factors such as terrain, battery condition, tyre pressures, general conditions and load of bicycle.

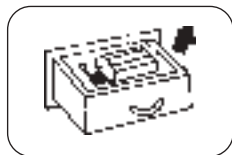

- 2) Check that the charger has been properly stored.

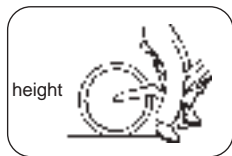

- 3) Check that the seat been properly adjusted according to the height of rider.



- 4) Check the brake function. Make sure the **aprilia** won't move when applying the brake lever to 1/2 of the reach.

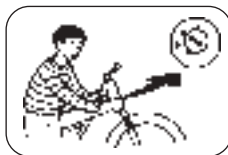

- 5) Check that the battery firmly located onto the bike.

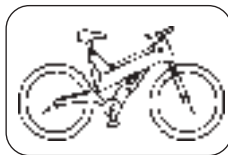

- 6) Check all the bolts tightening (seat, wheels, steering set and handlebar stem).



- 7) Check the tyre pressures and inflate if necessary.
Corporeal weight: 65 kg
(L) ~130 -140 mm

BRIEF INSTRUCTION ON STARTING

1) Lock-Power Switch (On-Off-Open)-



ON: Power is on and the bike is ready to ride.

OFF: Power is off and the battery can be recharged.

OPEN: The battery can be removed, but first the key has to be pushed down and released again.

2) Indicating Light-

Normal: When the key is turned to "ON", the bike will give off a sound. All 4 indicators will flash for a short (check with cast controller function!) moment and then one remains on to indicate the relevant battery charge level.

LED 2): The battery needs recharging.

LED 1): Battery has run down.

Malfunction! one Indicator keeps flashing and there is warning sound.

3) Release the kickstand before riding.

4) Familiarise yourself with your bicycle and its controls before you attempt to ride in traffic.

5) To start, simply apply pressure to the pedals.





1)

2)

3)



4)

5)

6)



7)

8)

9)

DRIVING INSTRUCTIONS

- 1) Flashing (1) light signals low battery. Recharging is required.
- 2) Indicator (1) signals empty battery. The controller will cut power supply to the motor and pedaling becomes harder. Battery recharging is required.
- 3) Malfunction of motor or reduction gear may cause noise when riding. Please check and call for service.
- 4) If battery case falls into water, dry it out and call for check from dealer before riding.
- 5) Stop riding when motor gets wet. Call for check from **aprilia** dealer before riding.
- 6) Don't ride when battery case is broken. Replace the case at your dealers shop.
- 7) Find a proper parking place.
- 8) Turn key to "OFF" position and take the key out when not in use.
- 9) Extra lock required to prevent theft.

RECHARGEMENT

SAFELY RECHARGEMENT

Charging with wrong charger will damage the battery & may cause danger!

Please follow the specified charge conditions.

The battery must be recharged before first use and after each use.

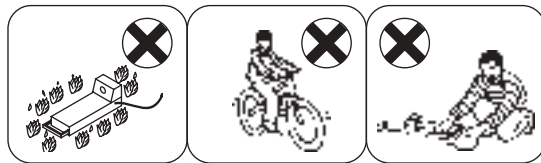

1)

2)

3) 4)

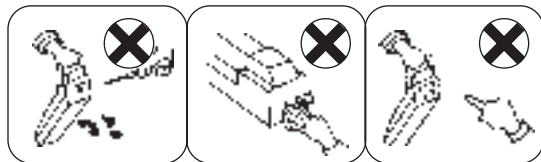

5)

6)

7)

- 1) Don't put the battery on the fire as it may explode.
- 2) To ensure the performance of the battery, please recharge the battery after each use using only **aprilia** original equipment.
- 3) Don't disconnect from the mains until the indicator light changes from orange to green.
- 4) Leaving the battery not fully charged will result in the deterioration of the battery performance. Make sure it is always fully charged.
- 5) Don't try to dismantle the battery set.
- 6) Don't grind the electrode connectors. Clean with a dry cloth if necessary.
- 7) Don't deform the electrode metal plates as this may cause contact failure.
- 8) In case of prolonged stops (about 1 month), remove the battery from the bicycle and store it in a separate place.

To prevent battery deterioration it must be recharged at least every three months especially when in storage.

RECHARGING PROCEDURE

Recharging can be done either by plugging direct into the socket located in the frame, or by removing the battery case and placing it in the recharging equipment. Recharging time is about four hours. For maximum economy, we recommend that you recharge at night during off-peak hours.

1. Proper place for recharging

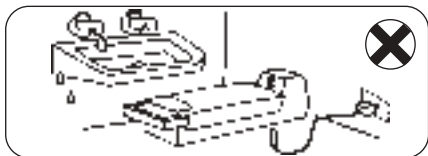

1). Indoor: Avoid high temperature and humidity.

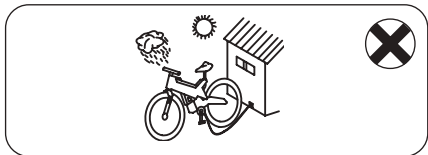

2). Outdoor: Avoid sunshine or rain.

2. Off-bike recharging

- 1) Park the bike
- 2) Turn the key to "Open" (Push and release first) and unpack the battery case.
- 3) Oper the open cover pushing both sides.
- 4) Pull the HANDLE to take out the battery case.

Warning! when pull-out the battery pay attention to don't touch the led indicator.
- 5) Put the charger plug into the socket of the battery.
- 6) Verify that the voltage is the right one (FOR EUROPE 220V)
- 7) Plug the socket into the mains outlet.
switch on the charger

- 8) If the charger indicating led is not lit, it is abnormal. Please check or call for service from dealer.
- 9) Recharging should not be undertaken under the following conditions:
 - a) Immediately after riding, when the battery temperature has risen. Please wait until the battery returns to its normal temperature.
 - b) When the temperature of the battery is Over 35°C (Ambient Temperature)
 - c) In an area where the temperature is below 0°C. Please find a warmer place.

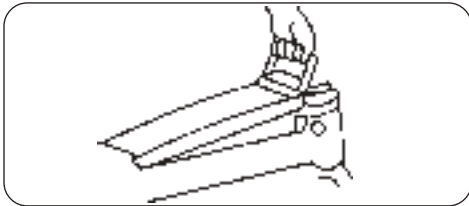

- 10) When the indicating light of the re-charger turns from yellow to green color, it signals the re-charging has been done fully. At this time, the electric current of the re-charger will automatically become smaller and there will be no danger even though the plug is still connected to the mains outlet.

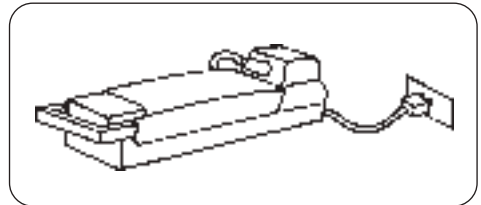

3. After recharging

- 1) Ensure there are no other objects inside the battery cover on either side of the frame.
- 2) Turn the key to "OPEN" position.
- 3) Push in the battery set and have it firmly locked with the locking device.
- 4) Make sure the battery case is firmly located before riding.

4. On-bike recharging

- 1) Turn the key to "Off" position.
- 2) Turn dust cap aside and plug charger cable in the connector.
- 3) Same procedures as 2-(6)(7)(8)(9)(10).
- 4) After recharging, remove the charger plug and put the connector cap in the original position. Close the recharge cover.

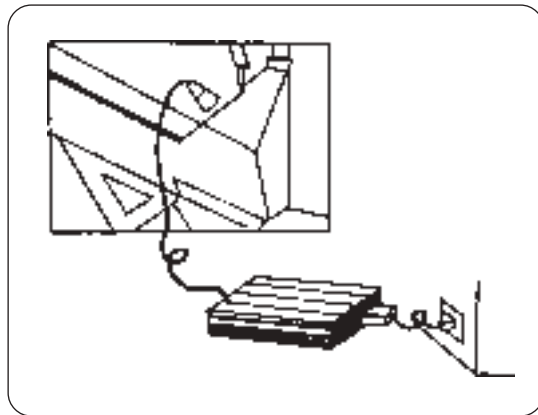

BICYCLE CARE BICYCLE CARE CHECKLIST IN SCHEDULE

Each Time You Ride	<ul style="list-style-type: none"><input type="checkbox"/> Follow safety information provided on page titled:Preparation Befor Riding.<input type="checkbox"/> Wipe off your bicycle with a damp rag.<input type="checkbox"/> heck tyre pressure.<input type="checkbox"/> Check brakes.
Weekly	<ul style="list-style-type: none"><input type="checkbox"/> Oil cable,chain and pivot points (brake levers and calipers,shift levers,derailleurs) with a light bicycle lubricant.Avoid heavy oils that evaporate and leave a gummy residue. Remove excess oil to avoid dirt buildup.<input type="checkbox"/> Tighten any loose nuts and bolts.
Monthly	<ul style="list-style-type: none"><input type="checkbox"/> Check wheels and have the bicycle shop true them if necessary.<input type="checkbox"/> Replace brake shoes if they are worn down past the grooves.<input type="checkbox"/> Clean chain,derailleurs,and other greasy parts with a brush and kerosene and then relubricate.<input type="checkbox"/> Check gear adjustments.<input type="checkbox"/> Recharge battery if unused
Every 3 Months Every Year	<ul style="list-style-type: none"><input type="checkbox"/> Clean all bearings in the hubs and steering set.Repack bearings with grease. Oil or grease pedal bearings.<input type="checkbox"/> Replace frayed cables.<input type="checkbox"/> Replace tyres if they are split or if cord can be seen anywhere.

BICYCLE CARE

Storage

Improper storage is very hard on a bicycle.

- 1) Before storing your bike, clean and lubricate it.
- 2) Hang the bicycle off the ground, with the tyres at approximately half pressure.
- 3) Do not store near electric motors (ozone destroys rubber and paint).
- 4) Before riding the bicycle again, be certain it is in good working order.
- 5) Batteries have to be charged every three months at least, also when the bicycle is not being used.

This maintenance schedule is based on normal usage. If you ride your bike more than average or in rain, snow, or off road conditions, you will want to go over your bicycle more often than the schedule suggests. If any part appears to be malfunctioning, check and adjust it immediately if you can do so yourself, or consult your dealer.

Never ride any bicycle that is not operating properly.

Security

To avoid theft, observe the following precautionary measures:

1. Keep a record of the serial number in a safe place.
2. Purchase a lock from a manufacturer that guarantees its absolute effectiveness against bolt cutters and saws.
3. Never leave your bicycle unlocked.

Routine Maintenance

Keeping your bicycle properly maintained is extremely important. Use the following maintenance notes and schedule as a guide to complete care. You can do many of these operations yourself, but

we recommend an expert to do the more technical tune-up work. If you have questions about how to care for your bike, please feel free to ask your dealer.



1)



2)

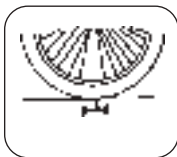

3)



4)



5)

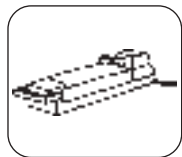

6)



7)



8)



9)



10)

- 1) Please clean up the bike routinely. (Do not use aggressive solvent or gasoline)
- 2) To replace part, please come to **aprilia** authorized dealer for replacing.
- 3) Check and keep the proper tire pressure.
- 4) Park your Aprilia in a sheltered place away from rain, heat and humidity.
- 5) Please turn the key to "Off" position and take the key out when not in use.
- 6) If your bike has been stored for a long while, clean and lubricate it, and recharge the battery before riding.
- 7) When cleaning, don't let water come into contact with any electrical components.
(IMPORTANT TAKE OUT THE BATTERY BEFORE CLEANING!!)
- 8) When replacing parts, always use the originally specified components, obtainable from your **aprilia** dealer.
- 9) Don't try to dismantle electrical components.
- 10) Do not take a seat on the bike when the kickstand is in use.

TROUBLE SHOOTING

Please refer this table for problems and remedies.

If problem remains unsolved, please call for service from **aprilia** authorized dealer.

Problem	Cause	Remedy
Hard pedaling	Key isn't in "On" position.	Turn the key to "On" position.
	Battery isn't firmly located; no good contact.	Make sure the battery is firmly located.
	Low battery	Recharge fully.
Reduced range	Road condition or overload.	Range varies according to load, terrain & road condition and outside temperature.
	Bike is not used for a long time.	Recharge battery before riding
	Battery running out of life.	Buy new battery.
Malfunction of the battery recharging	Malfunction of the re-charger.	Check & repair the re-charging tackle.
	Malfunction of the battery.	Check battery-replace it if necessary
	Switch is not in "Off" position.	Turn the key to "Off" position.
	Temperature of battery is too high.	Wait to recharge when the battery gets cooler.
	Temperature is too low.	Recharging can't be done if the temperature is below 0°C J. Change to a warmer place for recharging.
Strange smell of recharger.	Malfunction of the electric circuit	Pull out of mains socket immediately. Call for service from authorized dealer.
Temperature of recharger and battery is too high	If the temperature is very high and the recharger remains on there is the malfunction of the electrical circuit.	Pull out of mains socket immediately. Call for service from authorized dealer.
Can't remove the battery unit	Obstructed by other object.	Check and remove the object.
	Switch is not on "Open" position.	Turn the key to "Open" position.

APRILIA WARRANTY

Dear Customer,

aprilia S.p.A., based in Via Galilei 1, 30033 Noale (VE), Italy (hereinafter referred to as "**aprilia**"), congratulates you on choosing an **aprilia** product covered by a warranty (hereinafter referred to as "Warranty") according to the terms and conditions stated below.

We recommend operating, maintaining and repairing your new **aprilia** electric bicycle in strict compliance with the indications provided in the Operation and Maintenance Manual.

TERMS AND CONDITIONS

1. VALIDITY

The Warranty is valid for a period of 2 (two) years from the date of purchase.

The battery is guaranteed for one year.

2. TERRITORY

The Warranty covers all **aprilia** electric bicycles sold in the territory of the European Union.

3. INITIATION/VALIDITY

Your **aprilia** electric bicycle is accompanied by an Operation and Maintenance Manual containing a "Warranty Initiation Form", which is required to initiate the Warranty. You are kindly requested to fill in the form with your particulars and with the identification data of

the **aprilia** vehicle you have purchased, and to return it to the following address within 15 (fifteen) days from the date of purchase:

Aprilia Warranty Center
Via Rovereto 33/35
20059 Vimercate (Milano)
Italy

The Warranty Initiation Form must bear the official stamp of a dealer or subdealer expressly authorized by **aprilia**. The form must be returned with a copy of the receipt of purchase, or any other document serving as proof of purchase.

The Warranty can also be initiated by fax or via the Internet directly by **aprilia** dealers qualified for this type of service. Removing, erasing or tampering in any way with your vehicle's frame serial number makes the Warranty null and void.

4. WARRANTY CLAIM

Should you experience any malfunctioning of the product you have purchased, you are entitled to request the warranty service within the Warranty period. To put in a warranty claim, you must apply to an authorized **aprilia** dealer, subdealer or workshop within 60 (sixty) days from the time the malfunction was discovered and produce, in addition to presenting your vehicle, the Operation and Maintenance Manual or any other document serving as proof of the date of purchase. If any part of the vehicle is found to be defective because of faulty materials and/or workmanship by the **aprilia** dealer, subdealer or workshop, or by **aprilia** itself, the part involved will be repaired or replaced (at **aprilia**'s option) at no expense for the new components and/or necessary labour.

5. EXCLUSION

The Warranty does not cover ordinary maintenance, servicing, adjustments and consumables.

Also excluded from the Warranty is damage resulting from:

- Tampering, neglect, improper or imprudent use.
- Poor and inadequate maintenance.
- Rust and corrosion.
- Improperly performed repairs or incorrect replacement of parts with spares.
- Use of components not produced or supplied by **aprilia**, modifications not recommended or approved in writing by **aprilia**.
- Ordinary wear and tear of components, battery included.
- Activities such as hire, business use, competitions, tests, shows and other public performances.
- Accidents and shocks due to improper riding conduct or fortuitous events.

Finally, no coverage is provided for any inconvenience resulting from the impossibility of using the vehicle during repairs.

6. NOTE

The network of **aprilia** distributors and dealers, as well as **aprilia**'s employees and agents, are not authorized to change or extend the warranty terms and conditions.

The performance of any after-sales service under the Warranty terms does not constitute an acknowledgement of or an agreement on defective design and manufacture of **aprilia** products.

Aprilia reserves the right to discontinue the manufacture of its products and to change the specifications of products already marketed at any moment and without notice.

7. FINAL PROVISIONS

Aprilia acknowledges no other warranties, statements or promises previously made by third parties, orally or in writing. All guarantees not expressly covered in this document are therefore excluded.

The rights arising under the Warranty are in addition to and do not affect the statutory rights granted in relation to the sale of consumables.

NOTES

WARRANTY ACTIVATION FORM

This form serves to activate your warranty. You are therefore requested to complete it by inserting your personal data and send it on to the following address: **Aprilia Warranty Center** Via Rovereto 33/35 20059 Vimercate (Milan), Italy, within 15 (fifteen) days of purchasing your vehicle. The warranty can also be activated via fax or Internet directly at the **aprilia** Salesrooms which offer this service.

OWNER'S NAME _____

ADDRESS _____

TOWN _____ POST CODE _____ COUNTRY _____

TEL. N° _____ E-MAIL _____

SALESROOM/SALES PERSON* _____

SALESROOM/SALES PERSON'S CODE* _____

TOWN _____

DATE OF PURCHASE _____

FRAME N° _____

We hereby declare to have assembled the bicycle following the assembly instructions and the programme of pre-delivery operations appropriate for this model.

STAMP AND SIGNATURE OF THE SALESROOM/SALES PERSON* _____

*A sales person expressly authorised by Aprilia on activating the warranty.

The undersigned authorises **aprilia S.p.A.** to insert his data in computer or telecom archives in order to fulfil the obligations connected with this warranty to carry out research and investigations into the market, to send informative and promotional material, also using specialised companies working on behalf of **aprilia S.p.A.** for these operations. The undersigned can at any time demand and obtain changes to or the cancellation of all his data should they be dealt with in breach of the law, or oppose their use with a simple written request addressed to the owner of the data, **aprilia S.p.A.**, via G. Galilei 1 - 30033 Noale VE, for the attention of the Head of Treatment of Personal Data in accordance with what is laid out in article 13 of the law 675/96.

Cross the box if you do not wish to receive informative or promotional material

DATE _____

CLIENT'S SIGNATURE _____