

Use and Maintenance



Benelli





1	General information.....	1	4	Operation.....	26
1.1	Symbols.....	2	4.1	Using the motorcycle.....	26
1.2	Identification data.....	3	4.2	Pre-riding checks.....	27
2	Safety information.....	5	4.3	Running-in.....	29
2.1	Safety.....	5	4.4	Selecting the display functions.....	30
2.1.1	Motorcycle modification and trim personalization.....	5	4.5	Adjusting the clock.....	33
2.1.2	General safety regulations.....	6	4.6	Parking the motorcycle.....	34
2.1.3	Vehicle load.....	8	4.7	Saddle disassembly driver.....	35
2.1.4	Use of the vehicle in competitions.....	9	4.8	Saddle disassembly passenger.....	35
2.1.5	Advices for safe riding.....	9	4.9	Refuelling.....	36
2.1.6	Protective clothing.....	12	4.10	Starting the engine.....	38
2.1.7	Suggestions against theft.....	13	4.11	Improve our riding skills.....	39
2.2	Safety - Visual and acoustic signals.....	14	5	Adjustments.....	40
3	Controls and instruments.....	15	5.1	List of adjustments.....	40
3.1	Location of controls and instruments.....	15	5.2	Recapitulatory table of adjustments.....	42
3.2	Sidestand.....	16	5.3	Adjustments that can be done by user.....	43
3.3	Handlebar controls, left side.....	17	5.3.1	Front brake lever adjustment.....	43
3.4	Handlebar controls, right side.....	19	5.3.2	Adjusting the rearview mirrors.....	43
3.5	Ignition switch and steering lock.....	21	5.3.3	Front projector regulation.....	44
3.6	Gear lever.....	23	5.3.4	Front projector lamps replacement.....	45
3.7	Instruments and warning lights.....	24	5.4	Adjustments that has to be done by a Benelli Authorized Workshop.....	46
3.7.1	Multifunction display.....	25	5.4.1	Clutch lever play.....	46
			5.5	Adjusting the rear suspension.....	47



5.5.1	Adjusting rear suspension spring preload.....	49	6.12	Battery.....	79
5.5.2	Adjusting rear suspension rebound damper hydraulic device.....	49	6.13	Cleaning the motorcycle.....	80
6	Maintenance.....	51	6.14	Prolonged inactivity.....	82
6.1	Tables of scheduled maintenance and checks.....	51	7	Technical information.....	83
6.2	Tools and accessories supplied.....	60	7.1	Specifications.....	83
6.3	Table of lubricants and fluids.....	61	8	Variants Sport and Titanium.....	89
6.4	Checking the engine oil level.....	62	8.1	Adjusting the front suspension.....	90
6.4.1	Topping up the engine oil level.....	63	8.1.1	Adjusting front suspension spring preload.....	91
6.5	Checking the coolant level.....	65	8.1.2	Adjusting front suspension rebound damper hydraulic device.....	91
6.5.1	Topping up the coolant level.....	66	8.1.3	Adjusting front suspension compression damper hydraulic device.....	92
6.6	Checking the wear of the brake pads.....	68	8.2	Adjusting the rear suspension.....	93
6.7	Checking the brake fluid level.....	69	8.2.1	Adjusting rear suspension spring preload.....	95
6.8	Checking the tires and rims.....	71	8.2.2	Adjusting rear suspension rebound damper hydraulic device.....	95
6.8.1	Checking of the rims and the wheel rims.....	73	8.2.3	Adjusting rear suspension compression damper hydraulic device.....	96
6.9	Cleaning checking and lubricating the drive chain.....	74	8.2.4	Hydraulic compression braking system at high-speed back - wheel suspension.....	96
6.9.1	Cleaning.....	75	9.1	Power Control System.....	98
6.9.2	Lubrication.....	75	9.2	Power Control System Activation.....	99
6.10	Checking the idle speed.....	76			
6.11	Replacing the fuses.....	77			





1 General information

Dear Customer,

We invite you to read this Owner's Manual before using your new TNT.

It contains important information for a safe use of the vehicle and to keep it in perfect working order. Keep it by putting it in the special papers-case compartment.

We remain you, however, that TNT is a high performance vehicle that needs to be ride with attention and skill.

You better refrain from driving the vehicle out of bounds, if you are not sure of your ability in managing it; however, when you ride on public street or open to the public, you have to scrupulously observe the Highway Code.

Always remember to use a homologated helmet, of your size, and always correctly laced up. We recommend you, besides, always to wear an appropriate protective wear.



1.1 Symbols

In order to make more simple and readably the most important information, we have used the following symbols:



Danger – Warns you that there is a serious intrinsic danger that could cause personal injuries and deadly accidents in case you don't follow the supplied directions.



Warning – Warns you that there is a danger that could cause personal injuries and deadly accidents in case you don't follow the supplied directions.



Caution – Reminds you a safety practice you better follow or an unsafety activity you better avoid if you don't want to risk undergo personal injuries or to damage your vehicle.

Benelli SpA reserves the right to make any changes, whenever deemed, to its products and to this manual. Wherever you will find any dissimilarity between what is written on this Owner's Manual and the specific fitting-out of your vehicle, don't hesitate to download from the web site www.benelli.com the update version of the Owner's Manual, or contact the Customer Service Benelli calling 800342300, which will arrange to send to you the new update version.





1.2 Identification data

- 1. vehicle identification number
- 2. engine serial number
- 3. homologation data

We recommend writing down the main numbers in the spaces provided below.

FRAME No. ZBN _____
ENGINE No. _____
COLOR CODE _____
KEY No. _____



Identification motorcycle

The motorcycle is identified by the matriculation frame number.

Motorcycle key identification

The key, supplied in four copies, can be used both for starting the motorcycle and for operating all the locks. Keep the key copies in a safe place. Knowing the key identification number is essential in case you need to ask for a duplicate of the key.

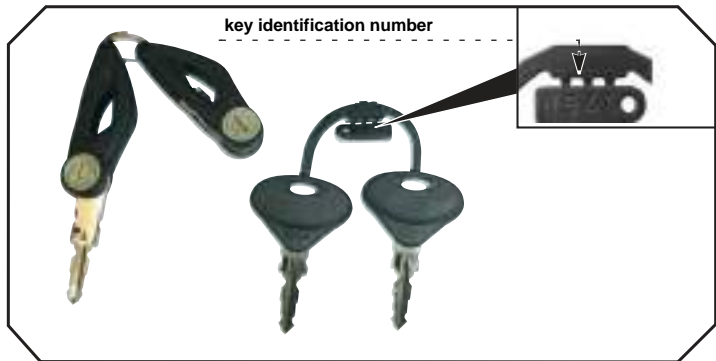

Identification of motorcycle colour combination

The colour code must be mentioned when ordering body spares. This code can be read on the labels placed under the saddle.

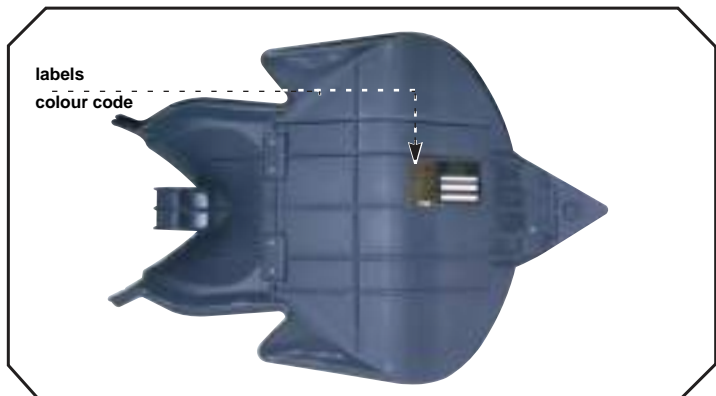

Spare parts order

If you need to order spare parts, beside the matriculation frame number, it can be necessary to mention the engine number, the colour code and the key identification number.





2 Safety information

2.1 Safety

2.1.1 Motorcycle modification and trim personalization



WARNING It is strictly forbidden to intervene on the vehicle by modifying the mechanical components or by replacing them with non genuine spare parts. All this activities make the vehicle homologation forfeit rendering it unusable for public street use, and can also cause serious damages for the user and for the vehicle itself. Benelli is not responsible for any damage to persons or things caused by any modifications of the motorcycle original conditions.



It is possible to personalize the suspension trim by working on the special adjustments this activity is absolutely unwary unless the user is absolutely confident in his technical ability. The trim adjustment can compromise the motorcycle safe use and, therefore, it has to be done only by expert persons. Wherever you want to personalize the motorcycle trim in relation to your personal requirements, we suggest you to apply to a Benelli Authorized Workshop. You can find the Benelli Authorized Workshop list on Benelli web site www.benelli.com or calling the Benelli Customer Service dialling 800342300.



2.1.2 General safety regulations

Before you start riding make sure you keep in mind the controls, characteristics, working and limits of the motorcycle.

In order to guarantee the vehicul maximum efficiency and reliability it is essential that your Benelli Authorized workshop does all the maintenance operations written on the “Maintenance” section of this Owner’s Manual, following carefully all the directions and suggestions.

We advise you against having the maintenance operations and the repairs done by persons or workshop that don’t belong to the Benelli Authorized Workshop net. Especially we advise you against doing on your own the maintenance operations and the repairs on your *TNT!*

For any necessity or further information don’t hesitate to apply to your Benelli Distributor or to the nearest Benelli Authorized Workshop. You can find the Benelli Distributor and the Benelli Authorized Workshop list on the web site www.benelli.com or calling the Benelli Customer Service dialling 800342300.

The full control of this motorcycle is basic for a safe riding. Therefore it is necessary to start riding with a good concentration and in perfect physical conditions, apare from always assessing the street and atmospheric conditions.

In order to avoid compromising handling and stability of your motorcycle, you should obey the following warnings:

- do not attach any object to the vehicle;
- do not hook a sidecar, a tow or any other accessory to the motorcycle;
- do not remove any part and/or component;
- do not modify the vehicle in any way;
- do not wear garments that could adversely affect control and handling of the motorcycle.





Do not ride this motorcycle if you do not possess a regular driving licence. Failure to heed this warning constitutes a breach of the Highway Code, besides posing a serious hazard to the driver's and other people's safety. Always wear a helmet, even on short rides.

Always wear suitable clothes, especially when travelling by night (e.g. garments with fluorescent bands).

When refuelling, switch off the engine and refrain from smoking.

Do not start the engine in closed places. Exhaust gases are toxic and can quickly saturate the air and cause fainting or even death.

While riding, always keep both hands on the handlebars.

Park the vehicle where it is unlikely to be bumped into or damaged. Even slight or involuntary bumps can cause the vehicle to topple over, with subsequent risk of serious harm to people or children.

To prevent the vehicle from tipping over, never park it on soft or uneven ground, nor on asphalt strongly heated by the sun.

Do not cover your motorcycle with a canvas soon afterwards riding. Before covering your motorcycle, wait until the engine and the exhaust pipes have thoroughly cooled.

If your motorcycle has been involved in an accident, check all levers, wires, hoses, brake calipers and other main parts for damage. Do not use the vehicle if you detect a damage that could adversely affect safety.

As soon as possible and, however, before using your motorcycle after an accident, even if there are not any visible damages, it is necessary to have it inspected by a Benelli Authorized Workshop, in order to verify the absence of defects and/or damages that the owner could not be able to detect.



2.1.3 Vehicle load

The vehicle is designed for use by the rider with a passenger. To drive safely and under the highway code, never exceed the maximum allowed total gross weight of 400 kg (881.84 Lbs).

That is the sum of the motorcycle, driver, passenger and load weight, according to the EEC 92/61 directive.

WARNING



Since the load can strongly affect handling, braking, performance and safety characteristics of your motorcycle, you should always keep in mind the following warnings.

NEVER OVERLOAD YOUR MOTORCYCLE! Driving an overloaded motorcycle can cause damage to the tyres, loss of control of the vehicle and serious injury. Check that the total of driver and passenger weight, the burden weight and the vehicle gross weight never exceed the granted values.

Never carry any incorrectly fastened object on your motorcycle, because it could move from its position during riding.

Steadily fasten the heaviest objects near the center of the motorcycle, and equally divide the load on both sides of the vehicle.

Do not insert any object in the spaces on the frame trellis, in order to avoid interfering with the movable parts of the motorcycle.

Before riding, always check the wear and the pressure of the tyres.

Adjust the suspensions according to the load.

Even if the motorcycle is correctly loaded, drive with caution and never exceed 130 km/h (80.6 mph) when you carry a load.





2.1.4 Use of the vehicle in competitions

Your *TNT* was projected for road use.

However, making some modifications, considering the high performances that the motorcycle can reach, it is possible to use it also in competitions.

However, you need to remember that once you transform the motorcycle for competitions use, it is no more suitable for street traffic unless it is brought to its original conditions.

To meet the passionate drivers numerous requests, **Benelli** has designed a number of special components for use in competitions and/or sporting events. The use of such components is strictly limited to areas closed to traffic.

Failure to observe this restriction constitutes a breach of the Highway Code for which **Benelli** cannot be held responsible. For more information about **Benelli** special components visit the web site www.benelli.com or call the Benelli Customer Service dialling 800342300.



WARNING

Riding the vehicle in competitions requires considerable skill and experience as well as an accurate setup of the motorcycle which was to be made only by particularly prepared persons.

2.1.5 Advices for safe riding

Besides being a means of transport, your motorcycle is a source of recreation and excitement. (and this is true, especially, when we talk about a *TNT!*).



However the nature itself of the vehicle involves, a certain amount of risk. To ensure maximum safety, in addition to scrupulously observing the warnings and instructions provided in the previous paragraphs, it is essential to take a few additional precautions.

In particular:

Before starting off

Follow all the directions given in the section “PRE-RIDING CHECKS”. Conduct an overall check of all safety-related aspects of the motorcycle.

Familiarizing with the vehicle

The rider’s ability and his mechanical skills form the basis of riding safety. It is advisable to practise riding in areas without traffic until you have become familiar with the vehicle and its controls.

Being aware of one’s limits

When riding, never exceed your limits nor those imposed by law. Being aware of your limits and acting accordingly will help you avoid accidents.

Adverse weather conditions

Be very careful when riding in adverse weather conditions. On wet roads, for example, the braking distance increases as a result of reduced tyre traction. It is therefore necessary to travel at moderate speed and avoid abrupt braking and acceleration. Pay particular attention when riding on slippery surfaces such as road markings, manholes, level crossings, bridges, gratings, etc. Considering that a motorcycle cannot provide the same degree of shock protection as a motor vehicle, it is essential to adopt a “defensive” riding attitude, particularly in the adverse weather conditions described above.





When riding down long hills, reduce the speed of your motorcycle by closing the throttle and using a low gear ratio to take advantage of engine braking. Use the front and rear brakes as little as possible to maintain your speed, in order to prevent brake overheating and fade.

Special attention should be given to the braking system, which plays a key role in ensuring safety. When braking, always take account of the speed of the vehicle and the condition of the road surface.

The braking action should always be applied gently and gradually to both wheels.

Performing this operation and, more in general, riding the vehicle always requires the utmost care. Therefore, caution should be exercised by all users, and in particular by inexperienced riders.

When you make a turn, avoid sudden braking. Failure to observe this warning could lead to the sliding of the wheels and the loss of control of the vehicle. Always operate the brakes before starting a turn.

When you are laterally blown by a sudden gust of wind (as it may happen when you're overtaken by a vehicle of great dimensions, when you come out of a tunnel or when you're driving in a hilly zone), you could lose control of the vehicle. While driving under the above mentioned conditions, reduce your speed and be careful to avoid sideways gusts of wind.

Maintain a safe distance behind vehicles in front of you and adjust your speed to the weather and traffic conditions. Remember that, as your bike picks up speed, stopping distances increase and the motorcycle becomes more difficult to control. In any case, never exceed the speed limits imposed by the Highway Code.

It is strictly forbidden to drink alcoholic beverages or take drugs before riding. Even very small amounts of these substances adversely affect the rider's ability to control the vehicle.



HELMET

Wearing the helmet when you ride a motorcycle in many countries, including Italy, is compulsory. However, wherever this obligation doesn't exist, it is absolutely advisable to wear a helmet, taking care of choosing a homologated and of the right size one. If the helmet has no visor take care of wearing appropriate protective glasses during your riding.

The helmet has to be always laced up. If you carry a passenger you better make sure that he wears correctly a homologated helmet. Never wear light helmet DGM (they can be used in Italy only for riding mopeds).

2.1.6 Protective clothing

Always wear suitable protective clothing.

In particular, the following items should be worn:

- A close fitting jacket, made of tough material and easy to fasten.
- Supple, reinforced gloves providing both sensitivity and protection.
- Strong, close-fitting trousers covering the legs completely.
- Soft, reinforced boots providing both sensitivity and protection.

In any case, the clothes must allow complete freedom of movement and not hamper the rider in any way.

In addition, they must have no loose parts capable of catching in the control levers, the footrests, the wheels, the drive chain, etc., in order to avoid dangerous situations.





WARNING

Protective clothes do not afford complete protection against the risk of personal injury in the event of an accident. It is therefore essential not be deceived by the false sense of security that you might perceive by wearing protective clothing. When riding, always adopt a cautious attitude and follow the recommendations given in the previous paragraphs.

2.1.7 Suggestions against theft

Your TNT is a precious property and, like that, it has to be protected.

- Every time you park your motorcycle, operate the steering lock and remove the ignition key.
- Park your motorcycle in a closed garage every time it is possible.
- Install a good quality anti-theft device on your vehicle.



2.2 Safety - Visual and acoustic signals

Before each ride, it is essential to verify the operation of the visual and acoustic signals.

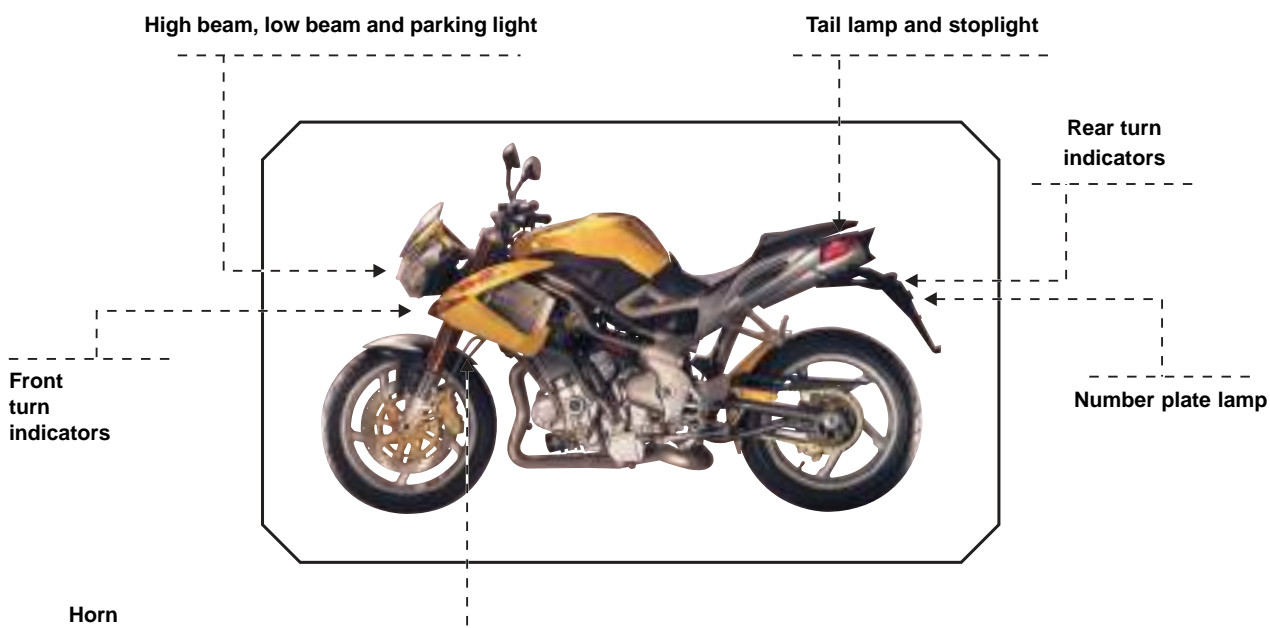

3 Controls and instruments

3.1 Location of controls and instruments

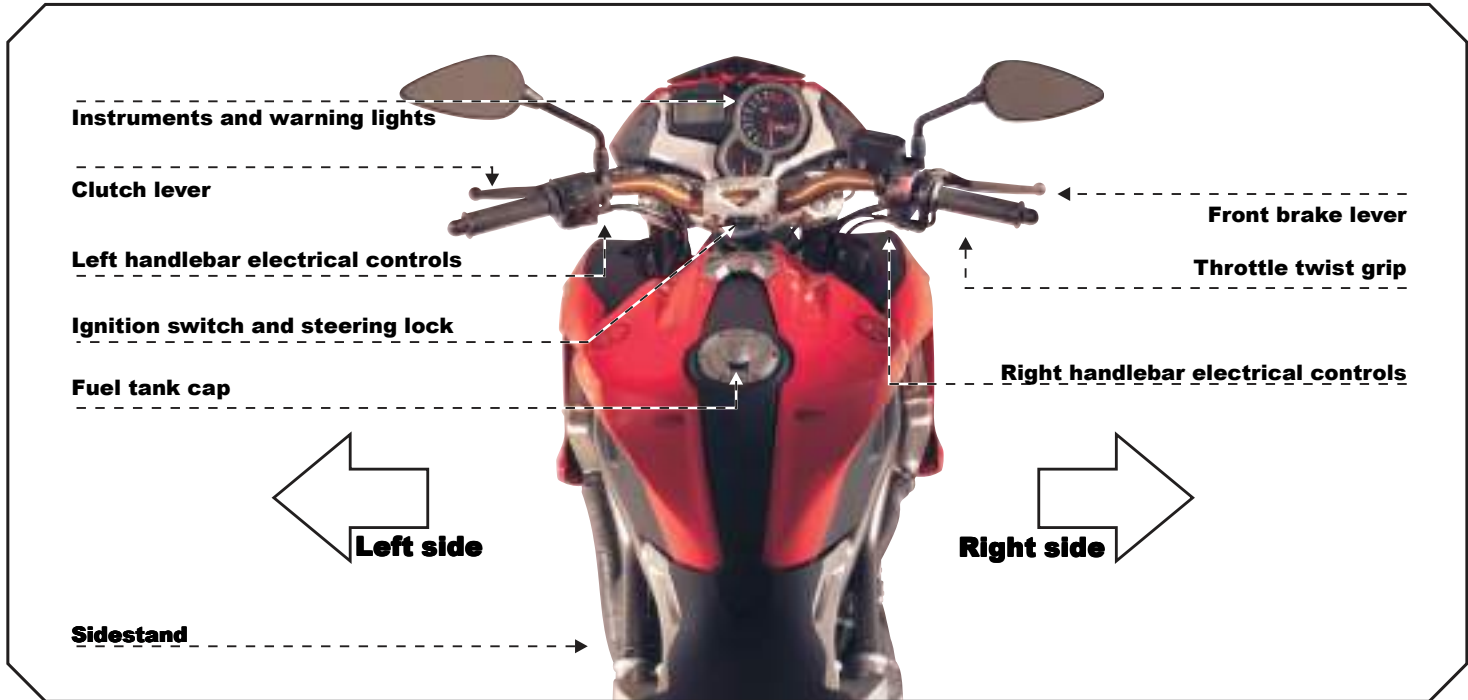

3.2 Sidestand

The sidestand is equipped with a safety switch that prevents the motorcycle from moving off while the stand is down.

In case of working engine, with gear engaged and clutch lever pulled, the switch automatically turns off the engine by cutting the current supply.

If the motorcycle is parked (sidestand down) and the gears are engaged, the switch prevents the engine from being started, thereby avoiding the risk of accidentally toppling the vehicle.



Check in any way the sidestand position before riding.





3.3 Handlebar controls, left side

High beam flasher button
Press the button repeatedly.

Control Lights
☀ Lights on
☀☀ Low or high beam on

Control Turn indicator
Shifting the lever to the left or right switches on the left or right turn indicators. The switch then returns to the central position. Press to turn off the indicators.

Horn button
Press to operate the warning horn.

Clutch lever
Move towards/away from the handgrip to release/engage the clutch.



Clutch lever

It is used to engage/disengage the clutch.

Control Lights

Pushing the switch you can turn the sidelights into the headlights or dipped headlights.

Low/high beam button

When the light switch is in the position, the low beam is on. The high beam can be switched on by pressing the button when allowed by the traffic and road conditions.

Control Turn indicator

It is used to show the rider's intention to change direction or lane.



WARNING: Failure to switch the turn indicators on or off at the right time may cause an accident. Always switch on the indicators before turning or changing lanes. Then be sure to switch off the indicators after completing the operation.

Horn button

It is used to attract the attention of other road users in case of danger.

High beam flasher button

It is used to attract the attention of other road users in case of danger. When the high beam is on, the function is inactive.

Start button

It is used to visualize all the functions of the LCD display.



3.4 Handlebar controls, right side

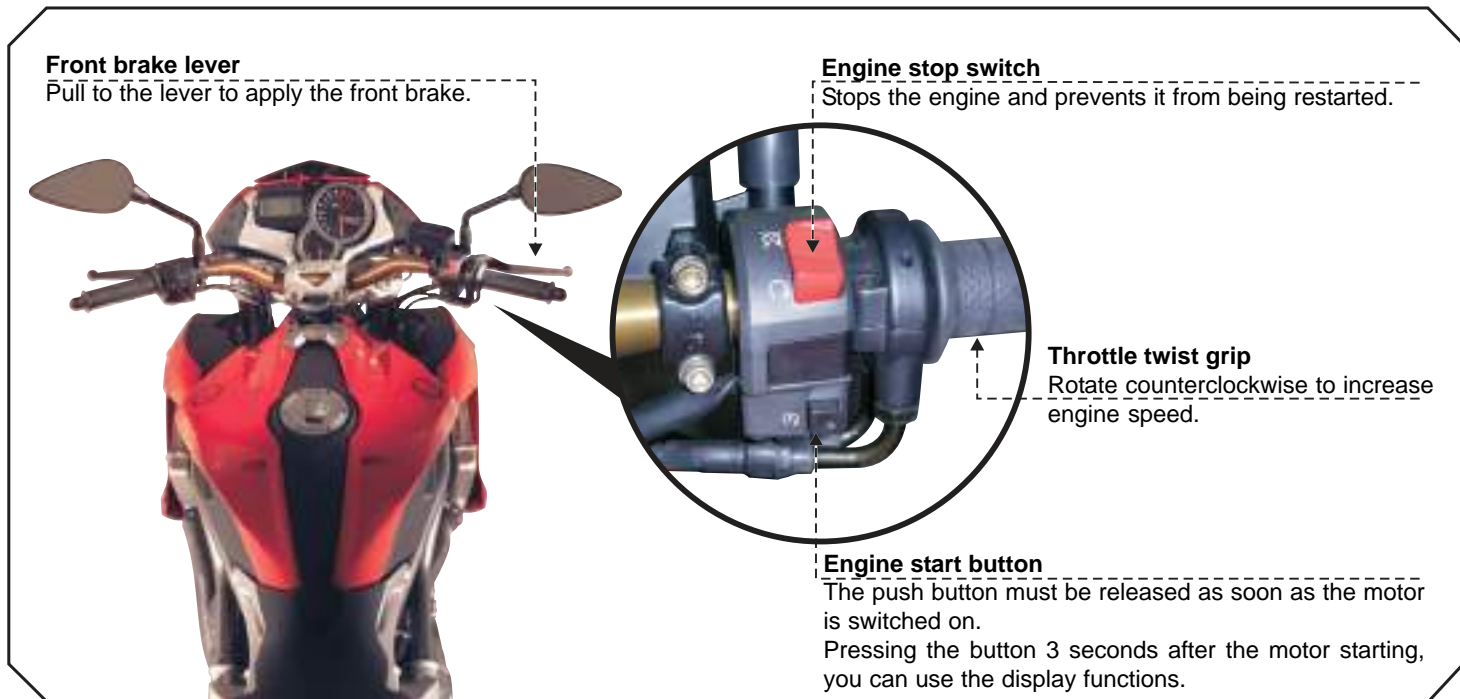

Engine stop switch

It is used to switch off the engine in an emergency. The ignition circuit is disabled, preventing the engine from being restarted. To be able to restart the engine, return the switch to the "ON" position.



Under normal conditions, do not use this switch to shut off the engine.

Front brake lever

It controls a hydraulic circuit that operates the front wheel braking system.

Throttle twist grip

It controls the fuel-air mixture supplied to the engine, which regulates engine speed. To increase engine speed, rotate the hand grip from its idle position counterclockwise.

Engine start button

This device permits the motor starting, pushing the steering clutch, if it is used 3 seconds after the motor starting, you can use the display functions.



To avoid damaging the electrical equipment, be sure not to hold down the button for longer than 5 consecutive seconds.

If, after some attempts, the engine does not start, contact your authorized Benelli service center.

3.5 Ignition switch and steering lock



WARNING

Do not attach a ring or any other object to the ignition key as they may hinder the steering action. Never attempt to change the switch functions while riding, as you may lose control of the vehicle. Always check the absence of any restriction in the steering action before you ride.



The ignition switch enables and disables the electrical circuit and the steering lock. The four positions of the switch are described below.

OFF position

All electrical circuits are deactivated. The key can be removed.

ON position

All electrical circuits are activated. The instruments and warning lights perform the self-diagnostic cycle. The engine can be started. The key cannot be removed.

LOCK position

Turn the handlebar to the left. Press the key in gently while rotating it to the LOCK position.

All electrical circuits are deactivated and the steering is locked. The key can be removed.

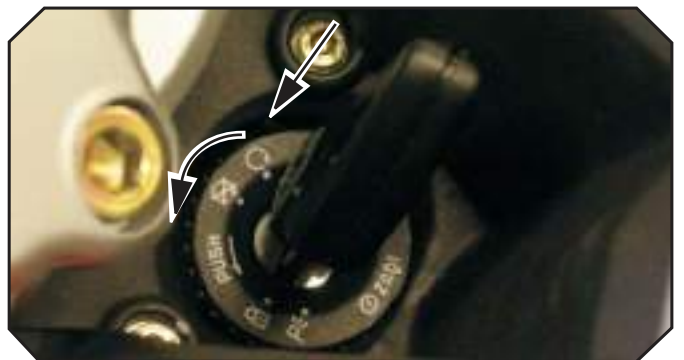

“P” Position



CAUTION

Do not leave the key on the P position for a long time, in order to avoid discharging the battery of your motorcycle.

Turn the key from the LOCK position to the P position (parking).

All electrical circuits are deactivated except the parking lights (position lights). The steering is locked.

The key can be removed.





3.6 Gear lever



WARNING
Only operate the change gear with the clutch lever fully pulled.

The **N** (neutral) position is indicated by the warning light on the instrument panel.
 To change into first gear, push the lever down.
 To change into second gear, lift the lever up. Lifting the lever up repeatedly engages all the other gears in succession up to the sixth speed.



3.7 Instruments and warning lights

The instruments and warning lights are activated by turning the ignition switch to the ON position. After a preliminary check the displayed information reflects the current general condition of the motorcycle.

High beam warning light (blue)

Lights up when the high beam is activated.

Warning lights

Turn indicator light (green)

Lights up when the turn indicators are activated.

Reserve fuel indicator (amber)

Comes on when approximately 5 litres of fuel are left; in this case, fill up the tank as soon as possible.

Multifunction display

Water temperature indicator

Indicates the cooling water temperature expressed in Celsius degrees (°C).

Tachometer

Indicates the engine rpm expressed in thousands.

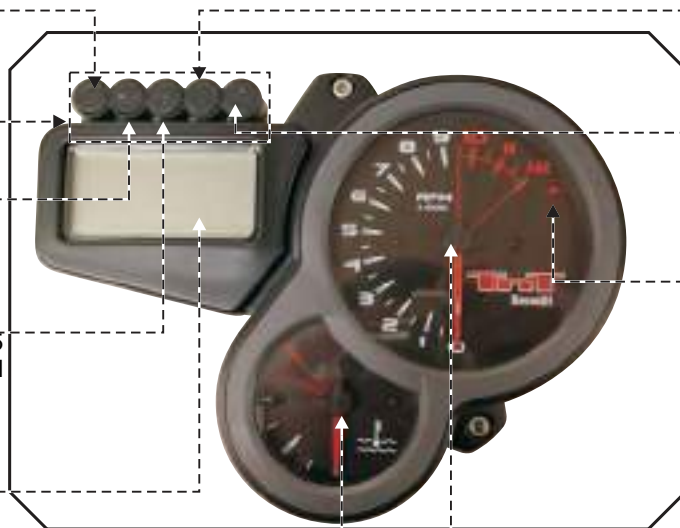

Neutral indicator (green)

Lights up when the gears are in neutral.

Injection warning light (orange)

Lights up in case of the injectors failure; in this case, contact an authorized service center as soon as possible.

Alarm led

Lights up when the oil pressure or the cooling water temperature not correct (more than one anomalies may occur simultaneously); at the same time, the writings "OIL", "H₂O", "BAT" start flashing on the tachometer in place of the speed indication. If the alarm led lights up, immediately stop the vehicle, allows it cool down for a few minutes, check the oil level rature or the battery voltage and top up if necessary. If the problem persists, contact an authorized service center as soon as possible.





3.7.1 Multifunction display

Speedometer

Measures the speed of the vehicle. The speed can be displayed in kilometres per hour (km/h) or miles per hour (mph). The full-scale value is 320 km/h (199 mph).

Fuel level

Displays the amount of fuel in the tank using an 8-bar chart.

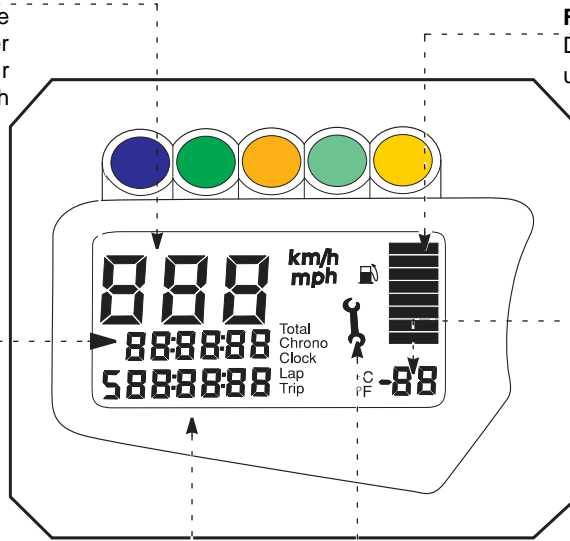

“Total” mileage counter

Displays the total distance covered from 0 to 999999 (km or mi).

“Chrono” chronometer

Displays the distance covered time expressed in minutes, seconds and hundredths.

“Clock” Displays the time (0÷12) and the minutes.

“Trip” mileage counter

Displays the partial distance covered, from 0 to 99999.9 (km or mi).

“Lap” trip

With the chrono mode it displays the intermediate time; once the chronometer is stopped, it displays the total time.

Thermometer

Displays the ambient temperature in centigrade degrees (°C) or Fahrenheit (°F).

The range is between -30 and +50 (°C) or -22 and +122 (°F).

NOTE: when a °F value greater than 99°F is displayed, the hundreds are not indicated although they are understood.

Service Warning Light

It comes on the first time after 1000 km (600 mi), and then every 5000 km (3100 mi). Whenever it lights up, contact an authorized service center as soon as possible and carefully follow the indications provided in the maintenance and control tables in this manual. When the warning light goes on, also the writing “Service” starts flashing for 10 seconds every time the vehicle is started, in place of the trip odometer “Trip” writing.



4 Operation

4.1 Using the motorcycle

This section provides the basic information needed to correctly operate the motorcycle:

- Preriding checks
- Running-in
- Selecting the display functions
- Adjusting the clock
- Parking the motorcycle
- Saddle disassembly
- Refuelling
- Starting the engine
- Improve our riding skills



PROTECT THE ENVIRONMENT

Benelli, in order to protect the interests of the community, awakens the Customers and the Technical Assistance operators to use the vehicle and dispose of its replaced parts respecting the laws in force concerning environmental pollution and waste disposal and recycling.





4.2 Preriding checks



A motorcycle can be in good running order and then become unexpectedly unreliable even if unused (e.g. deflation of the tyres, battery discharge, and so on...). It is therefore important to carry out the checks described in the table below before each ride. A few moments taken to carry out these checks will help you maintain your motorcycle safe and in perfect working order. If any of the above-mentioned parts shows a failure during its operation, have it controlled and repaired by a Benelli Authorized workshop before using the motorcycle.

Brakes	Check fluid level. Check for fluid leakage. Pull lever and press pedal to check brake operation.
Gear lever	Press pedal to check gear operation.
Clutch lever	Pull lever and check that it moves smoothly and gradually.
Engine start button/ stop switch	Check operation.
Throttle twist grip	Check that grip rotates smoothly and returns to closed position when released.



Steering system	Verify that the operation is smooth and uniform. Check for play and loosening.
Lights, visual and acoustic signals	Check operation.
Tyres	Check inflating pressure and wear.
Suspensions	Verify that the operation is smooth and uniform.
Frame fasteners	Check clearance or slackening.
Drive chain	Check clearance absence and lubrication presence.
Fuel	Check level. Refuel, if necessary. Check for fuel leakage.
Coolant	Check level. Check for leakage.
Engine oil	Check level. Check for leakage.





4.3 Running-in



Failure to observe the indications provided below can reduce performance and shorten the life of the motorcycle.

Running-in is generally considered to apply only to the engine. In fact, it should be regarded as an essential phase for other important parts such as the tyres, the brakes and the drive chain. During the very first miles, adopt a relaxed riding style.

km	rpm max.	!	NOTE
0 to 500 Km (0 to 312.5 mi)	5000 rpm		<p>New tyres must undergo a proper running-in period to reach their complete efficiency. Avoid abrupt acceleration, turning and braking during the first 100 km (62,5 mi). Failure to observe these prescriptions can lead to the sliding of the wheels and the loss of control of the vehicle with subsequent risk of accidents</p>
500 to 1000 Km (312.5 to 625 mi)	7500 rpm		
1000 to 2500 Km (625 to 1562.5 mi)	9000 rpm		

In particular, observe for the first 2500 km (1600 mi) the max revolutions number indicated in the table. After the running-in period, above 2500 km (1600 mi), the engine is "hot" and can be run to its maximum speed.



4.4 Selecting the display functions



ATTENTION
The display modification or regulation operations, must be made 3 seconds after the motor starting.

The display is provided with 3 main functions:

- 1) "TOTAL"/"TRIP"
- 2) "CHRONO"/"LAP"
- 3) "CLOCK"/"TRIP"

To move from the visualisation 1 "Total"/"Trip" to the visualisation 2 press the "Start" button for more than 2 seconds.

To move from the visualisation 2 "Chrono"/"Lap" to the visualisation 3 press the "Start" button for more than two seconds (when the chronometer is switched off).

To switch from function 3 to function 1, keep pressed the "Start" button for less than two seconds.

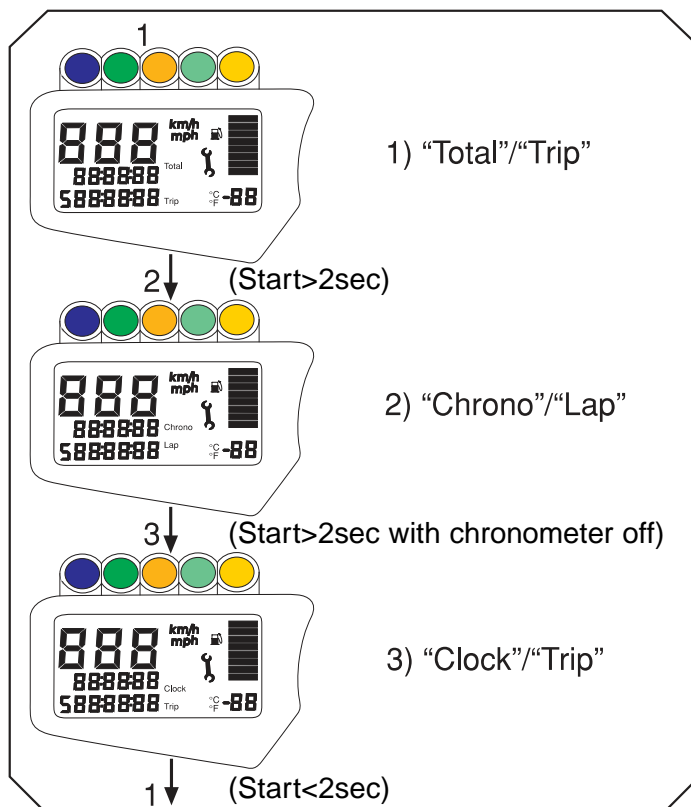



Resetting the trip mileage counters

The value of the “Trip” function can be reset pressing two times the **START** button.

NOTE:
The instrument panel has an integrated memory which retains all the parameters even when the engine is not running. Except for the clock, which is reset, all the parameters are retained even when the battery is disconnected.

Set “Chrono” / “Lap”

Move to the visualisation 2

To set the “Chrono” press the **START** button for less than one second.

To see the “Lap” from the “Chrono” position, press the **START** button for less than one second. Each time the **START** button will be pressed for less than one second, the “Lap” function will indicate the “Chrono” time, in the specific moment.

To stop the “Chrono” press the **START** button for less than one second.

To stop the “Chrono” press the **START** button for 3 seconds at least.

To leave the “Chrono” position, press the **START** button for 3 seconds at least, moving to the 3 “Clock” / “Trip” visualisation.



Set “Clock” / “Trip”

Move to the visualisation 3.

To set the timer, push the **START** button for two seconds at least. The first number starts flashing.

Press continuously the **START** button for the number regulation until reaching the number you desire.

Repeat the same operation to set the second timer number, the first and the second minutes number. Press the **START** button for three seconds at least, to stop the selection and the flashing. To reset the “Trip” from the visualisation 3 press two times the start **START** button.

Set “Km” / “Mi”

From the 1 “Total” / “Trip” visualisation, when the motor is switched on, press the **START** button for at least ten seconds.

The Km or Mi symbol will start flashing, press the **START** button to move to Km or Mi, press for at least two seconds the **START** button, to select the measure unit you desire, moving automatically to the °C o °F selection, press the **START** button for less than one second to select the temperature unit you desire.

Press the **START** button for at least three seconds, to confirm and exit from the **Set “Km” / “Mi”** visualisation.





Set "Service"

When the first 1000 Km (600Mi) will be reached and every 5000Km (3100Mi) you will see the flashing **Service** pilot light on the display, instead of the partial "**Trip**" for 10 seconds during the vehicle starting. To reset the **Service** pilot light, press the **START** button for at least ten seconds until the pilot light is switched off.

4.5 Adjusting the clock

Switch to function 3

Press the "Start" button (> 2 sec.); the first figure will start flashing.

Repeatedly press the "Start" button until the desired figure has been entered.

Press the "Start" button (> 2 sec.) to enter the following figure.

Repeat the above procedure to enter the second figure of the "hours", the first and second figure of the "minutes".

Press the "Start" button (> 2 sec.) to confirm the time adjustment and to stop the selection (the flashing).



4.6 Parking the motorcycle

TNT is equipped with the sidestand. It is possible to separately buy the central back stand.

Using the sidestand



Park the motorcycle safely on solid ground.

On slopes, engage the first gear and park the vehicle so that the front wheel faces uphill. Remember to put the gear lever in the neutral position before restarting the engine.

Using your foot, lower the sidestand as far as it will go, and then slowly tip the motorcycle toward you to bring the stand supporting foot into contact with the ground's surface.



WARNING

Do not sit on the vehicle when it is parked on the sidestand, as your full weight would rest on the vehicle's only support.





4.7 Saddle disassembly driver

Insert the key.

Press the end part of the saddle and, at the same time, turn the key counterclockwise.

Slightly lift the saddle from the rear, slide it backwards and remove it.

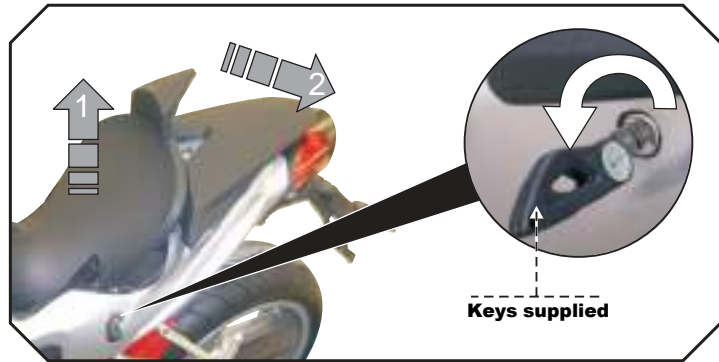

4.8 Saddle disassembly passenger

Insert the key.

Remove the pilot saddle.

Slightly lift the saddle from the rear, slide it backwards and remove it.

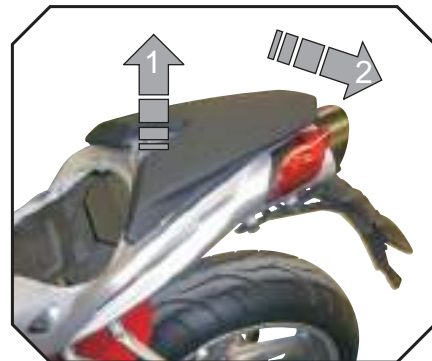

4.9 Refuelling

Lift the dust cover.

Insert the key into the lock, rotate it clockwise and lift the tank cap.

After refuelling, press down the tank cap while rotating the key clockwise to facilitate the locking. Then release the key and remove it.

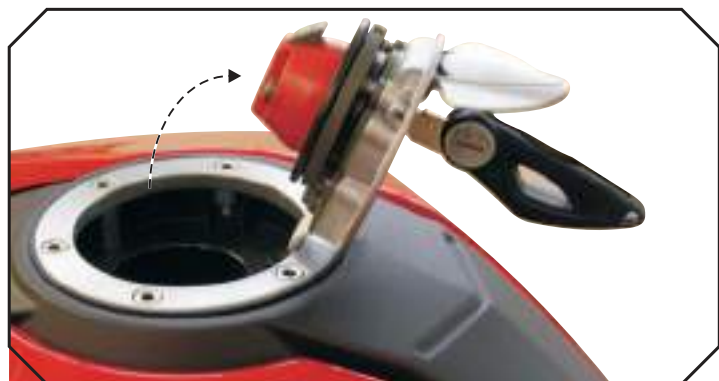



WARNING

Petrol and its fumes are highly toxic and flammable. Avoid contact and inhalation. When refuelling, switch off the engine, avoid smoking, and keep away from flames, sparks and heat sources. Perform refuelling in the open air or in a well ventilated area.

Overfilling the tank may cause the fuel to overflow as a result of the expansion due to the heat from the engine or to exposure to sunlight. Fuel spills can catch fire. The level of the fuel in the tank must never be higher than the base of the filler.

Verify that the tank filler cap is correctly closed before using the motorcycle.



Only use unleaded fuel with a R.O.N. octane rating of 95 or higher. Immediately wipe the overflow fuel with a clean cloth, to avoid damage to the painted or plastic surfaces.



4.10 Starting the engine

As you turn the ignition switch to the ON position, the instruments and the warning lights will go through the self-diagnostic cycle; during this phase, make sure that all the warning lights on the dashboard come on. One of the following conditions must be verified, in order that the ignition switch system allows engine starting:

The gears are in neutral.

The gears are engaged, the clutch lever is pulled and the side stand is up.

Press the start button without turning the throttle twist grip.

As soon as the engine starts, release the button.

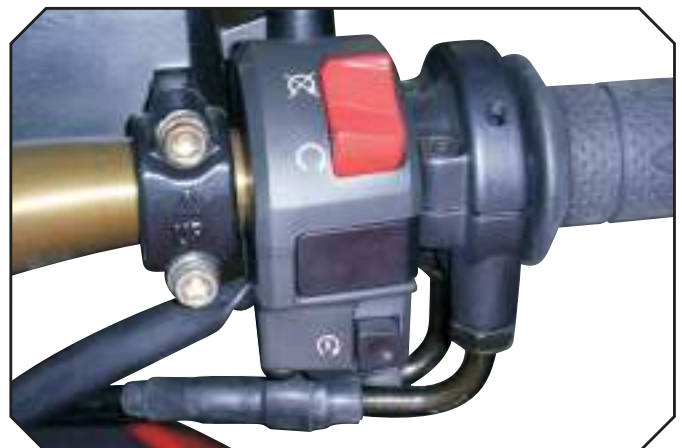

• Do not press the start button for longer than 5 consecutive seconds.

• Avoid warming up the engine while the vehicle is stationary. It is advisable to bring the engine to the working temperature by riding at reduced speed.

• To ensure the maximum life of the engine, never speed up at full throttle when the engine is cold.





4.11 Improve our riding skills

Riding a motorcycle requires experience and concentration.

Inexperienced riders should undergo a period of training and attend an introductory course consisting of theoretical lessons as well as practical riding sessions in areas closed to traffic.

The instructor's advice will help the novice rider become familiar with the basics of riding safety.

Relying on the advice of persons other than a qualified riding instructor, even if possessing specific knowledge, may prove to be useless or even dangerous, especially if the practical training takes place in an area open to traffic.



5 Adjustments

5.1 List of adjustments

There are many adjustments that can significantly improve the ergonomics, geometry and safety of the motorcycle.



WARNING

To avoid losing control of the vehicle while riding, be sure to always keep both hands on the handlebars. All adjustments must be performed when the vehicle is stationary and, where not otherwise provided in this manual, they have to be done only by Benelli Authorized Workshop; in fact, some of these operations can cause a danger for the user's safety if they are not properly done or if they are inappropriate.





Rearview mirrors adjustment

Front brake lever adjustment

Gear lever adjustment

Headlight adjustment

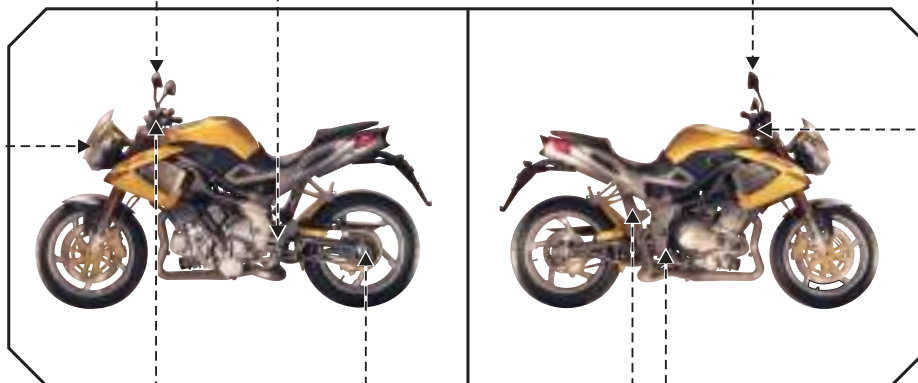

Front suspension adjustment

Back foot brake pedal regulation

Clutch lever adjustment

Drive chain adjustment

Rear suspension adjustment



5.2 Recapitulatory table of adjustments

TYPE OF ADJUSTMENT	COMPETENCE
Front brake lever adjustment	User
Clutch lever adjustment	User
Rearview mirrors adjustment	User
Front projector regulation	User
Back foot brake pedal regulation	Authorized Dealer

Adjusting rear suspension spring preload	Authorized Dealer
Adjusting rear suspension compression damper hydraulic device	Authorized Dealer
Drive chain adjustment	Authorized Dealer
Gear lever adjustment	Authorized Dealer



5.3 Adjustments that can be done by user



WARNING
Never perform the adjustment while riding.

5.3.1 Front brake lever adjustment

Push the lever forward to neutralize the spring thrust and, at the same time, adjust its position in one of the four possible directions by turning the ring nut clockwise or anticlockwise.

5.3.2 Adjusting the rearview mirrors

Move the wing mirror to regulate the position.



5.3.3 Front projector regulation

For the front projector regulation use the 2 right and left register screws under the projector.

The projector can regulate the right and left parable separately, unscrew to lower the light beam, screw to raise the light beam.



5.3.4 Front projector lamps replacement

For the front projector lamps replacement, remove the right and left inspection covers, of the parable, unscrewing the 3 fixing screws.

Remove the burned lamps.



5.4 Adjustments that has to be done by a Benelli Authorized Workshop



WARNING – The following adjustments are reserved to the Benelli Authorized Workshops. Never perform the adjustment while riding. B

5.4.1 Clutch lever play

Remove the adjustment cover cap.
 Unloose the ring nut (A) and reset the clutch lever play by turning the adjustment (B) clockwise or anticlockwise.
 Turn clockwise to decrease the play.
 Turn anticlockwise to increase the play.



5.5 Adjusting the rear suspension



WARNING
 The high temperature of the exhaust pipes can cause burns. Before adjusting the rear suspension, shut off the engine and wait until the exhaust pipes have thoroughly cooled.
 The rear shock absorber contains highly compressed gas. Do not try to open or disassemble it in any way



When you estimate the rear suspension settings, never push or pull in any way on the exhaust muffler and on the tail. They would be certainly damaged.

Check the rear suspension settings in the position indicated by the arrow.

NOTE: At the moment of delivery of the motorcycle, the rear suspension is adjusted in the standard configuration, with damper spring length of 140 mm (5.55 in) [14 mm (0.55 in) of preload].

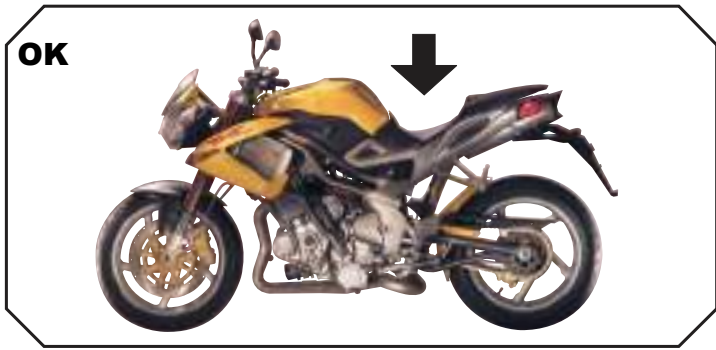



5.5.1 Adjusting rear suspension spring preload

Adjust the spring preload by means of the two ring nuts (A and B) shown in the figure. Unloose the ring nut (A) and adjust the preload using the ring nut (B). Turn clockwise for a stiffer preload. Turn anticlockwise for a softer preload. Once the adjustment is over, tighten the ring nut (A).

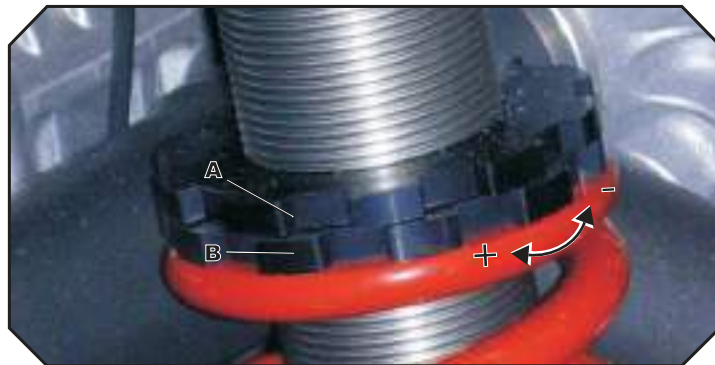

5.5.2 Adjusting rear suspension rebound damper hydraulic device

Adjusting of the rebound damper hydraulic device is made in jerks. Turn the rule (C) clockwise to increase the braking action, or turn anticlockwise to decrease it.

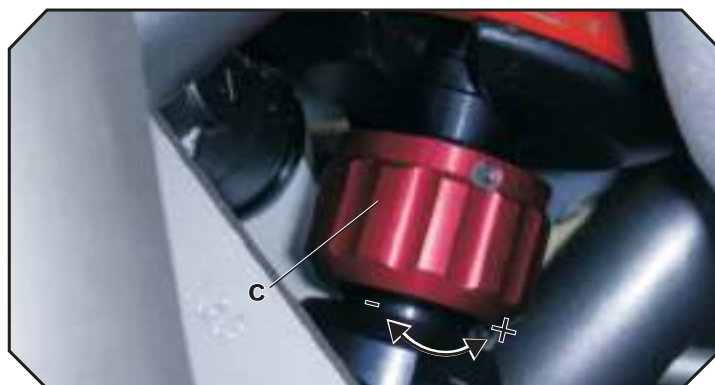

REAR SUSPENSION

	Standard configuration
Spring length	140 mm (5.55 in)
Rebound damper	12 clicks
Spring Preloading	14 mm (0.55 in)

NOTE:

Adjusting of the preload starts from the damper spring length of 140 mm (5.55 in). The compression and rebound adjustment starts from the “all close” position (direction +).

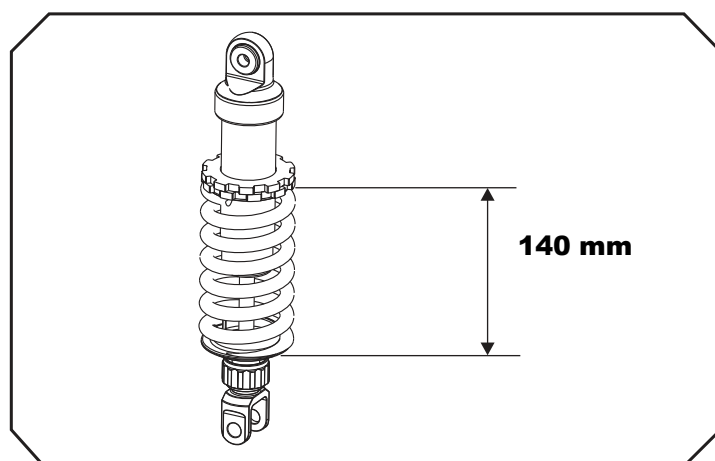



6 Maintenance

6.1 Tables of scheduled maintenance and checks



WARNING

- Improperly or lack of recommended maintenance operations can lead to an increase of the risk of accidents and damage to the motorcycle.
 - Always use genuine Benelli spare parts. Using non-genuine spare parts can accelerate the wear of your motorcycle and shorten its life.
 - Failure to perform the recommended operations, as well as using non-genuine spare parts, can cause the unoperativeness of the legal guaranty.
- To replace or top up the lubricants and fluids of your motorcycle, use only the suitable products.



PROTECT THE ENVIRONMENT

Benelli, in order to protect the interests of the community, awakens the Customers and the Technical Assistance operators to use the vehicle and dispose of its replaced parts respecting the laws in force concerning environmental pollution and waste disposal and recycling.

The main periodic checks and maintenance operations are shown in the following tables. These operations are necessary to keep the motorcycle safe and in perfect running order.



The intervals indicated in the periodic maintenance and lubrication tables must be intended as a general guide under normal riding conditions. It could be necessary to reduce these intervals according to the climate, the ground conditions, the geographic position and the conditions of use.

Some of the operations can be carried out by the user, providing he or she possesses the requisite skills and, however, only when explicitly scheduled in this Owner's Manual. In any other case have the operations performed by a Benelli Authorized Workshop, whose list is available on the web site www.benelli.com or calling the Benelli Customer Service dialling 800342300.



As a rule maintenance operations must be performed while the motorcycle is on the rear stand after switching off the engine and setting the start switch to OFF. On the contrary, while checking the fluid levels it is advisable to keep the motorcycle in an upright position without using the rear stand.

Tables of scheduled maintenance

NOTE: the table below describes all the scheduled maintenance operations. The column "COMPETENCE" indicates (C) who must carry out the operations described:

Legend:

"I" = inspection and adjustment, cleaning, lubrication or replacement according to requirements

"R" = replacement

"T" = tighten

"O" = authorized dealer or personnel

"U" = user





COMPONENTS	C	OPERATION	COVERED			
			0 km (0 mi) predelivery	After 1000 km (600 mi) running-in	Every 5000 km (3000 mi)	Every 10000 km (6000 mi)
Engine oil	U	Check / Restore level	i	Every time vehicle is used		
	O	Replace		R	i	R
			At least once a year			
Engine oil filter	O	Replace		R	i	R
			Every time engine oil is changed			
Coolant	U	Check / Restore level	Every time vehicle is used			
	O	Check / Restore level	i	i	i	i
		Replace	At least every two years			
Cooling system	O	Check for leakage	i	i	i	i
Electric fans	O	Check operation	i	i	i	i
Valves	O	Check / Adjust				i



COMPONENTS	C	OPERATION	COVERED			
			0 km (0 mi) predelivery	After 1000 km (600 mi) running-in	Every 5000 km (3000 mi)	Every 10000 km (6000 mi)
Timing chain	O	Check				i
		Replace	Every 25000 km (15000 mi)			
Timing movable shoe	O	Check / Replace				i
		Replace	Every 25000 km (15000 mi)			
			Every time timing chain is replaced			
Timing chain stretcher	O	Check / Replace				i
Spark plugs	O	Check / Replace		i	i	i
		Replace				R
Fuel filter	O	Check / Replace				R
Air filter	O	Check / Replace		i	i	i
Front sprocket / Tab washer	O	Check		i	i	i
		Replace		i	i	i
			Every time drive chain is replaced			



COMPONENTS	C	OPERATION	COVERED			
			0 km (0 mi) predelivery	After 1000 km (600 mi) running-in	Every 5000 km (3000 mi)	Every 10000 km (6000 mi)
Drive chain	U	Lubricate	Every 1000 km (600 mi) and after riding under the rain			
	O	Check / Adjust	i	i	i	i
		Lubricate		i		
Rear sprocket	O	Replace				R
		Check		i	i	i
	Replace	Every time drive chain is replaced				
Drive chain pads on swingarm	O	Check / Replace		i	i	i
Drive chain pads on frame plate	O	Check / Replace		i	i	i
Fuel lines and connections	O	Check for leakage		i	i	i
		Replace	At least every 3 years			



COMPONENTS	C	OPERATION	COVERED			
			0 km (0 mi) predelivery	After 1000 km (600 mi) running-in	Every 5000 km (3000 mi)	Every 10000 km (6000 mi)
Brakes fluid	U	Check level	Every time vehicle is used			
	O	Check level	i	i	i	i
		Replace	Every 25000 km (15000 mi)			
Clutch control	O	Check		i	i	i
Brakes / Clutch	U	Check operation	Every time vehicle is used			
	O	Check operation	i	i	i	i
Brake pads		Check wear	Every 1000 km (600 mi)			
	O	Check / Replace		i	i	i
Throttle control	U	Check operation	Every time vehicle is used			
	O	Check operation	i	i	i	i
Check / Adjust play		i	i	i	i	
Flexible controls and transmissions	O	Check / Adjust	i	i	i	i



COMPONENTS	C	OPERATION	COVERED			
			0 km (0 mi) predelivery	After 1000 km (600 mi) running-in	Every 5000 km (3000 mi)	Every 10000 km (6000 mi)
Steering head tube ring	O	Check / Adjust		i	i	i
Steering bearings	O	Check / Adjust		i	i	i
		Lubricate	Every 20000 km (12000 mi)			
Tyres	U	Check pressure	Every time vehicle is used; at least every 10 days			
		Check wear	Every time vehicle is used; at least every 500 km (300 mi)			
	O	Check pressure	i	i	i	i
		Check wear		i	i	i
Wheel rims	O	Inspect visually		i	i	i
			Every time tyre is replaced			



COMPONENTS	C	OPERATION	COVERED			
			0 km (0 mi) predelivery	After 1000 km (600 mi) running-in	Every 5000 km (3000 mi)	Every 10000 km (6000 mi)
Front/rear wheel bearings	O	Check			i	i
		Replace	Every time tyre is replaced Every 50000 km (30000 mi)			
Sidestand	U	Check operation	Every time vehicle is used			
	O	Check operation	i	i	i	i
Side stand switch	U	Check operation	Every time vehicle is used			
	O	Check operation	i	i	i	i
Swingarm bearings	O	Replace / Lubricate	Every 35000 km (21000 mi)			
Rear shock absorber	O	Check / Adjust		i	i	i
Front fork oil	O	Replace	Every 20000 km (12000 mi)			
Battery connections	O	Check / Clean		i	i	i
Electrical equipment	O	Check operation	i	i	i	i



COMPONENTS	C	OPERATION	COVERED			
			0 km (0 mi) predelivery	After 1000 km (600 mi) running-in	Every 5000 km (3000 mi)	Every 10000 km (6000 mi)
Instrument panel	U	Check operation	Every time vehicle is used			
	O	Check operation	i	i	i	i
Lights / Visual signals	U	Check operation	Every time vehicle is used			
	O	Check operation	i	i	i	i
Horn	U	Check operation	Every time vehicle is used			
	O	Check operation	i	i	i	i
Headlight	U	Check operation	Every time vehicle is used			
	O	Check operation	i	i	i	i
		Adjust	Every time geometry is changed			
Ignition switch	U	Check operation	Every time vehicle is used			
	O	Check operation	i	i	i	i
Locks	U	Check operation	Every time vehicle is used			
	O	Check operation	i	i	i	i
Screws and nuts	O	Check / Tighten	i	T	T	T



COMPONENTS	C	OPERATION	COVERED			
			0 km (0 mi) predelivery	After 1000 km (600 mi) running-in	Every 5000 km (3000 mi)	Every 10000 km (6000 mi)
Hose clamp	O	Check / Tighten	i	i	i	i
General lubrication	O		i	i	i	i
General test	O		i	i	i	i



6.3 Table of lubricants and fluids

Description	Recommended product
Engine lubrication oil *	15W/50 (Synthetic) JASO - MA CC MC G4
Coolant	READY FOR USE RADIATORS FLUID
Brake and clutch fluid	SPECIAL BRAKE FLUID DOT4
Drive chain lubrication oil	SPRAY GREASE SPECIFIC FOR CHAINS WITH O-RING

* : For the availability of the suggested product, **Benelli** suggests to directly apply to the Authorized Dealers or Workshops. If the above described lubricant is not available, **Benelli** suggests to use a fully synthetic engine oil having characteristics equal or better than the ones prescribed in the following standards:

- API SJ
- ACEA A3
- JASO - MA CC MC G4



6.4 Checking the engine oil level

Check the oil level while the engine is not running, and has been allowed to cool down for at least ten minutes after a ride.

The check must be performed after placing the motorcycle in an upright position on a horizontal surface.

The level must be between the MAX and MIN marks on the crankcase.

If the oil level is below the MIN mark, top up.



Do not start the engine if the oil level is below the MIN mark.





6.4.1 Topping up the engine oil level

To top up the engine oil level, remove the oil filler plug and pour an appropriate amount of engine oil of the recommended type. Never exceed the MAX level mark. At the end of the operation, place back the oil filler plug.



To avoid clutch sliding and damage to the engine, never add chemical additives to the engine oil, nor use an engine oil different from the one specified in the table lubricants and fluids.

Make sure that no foreign body gets in the crankcase while topping up the engine oil.

Oil filler plug



WARNING



New or exhaust engine oil can be dangerous. Engine oil is highly toxic for people and domestic animals. In the event of an engine oil ingestion, immediately call a doctor and do not cause vomiting, in order to avoid inhalation of engine oil in lungs. It has been proved that prolonged contact with engine oil can cause skin cancer on guinea pigs.

Even a brief contact with engine oil can cause skin irritation.

- Keep new or exhaust engine oil out of reach of children and domestic animals.
- While topping up the engine oil, wear a long-sleeved shirt and a pair of water-proof gloves to protect your skin.
- If the engine oil comes in touch with your skin, wash it away with soap and water.
- Correctly recycle or dispose of the exhaust engine oil, in order to avoid environmental pollution.



6.5 Checking the coolant level

Check the coolant level while the engine is off and cold. The check must be performed after placing the motorcycle in an upright position on a horizontal surface.

The level in the cup must be included between the MAX and MIN references

In the case the cooling liquid level is under the MIN reference, remove the cup plug and make a topping up, or bring the motorbike in the closest Benelli authorized machine shop.



Do not start the engine if the coolant level is below the MIN mark.



6.5.1 Topping up the coolant level



WARNING

This operation has to be performed only by a Benelli Authorized Workshop. Perform the topping up of the coolant when the engine is off and cold. Never attempt to remove the coolant filler cap when the engine is hot, in order to avoid the risk of burns. The cooling system is under pressure! Under certain conditions, ethylene glycol contained in the coolant can become flammable.

When it is lighted, it produces an invisible flame.

Avoid spilling coolant on hot parts of the motorcycle, because the subsequent combustion of ethylene glycol could cause serious burns.

Coolant is a highly toxic fluid. Avoid contact and ingestion. Keep coolant out of reach of children and domestic animals. In the event of a coolant ingestion, immediately call a doctor and do not cause vomiting, in order to avoid inhalation of coolant in lungs. If the coolant comes in touch with your skin or eyes, immediately wash it away with water.



To gain access to the coolant filler cap, remove the passenger saddle.

Remove the filler cap and top up using the coolant recommended in the lubricants and liquids table.

After the reset time, reassemble carefully the radiator cap and the closing cover.

Coolant filler cap



Coolant can damage painted and plastic parts.

When you top up the coolant level, be careful not to spill coolant on any part of the motorcycle. If you do spill coolant on your motorcycle, immediately wipe it away using a clean cloth.



6.6 Checking the wear of the brake pads



WARNING

If the brake pads are excessively worn out, the effectiveness of the braking system decreases, increasing the risk of accidents. Check frequently, from a Benelli Authorized Workshop, the wear and tear of the linings and, wherever need, make them replaced.

Ensure that the new pads are suitably broken in.

Limit of the wear and tear of the linings A: 3,5 mm (0.14 in).





6.7 Checking the brake fluid level

WARNING

Lack of maintenance of the braking system can increase the risk of accidents. If you notice any anomaly in the working of the braking system, go immediately to a Benelli Authorized Workshop. Wherever you suspect that can exist a serious failure of the braking system, stop immediately the motorcycle and call the nearest Benelli Authorized Workshop. Never use your motorcycle if the fluid level is below the MIN mark. The brakes may fail to properly operate, which could lead to an accident. If the brake fluid level is below the MIN mark, you must have it topped up by an authorized Benelli dealer.



The level of the brake fluid decreases as the brake pads wear down. Ensure that the fluid level is always between the MAX and MIN marks. If the level falls below the MIN mark, contact a Benelli authorized service center and have the brake system overhauled.

Have the topping up of the brake fluid performed only by Benelli authorized service center.

Brake fluid is highly toxic. Avoid contact and ingestion. Keep brake fluid out of reach of children and domestic animals. In the event of a brake fluid ingestion, immediately call a doctor and do not cause vomiting, in order to avoid inhalation of brake fluid in lungs. If the brake fluid comes in touch with your skin or eyes, immediately wash with water.

Use only the brake fluid specified in the table lubricants and fluids of this manual.

Mixing different brake fluids can cause a dangerous chemical reaction, as well as the decrease of the braking efficiency, with subsequent increase of the risk of accidents.

An insufficient amount of brake fluid may allow the introduction of air in the braking system. This could compromise the effectiveness of the braking system, with subsequent increase of the risk of accidents.

Presence of air in the braking system can be identified in the moment you feel a characteristic “spongy effect” while pushing the brake pedal. In this case, have a braking system bleeding performed by an authorized Benelli dealer before riding your motorcycle again.



6.8 Checking the tires and rims



WARNING
Before using the motorcycle, always check the pressure and wear of the tyres. An incorrect inflating pressure can lead to dangerous situations during riding. An insufficiently inflated tyre can cause the sliding of the tyre on the wheel rim or its detachment; this may lead to the deflation of the tyre with subsequent loss of control of the vehicle.

Checking the inflating pressure of the tyres is an essential requirement to ensure driving safety. Insufficiently inflated tyres can reduce the handling of the motorcycle and wear themselves out very quickly. On the other hand, an excessively high inflating pressure reduces the wideness of the surface in contact with the ground, and it can compromise the grip of the vehicle. Before riding your motorcycle, it is therefore necessary to measure the tyre pressure at room temperature. The vehicle must be parked since three hours at least.



Check the pressure according to the values indicated in the table below:

	Pressure
Front cool tyre	250 kPa [2,5 bar (36.25 psi)]
Back cool tyre	250 kPa [2,2 bar (31.9 psi)]

In the event of long travels, you can increase the face value of the tyre pressure of 0.2 bar. It is extremely important to check the wear of the tyres before riding. In fact, a worn out tyre can be punctured more easily than a new one, and it can adversely affect handling and stability of the motorcycle. Check that the depth of the tyre tread is not below the values prescribed by the Highway Code. Verify the absence of crevices at the bottom of the tread design and fissures on the tyre sidewall. Moreover, verify the absence of nails and glass splinters in the tyre. If these conditions are not verified, have the tyre replaced by an authorized Benelli dealer.



If a tyre is punctured it must be replaced, not repaired. A repaired tyre provides a restricted performance and lower safety levels than a new one. If you make a provisional or emergency repair to a tyre, you must ride at very low speed until you reach the nearest Benelli authorized service center and have the tyre replaced. With a provisionally repaired tyre, never exceed 60 km/h (37.2 Mph). Tyre repairing must never be performed if the tyre is punctured on its sidewall, or if the diameter of the puncture on the tread is greater than 6 mm (0.23 in).



When it is necessary to replace the tyres, use only the type specified in the technical data table. Moreover, avoid using tyres of a different brand or type on the front and on the rear wheel at the same time. Using tyres different from those specified can adversely affect the handling and stability of the motorcycle, increasing the risk of accidents.

- The wheel rims of your motorcycle have been designed for use with tubeless tyres only. Do not assemble an air tube tyre on rims designed for tubeless tyres. Otherwise, the tyre bead could not properly settle down on the wheel rim, leading to the deflation of the tyre and the loss of control of the vehicle.
- Have the tyres replaced according to their direction of spin, which is highlighted by a small arrow on the tyre sidewall.
- New tyres should be run in for a short period before demanding their full performance. In fact, during this period the tyres could have a reduced grip on some kind of roads. We suggest to ride at reduced speed and exercise extreme caution during the first 100 km (62.5 mi) after the replacement of a tyre.

6.8.1 Checking of the rims and the wheel rims

Before riding, always verify the absence of cracks, bending or buckling on the wheel rims.



WARNING

If you find that the wheel rim is damaged, have it replaced by a Benelli authorized service center. Never attempt to repair the wheel rim, even in case of slight damage.

Every time you replace a tyre or a rim, you must have a wheel balancing performed.

Wheel unbalance can adversely affect performance and handling of the motorcycle, as well as shorten the life of the tyres.



6.9 Cleaning checking and lubricating the drive chain

To perform this operation, you must put the motorcycle on the rear stand, upright on a horizontal surface and with the gear in neutral.

Never try to repair or replace a drive chain. It is a complex and particularly dangerous operation and, therefore, it has to be performed by the Benelli authorized service centers.



WARNING

Riding your motorcycle when the drive chain is in poor condition or improperly adjusted can lead to accidents. If you notice any anomaly in the working of the drive chain, like suspected noises or excessive loose of the chain, go immediately a Benelli authorized service center. Wherever you suspect that can exist a serious failure of the drive chain, stop immediately the motorcycle and call the nearest Benelli authorized service center. Every time the chain is replaced, you must always replace the front and rear sprockets too.

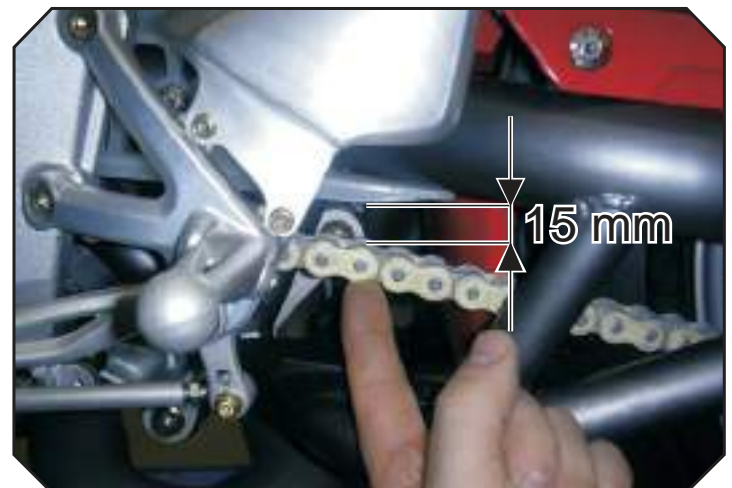



6.9.1 Cleaning

The chain of *TNT* is of the O-ring type. To prevent it from damaging, never clean the chain with a steam or high pressure water jet, nor using gasoline or other solvents.

The chain must be cleaned using kerosene only.

Kerosene is highly toxic and flammable.

Avoid contact and inhalation.

Keep kerosene away from sparks and flames.

Keep kerosene out of reach of children and domestic animals.

Correctly dispose of exhaust kerosene, in order to avoid environmental pollution.

If you are not sure that you can use kerosene in complete safety, don't use it and, when you can go to a Benelli authorized service center ask for the drive chain cleaning.

6.9.2 Lubrification

Chain lubrication has to be performed only by a Benelli authorized service center according to the intervals specified in the tables of scheduled maintenance.

It is also necessary to perform this operation after riding under the rain and after cleaning the motorcycle.

Riding your motorcycle when the drive chain is in poor condition or improperly adjusted can lead to accidents.

To ensure proper operation, the drive chain needs to be properly lubricated.



6.10 Checking the idle speed

The idle speed should range from 1200 to 1300 rpm.

If a tune-up is necessary, contact an authorized service centre.



6.11 Replacing the fuses

The replacement of the fuses has to be performed only by a Benelli authorized service center. Only in case of extreme urgency and if it is not possible to have a specialized technical assistance, the operation can be carried out by the owner according to the indications provided below.



Turn the ignition key on the "OFF" position before checking or replacing the fuses, in order to avoid a short circuit with subsequent damage to other electric parts of the motorcycle.

The recharge fuse is located on the left side of the motorcycle, in the position shown in the figure.

The service fuses are found under the passenger saddle; remove the saddle to gain access to the fuses.

Remove the glovebox.

Replace the blown fuse and refit the cover. To identify the function of the fuses, refer to the information shown on the adhesive label.

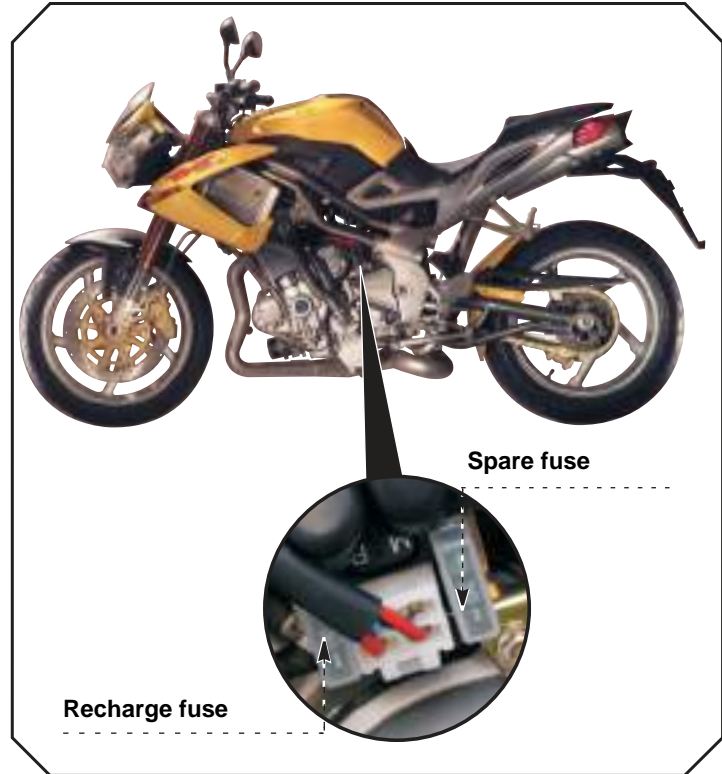

Spare fuses 10A

Reserve fuel

Cooling fans

General

Injectors

Lights

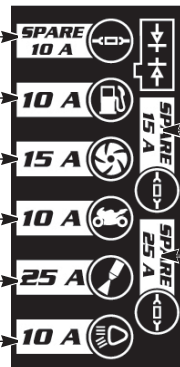

Spare fuses 15A

Spare fuses 15A



WARNING

Never replace a fuse with a rating other than that prescribed, in order to avoid damage to the electrical equipment of the motorcycle which could lead to a fire.



6.12 Battery

The battery is of the maintenance-free type and is installed under the saddles, between the driver saddle and the passenger saddle.

This battery does not require checking of the fluid level or adding of distilled water.

If the battery seems to be run-down (causing electrical problems or a difficult starting), have it recharged by an authorized Benelli dealer as soon as possible. Remember that the battery runs down more quickly if your motorcycle is equipped with additive electrical accessories.

Always have the battery replaced by a Benelli authorized service center.

WARNING



If the battery casing is damaged, there may be a leakage of sulphuric acid, a highly toxic and corrosive substance. Avoid any contact with your eyes, skin and clothes.

Always wear protective glasses when you have to work near the battery.

In the event of a contact with sulphuric acid, give the FIRST AID as described below:

- **CONTACT WITH SKIN: Wash away with a great amount of water.**
- **INGESTION: Drink great amounts of water or milk, and immediately call a doctor.**
- **CONTACT WITH EYES: Wash away with water for about 15 minutes, and immediately call a doctor.**

Furthermore, leakage of sulphuric acid can result in the formation of hydrogen gas which, if ignited by a spark or a flame, would cause an explosion.



The inversion of the battery wires can damage the battery and the recharging system.

The red wires must be connected to the positive terminal (+), while the black wires must be connected to the negative terminal (-).

If the motorcycle is to remain unused for a long time (a month or longer), it is advisable to disconnect the battery cables or have the battery removed by skilled personnel. In case of prolonged inactivity, to avoid shortening the life of the battery, it is essential to have it recharged by a Benelli authorized service center every 4-5 months, in order to guarantee its life in time.

6.13 Cleaning the motorcycle

Periodic careful cleaning is a key factor in preserving the value of the motorcycle, protecting its surface finish and checking for damages, wear and leakage of corrosive fluids.

Wash the motorcycle with water, a mild detergent and a sponge. Wipe the vehicle with a soft cloth. Use an air jet to dry difficult-to-reach areas.

Periodically treat the paintwork with high quality wax. After riding on roads treated with corrosive substances (salt), wash the vehicle as soon as possible with cold water. Do not use hot water as it enhances the corrosive action.





Do not wash your motorcycle soon afterwards riding. Attend a few minutes to allow the engine and the exhaust pipes to thoroughly cool.



Before washing the vehicle, stop up the exhaust pipes and protect the electrical parts. Never use washing systems involving steam or high pressure water jets. These systems could cause water infiltration and damage the internal parts of your motorcycle. Avoid cleaning the rims with fuel or solvents. Avoid using clothes or sponges that have been in contact with strong or abrasive detergents, solvents or gasoline. To avoid irreparable damage to the front fairing, never use alkaline or strongly acid detergents, petrol, brake fluid or other solvents. Clean the front fairing only with a soft cloth, warm water and a neutral detergent.



WARNING

Avoid smearing brakes or tyres with oil or wax. The presence of water on the brakes can lead to a decrease of the braking effectiveness with subsequent risk of accidents. After completing the washing, run the engine for a few minutes and start off at reduced speed. Carefully apply the brakes a few times so as to dry the brake pads and discs.



6.14 Prolonged inactivity

If the motorcycle is not to be used for a long period, contact a Benelli authorized service center to have the following operations carried out:

- Empty the fuel tank.
- Remove the battery and store it in a suitable place.
- Remove the spark plug caps and the spark plugs. Pour a teaspoonful of engine oil in every spark plug hole, then place back the spark plugs and the corresponding caps. Make the engine run idle for a few times.
- Lubricate all control cables and the joints of all pedals and levers.
- Clean the motorcycle and treat the paintwork with high quality wax.
- Park your motorcycle in a fresh, dry and dark place, with a temperature relatively constant and lower than 25° C (77°F). Avoid direct contact of the tyres with heating pipes or radiators, and prolonged contact with oil or gasoline. Avoid parking with the tyres near to electrical motors or devices capable to produce sparks or electric discharge. During the period of inactivity, place your motorcycle on the rear stand.
- Cover the vehicle with an adequate canvas cover **Benelli** that can be bought as optional.



When the motorcycle is used the first time, carry out a general check and have it serviced at an authorized service center.





7 Technical information

Benelli Spa reserves the right to make any changes to its models on the purpose of constantly conform them to the technological advance.

Therefore the technical data that are shown below, can be different from those that can be checked on the vehicle. Moreover some data, like the performance, are susceptible of alteration in function of the specific recording conditions besides, of course, in function of the typical performance of every vehicle.

7.1 Specifications

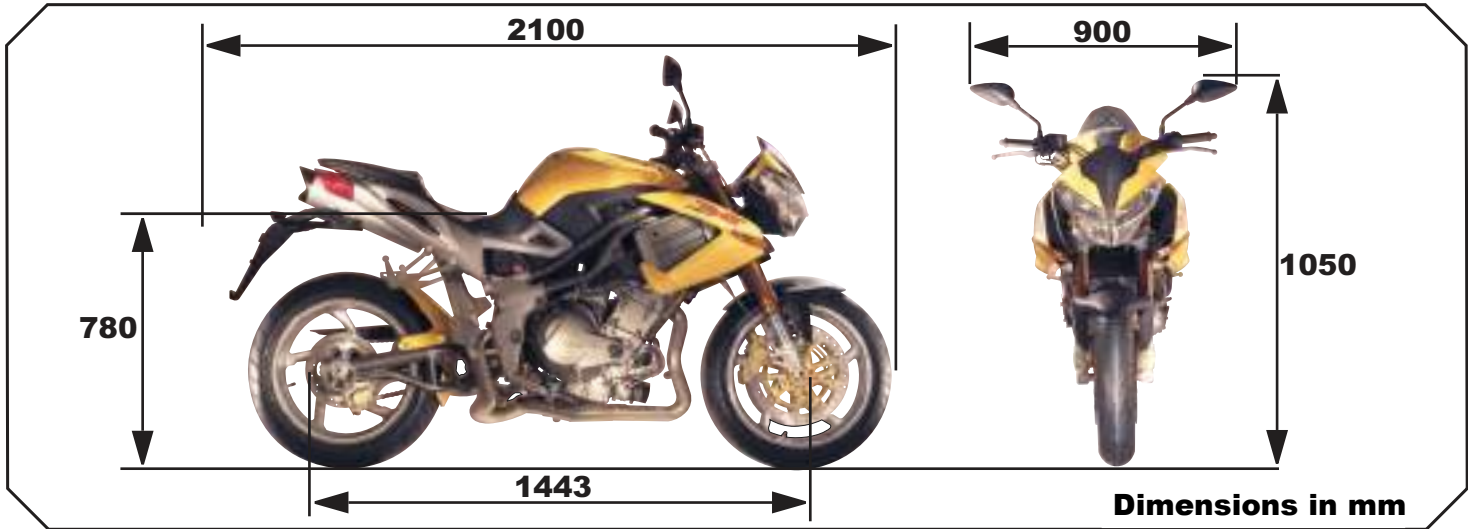

DIMENSIONS	
Overall length	2100 mm (82.7 in)
Max. width	900 mm (35.4 in)
Max. height	1050 mm (41.4 in)
Seat height	780 mm (30.7 in)
Wheelbase	1443 mm (56.8 in)

WEIGHT	
Empty weight (without fuel)	205 kg (451.9 Lbs)
Weight with fuel	215 kg (474 Lbs)
Maximum weight technically acceptable with pilot, passenger and loading.	400 kg (882 Lbs)

ENGINE	
Type	four-stroke 12 valves DOHC
Displacement	1130 cc
Number of cylinders	3
Cylinders position	aligned inclined by 15° forward
Bore stroke	88 x 62 mm (3.5 X 1.94 in)
Compression ratio	11.2±0.5:1
Idle speed	1350 rpm
Distribution	Double-overhead camshaft
Starting	Electric starter
Clutch	Oil bath
Lubrication	Wet sump
Cooling	With water radiator to air-cool oil
Filter oil	Polyurethan dry sponge



Maximum net power	101 KW (135CV) to 9500 rpm
Maximum net torque	110 Nm to 7750 rpm

FUEL	
Recommended fuel	Lead-free premium petrol
Fuel tank capacity	16.5 lt (4.4 Gal)
Reserve fuel	5 lt (1.3 Gal)

ENGINE OIL	
Recommended oil	API SJ 15W/50 (Synthetic) JASO - MA CC MC G4
Total	4 lt (1 Gal)
Quantity without oil filter cartridge replacement	3.8 lt (0.8 Gal)

IGNITION - POWER SUPPLY	
Type	“VALBRO TDD“ integrated ignition-injection system. Inductive discharge electronic ignition, “Multipoint” electronic injection.
Spark plug	CHAMPION RG4HC\ NGK CR9E
Spark gap	0,7 ÷ 0,8 mm (0.028 ÷ 0.032 in)

TRASMISSIN	
Primary	
Number of teeth on crankshaft gear	Z = 44
Number of teeth on clutch gear	Z = 79
Transmission ratio	1.795



Secondary	
Number of teeth on front sprocket	Z = 16
Number of teeth on rear sprocket	Z = 41
Transmission ratio	2.563

Gear ratio in fourth (overall ratio)	1.304 (6.000)
Gear ratio in fifth (overall ratio)	1.167 (5.367)
Gear ratio in sixth (overall ratio)	0.926 (4.260)

GEAR SPEED	
Type	Removable, six-speed gearbox with constantmesh gears
Gear ratio in first (overall ratio)	2.786 (12.816)
Gear ratio in second (overall ratio)	1.994 (8.946)
Gear ratio in third (overall ratio)	1.524 (7.010)

FRAME	
Type	Steel-aluminium mixed solution

SUSPENSIONS	
Front	
Type	“Upside down” telescopic hydraulic fork
Rod diameter	50 mm
Travel range	120 mm (4.7 in)



Rear	
Type	Progressive, with mono shock absorber which can be in extension regulated, spring-loaded.
Swingarm	Steel trestle
Wheel travel range	115 mm (4.5 in)

BRAKES	
Front	
Type	Double steel floating disc
Disc diameter	320 mm (12.6 in)
Disc flange	Aluminium alloy
Pincers	2-piston

Rear	
Type	Single steel disc
Disc diameter	240 mm (9.5 in)
Caliper	2-piston
Calipers, piston diameters	32 mm (1.3 in)

RIMS	
Front	
Type	Five spokes
Material	Radiator pincers
Dimensions	3,50" x 17"
Rear	
Type	Five spokes
Material	Radiator pincers
Dimensions	6,00" x 17"



TYRES	
Front	
Type	Tubeless
Dimensions	120/70 - ZR 17 (58 W)
Maximum inflating pressure	250 kPa 2,8 bar
Rear	
Type	Tubeless
Dimensions	190/55 - ZR 17 (73 W)
Maximum inflating pressure	2,8 bar

ELECTRICAL EQUIPMENT	
Equipment voltage	12V
Low beam	12V - 55W
High beam	12V - 55W
Front light	12V - 5W
Rear light - Brake light	12V - 21W
Front turn indicators	12V - 3 x 5W
Battery	12V - 10 Ah
Alternator	480W to 5000 rpm





VARIANTS

This section is dedicated to all the variants included in the TnT Sport and Titanium.

TnT Sport

TITANIUM



8.1 Adjusting the front suspension

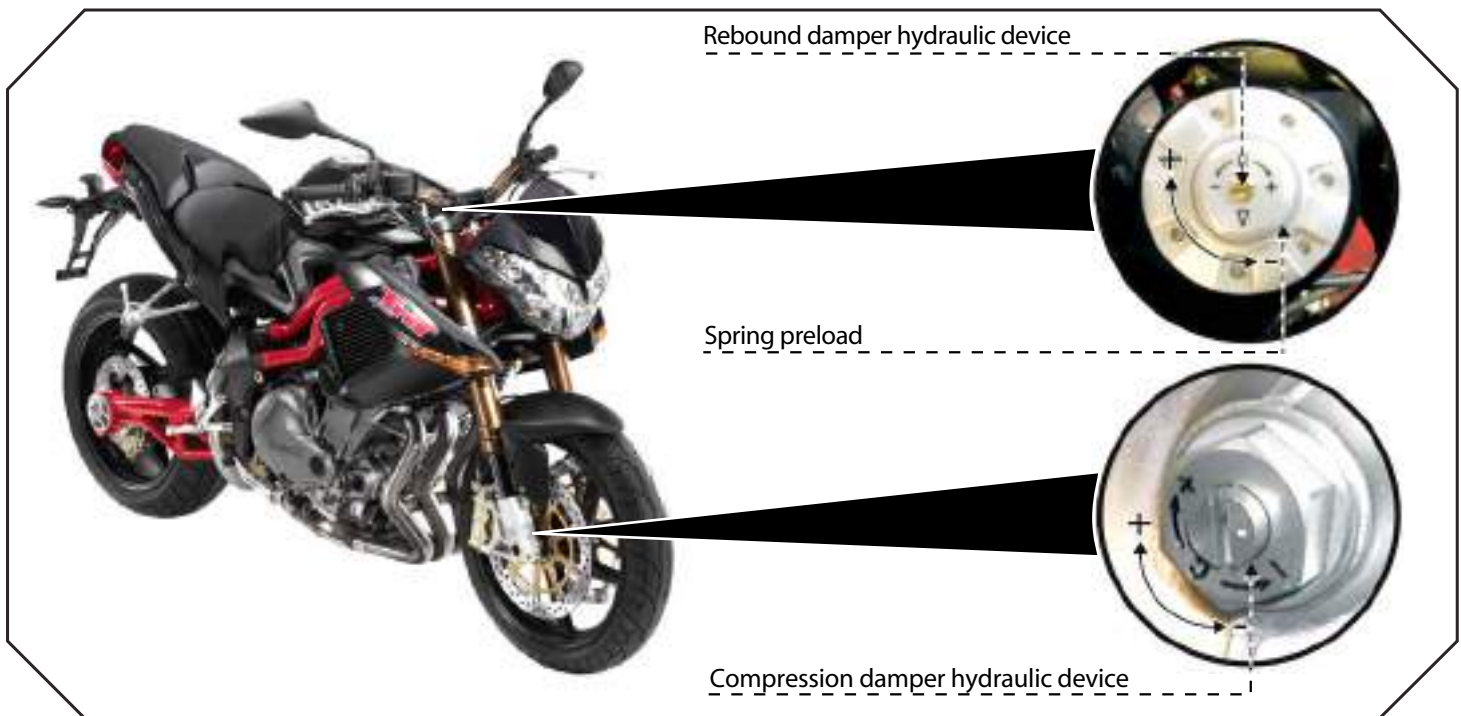

8.1.1 Adjusting front suspension spring preload

Adjusting of the spring preload is performed by counting the rule turns (A), either clockwise and anticlockwise. Turn clockwise for stiffer preload adjustment. Turn anticlockwise for softer preload adjustment.

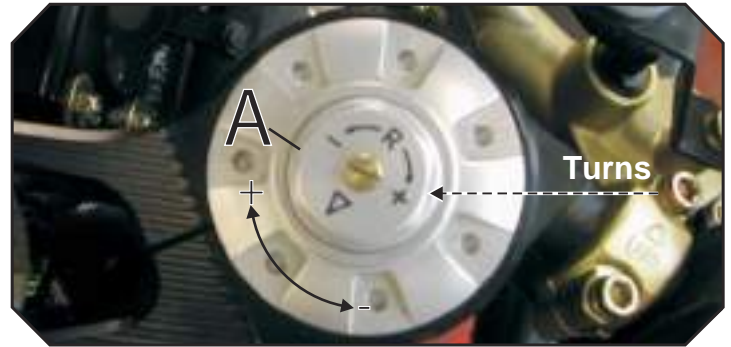

WARNING
It is essential that the adjusters of both fork rods are adjusted to the same position.

8.1.2 Adjusting front suspension rebound damper hydraulic device

Adjusting of the rebound damper hydraulic device is made in jerks. Turn the rule (B) clockwise to increase the braking action, or turn anticlockwise to decrease it.

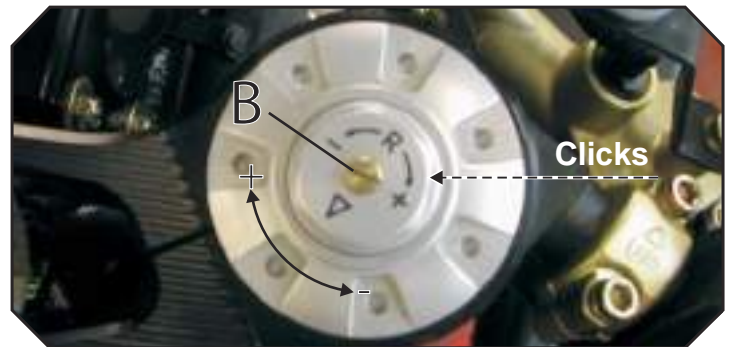

8.1.3 Adjusting front suspension compression damper hydraulic device

Adjusting of the compression damper hydraulic device is made in jerks. Turn the rule (C) clockwise to increase the braking action, or turn anticlockwise to decrease it.



FRONT SUSPENSION	Standard
Spring preload	7 giri
Rebound damper	3 giri
Compression damper	2 giri

FRONT SUSPENSION	Sport
Spring preload	7 giri
Rebound damper	1 giri
Compression damper	1½ giri

NOTE:
Start adjusting the preload from the “all open” position (direction -).
The compression and rebound adjusting starts from the “all close” position (direction +).

8.2 Adjusting the rear suspension

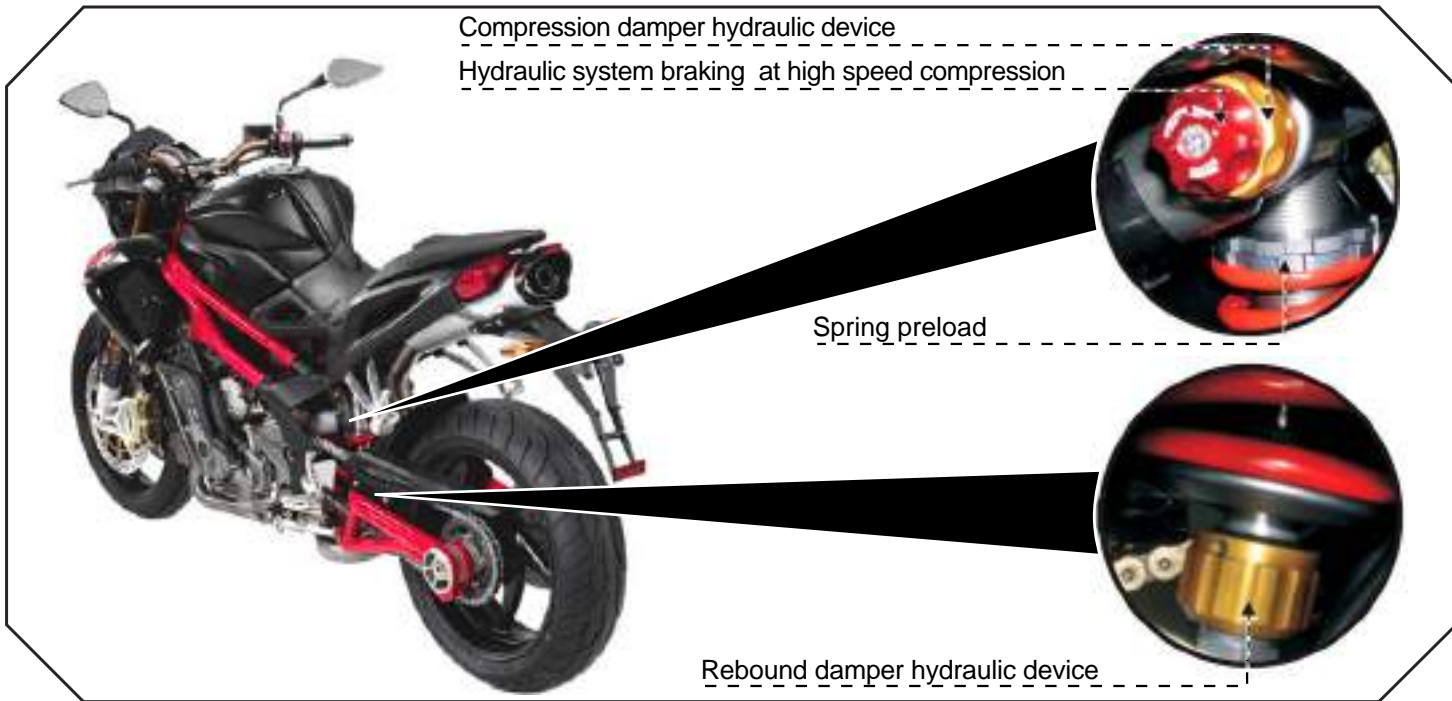

WARNING
The high temperature of the exhaust pipes can cause burns. Before adjusting the rear suspension, shut off the engine and wait until the exhaust pipes have thoroughly cooled. The rear shock absorber contains highly compressed gas. Do not try to open or disassemble it in any way.



When you estimate the rear suspension settings, never push or pull in any way on the exhaust muffler and on the tail. They would be certainly damaged.

Check the rear suspension settings in the position indicated by the arrow.

NOTE: At the moment of delivery of the motorcycle, the rear suspension is adjusted in the standard configuration, with damper spring length of 141 mm (5.55 in) [11 mm (0.43 in) of preload].



8.2.1 Adjusting rear suspension spring preload

Adjust the spring preload by means of the two ring nuts (A and B) shown in the figure. Unloose the ring nut (A) and adjust the preload using the ring nut (B). Turn clockwise for a stiffer preload. Turn anticlockwise for a softer preload. Once the adjustment is over, tighten the ring nut (A).

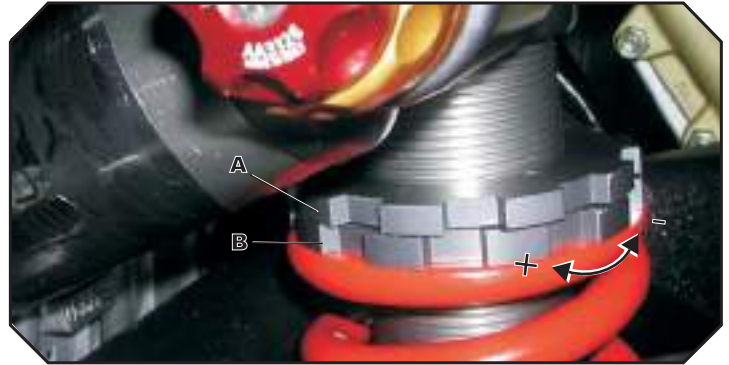

8.2.2 Adjusting rear suspension rebound damper hydraulic device

Adjusting of the rebound damper hydraulic device is made in jerks. Turn the rule (C) clockwise to increase the braking action, or turn anticlockwise to decrease it.

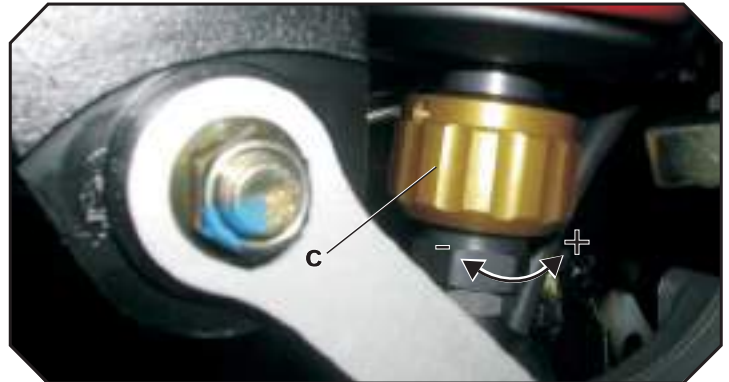

8.2.3 Adjusting rear suspension compression damper hydraulic device

Adjusting of the compression damper is made in jerks. Turn the rule (D) clockwise to increase the braking action, or turn anticlockwise to decrease it.



8.2.4 Hydraulic compression braking system at high-speed back - wheel suspension

Adjusting of the compression damper is made in jerks. Turn the rule (E) clockwise to increase the braking action, or turn anticlockwise to decrease it.



REAR SUSPENSION	Standard
Spring length	141 mm (5.55 in)
Rebound damper	24 clicks
Compression damper	17 clicks
High speed compression braking	12 clicks

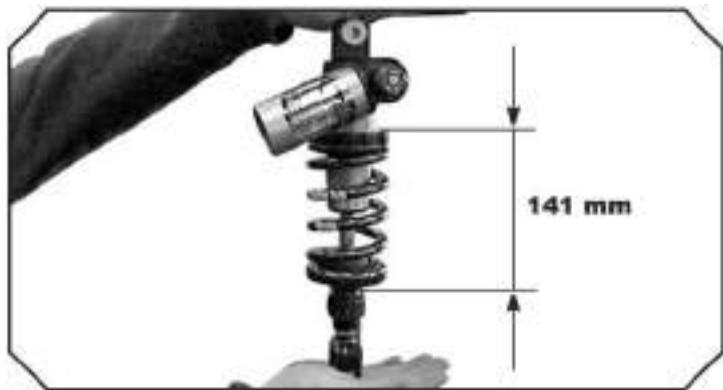

REAR SUSPENSION	Sport
Spring length	141 mm (5.55 in)
Rebound damper	22 clicks
Compression damper	9 clicks
High speed compression braking	7 clicks

NOTE:
 Adjusting of the preload starts from the damper spring length of 141mm (5.55 in).
 The compression and rebound adjustment starts from the "all close" position (direction +).

9.1 Power Control System

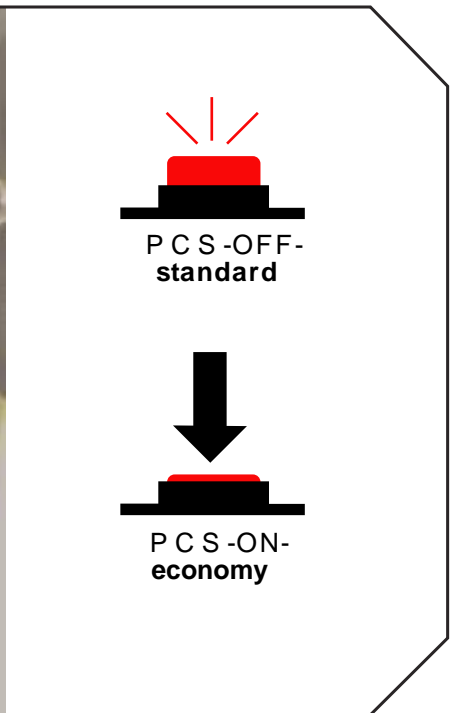



9.1.1 Power Control System Activation

This system allows to select two different settings of the tune:

STANDARD:

With button in OFF position (light on) the engine performs 137hp (101 KW *)

ECONOMY:

With button in ON position (light off) the engine performs 112 hp (82 KW*) allowing a more linear distribution, a decreased fuel consumption included between 10% and 20 % depending on the road. In particular way it allows an easier control of the bike in low grip condition of the road.



WARNING:
Do not activate the Power Control System when the bike is running.

* For countries having power limits standard tune 72 kW.



This Manual is property of Benelli Spa.
Any total or partial reproduction is forbidden.



Version 2005 / 01
Benelli Spa
Strada della Fornace Vecchia
61100 - Pesaro - ITALY
www.benelli.com